



AMP Signal Double Lock

TE Internal #: 2005543-5

Rectangular Connector Locking, Double Lock Plate, UL 94V-0, -30 – 105 °C [-22 – 221 °F], AMP Signal Double Lock

[View on TE.com >](#)

Connectors > Rectangular Connectors > Rectangular Connector Accessories > Locking

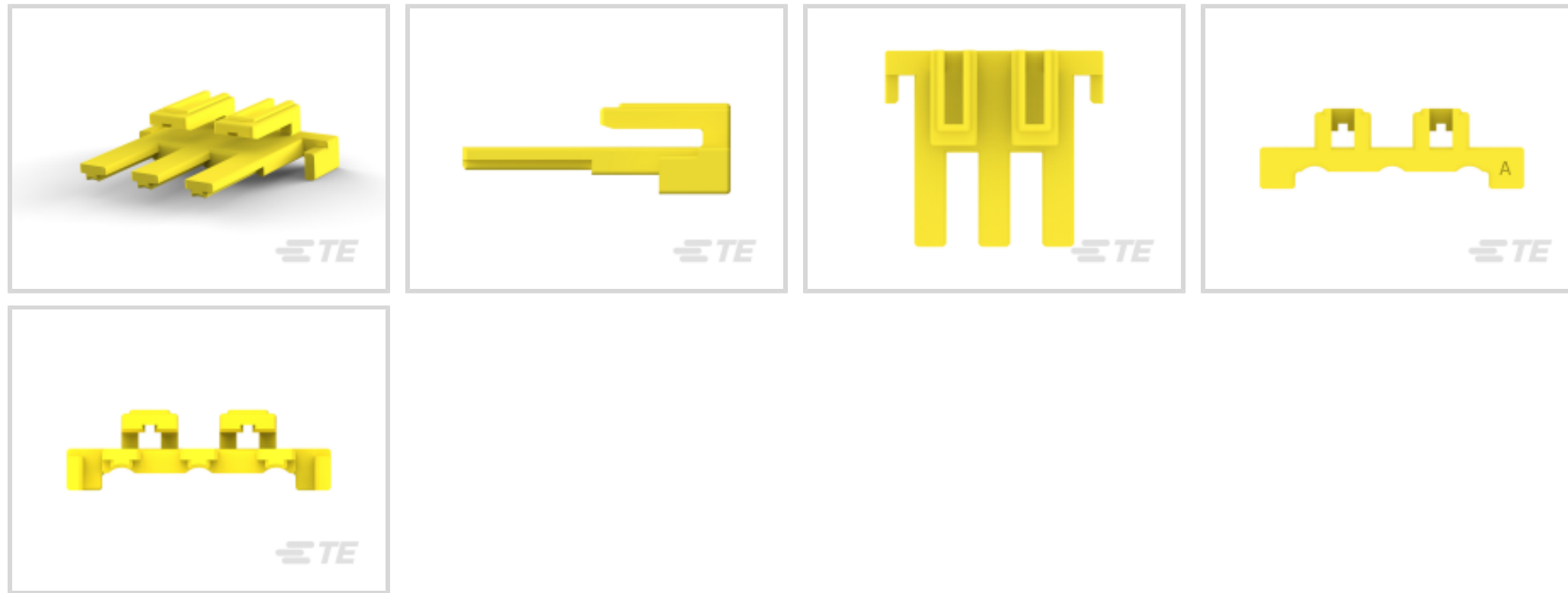

Connector & Contact Retention Accessory Type: **Double Lock Plate**

UL Flammability Rating: **UL 94V-0**

Operating Temperature Range: **-30 – 105 °C [-22 – 221 °F]**

Features

Product Type Features

Product Type	Accessory
Connector & Contact Retention Accessory Type	Double Lock Plate

Usage Conditions

Operating Temperature Range	-30 – 105 °C[-22 – 221 °F]
-----------------------------	----------------------------

Industry Standards

UL Flammability Rating	UL 94V-0
------------------------	----------

Product Compliance

[For compliance documentation, visit the product page on TE.com>](#)

EU RoHS Directive 2011/65/EU	Compliant
EU ELV Directive 2000/53/EC	Compliant
China RoHS 2 Directive MIIT Order No 32, 2016	No Restricted Materials Above Threshold
EU REACH Regulation (EC) No. 1907/2006	Current ECHA Candidate List: JUNE 2022 (224) Candidate List Declared Against: JAN 2021 (211) SVHC > Threshold: Not Yet Reviewed

Halogen Content

Not Low Halogen - contains Br or Cl > 900 ppm.

Solder Process Capability

Not reviewed for solder process capability

Product Compliance Disclaimer

This information is provided based on reasonable inquiry of our suppliers and represents our current actual knowledge based on the information they provided. This information is subject to change. The part numbers that TE has identified as EU RoHS compliant have a maximum concentration of 0.1% by weight in homogenous materials for lead, hexavalent chromium, mercury, PBB, PBDE, DBP, BBP, DEHP, DIBP, and 0.01% for cadmium, or qualify for an exemption to these limits as defined in the Annexes of Directive 2011/65/EU (RoHS2). Finished electrical and electronic equipment products will be CE marked as required by Directive 2011/65/EU. Components may not be CE marked. Additionally, the part numbers that TE has identified as EU ELV compliant have a maximum concentration of 0.1% by weight in homogenous materials for lead, hexavalent chromium, and mercury, and 0.01% for cadmium, or qualify for an exemption to these limits as defined in the Annexes of Directive 2000/53/EC (ELV). Regarding the REACH Regulation, the information TE provides on SVHC in articles for this part number is based on the latest European Chemicals Agency (ECHA) 'Guidance on requirements for substances in articles' posted at this URL: <https://echa.europa.eu/guidance-documents/guidance-on-reach>

Compatible Parts



TE Part # CAT-SI261-T669
Signal Double Lock TPA



TE Part # CAT-526SDL-SEALTP
2.5mm Sealed Connector: TPAs,
Signal Double Lock Connectors



TE Part # 5-917698-1
2.5 SIGNAL DBL LOCK D.L.P 2P

Also in the Series | AMP Signal Double Lock

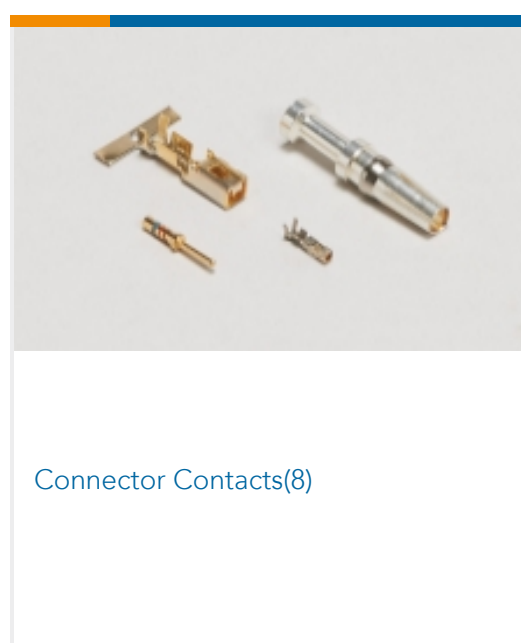

Connector Contacts(8)

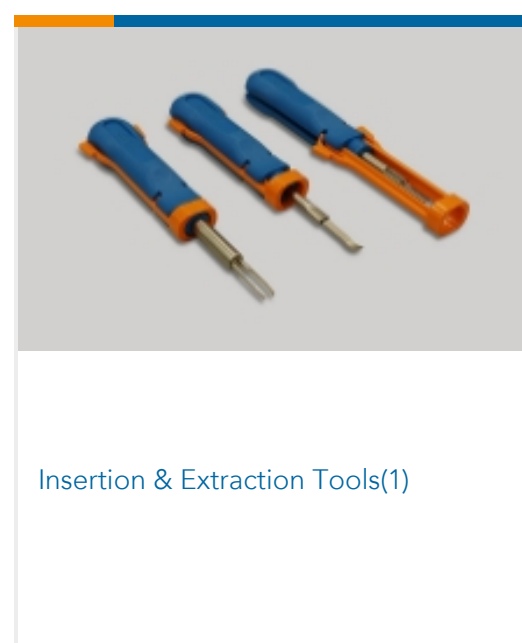

Insertion & Extraction Tools(1)



PCB Connector Seals(1)



PCB Headers & Receptacles(145)

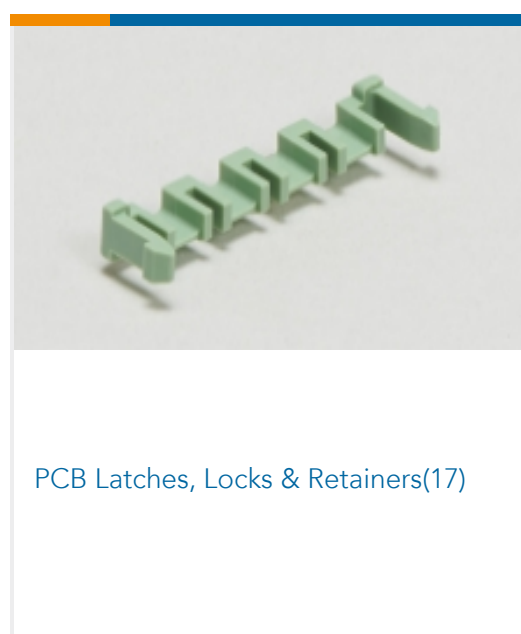

PCB Latches, Locks & Retainers(17)

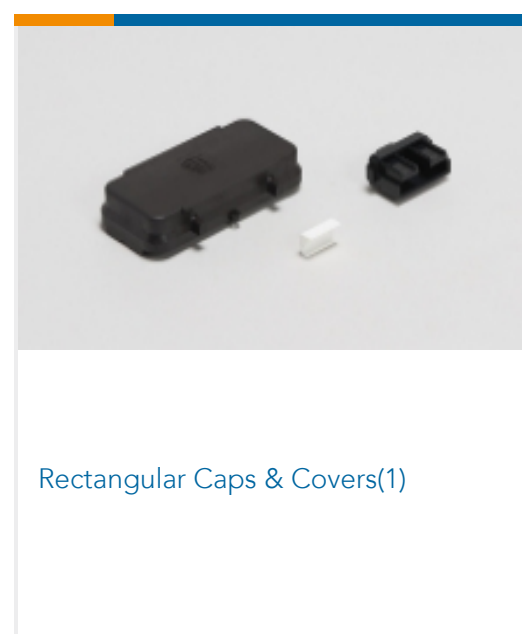

Rectangular Caps & Covers(1)

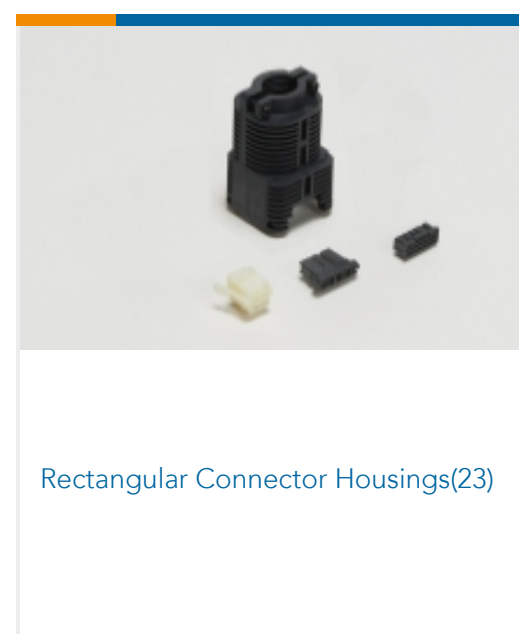

Rectangular Connector Housings(23)

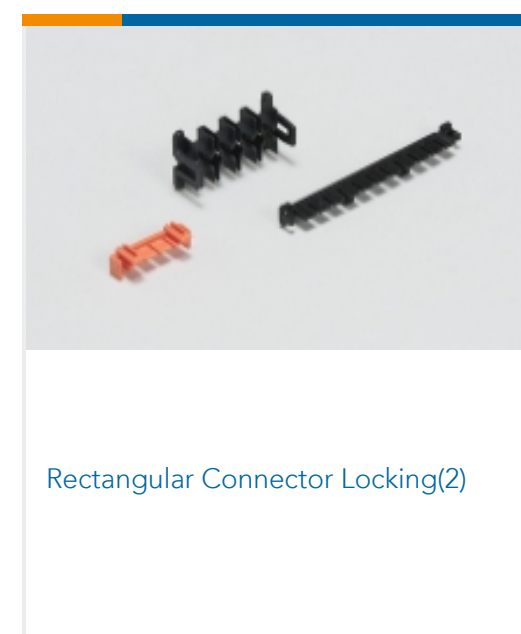

Rectangular Connector Locking(2)

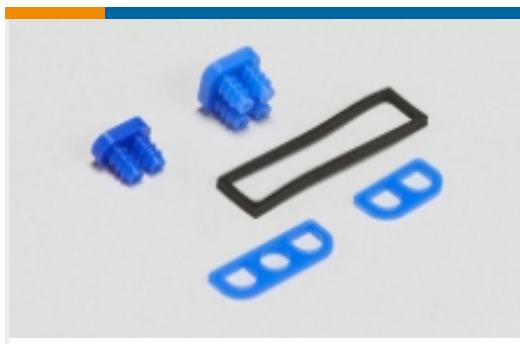

Rectangular Connector Seals(10)



Rectangular Power Connectors(3)

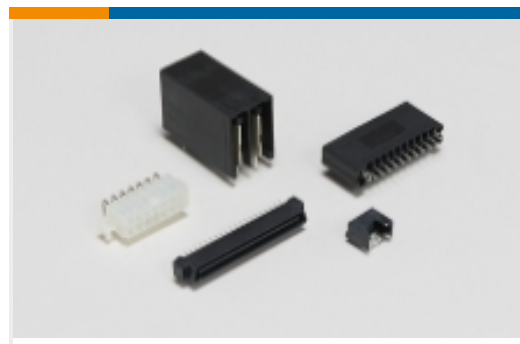

Standard Rectangular Connectors(1)

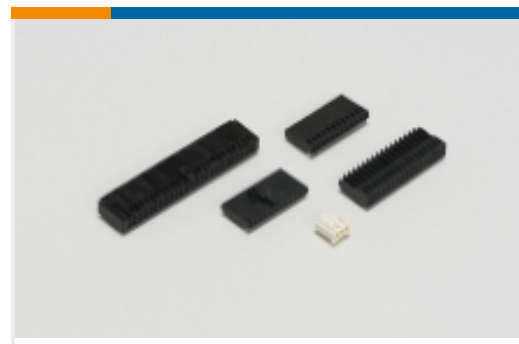

Wire-to-Board Connector Assemblies & Housings(74)



Wire-to-Board Connector Contacts(6)

Customers Also Bought



TE Part #917705-1
Signal Double Lock TPA



TE Part #177916-1
AMP POWER DBL LOCK TAB (S)



TE Part #2232342-1
187 PL EX FLAG REC. 22-16AWG PTBR



TE Part #5-179464-1
POWER DBL LOCK CAP HSG F/H 3P (GWT)

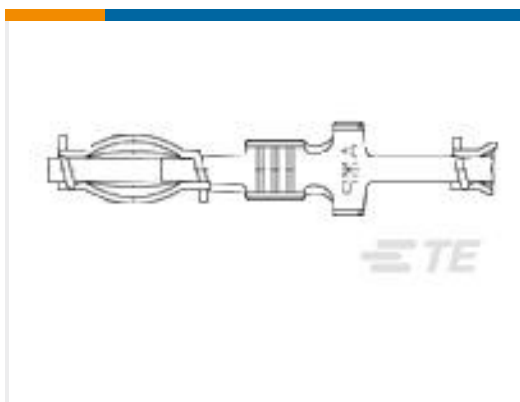

TE Part #5-170063-2
CLUSTER REC



TE Part #1-1743165-2
250 HSG. PL EX REC. 12mm 2P BLACK

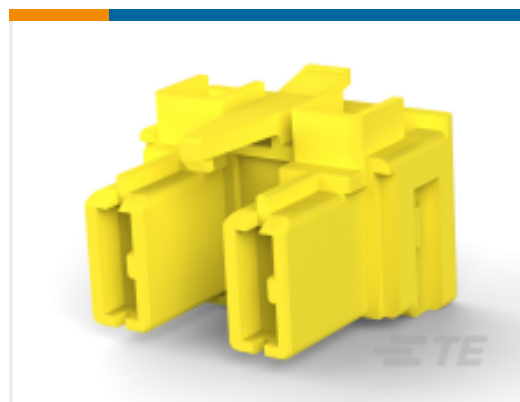

TE Part #1-1743165-5
250 HSG. PL EX REC. 12mm 2P YELLOW



TE Part #2-2005820-9
CLUSTER BLOCK 3P CLIP HSG(GWT)

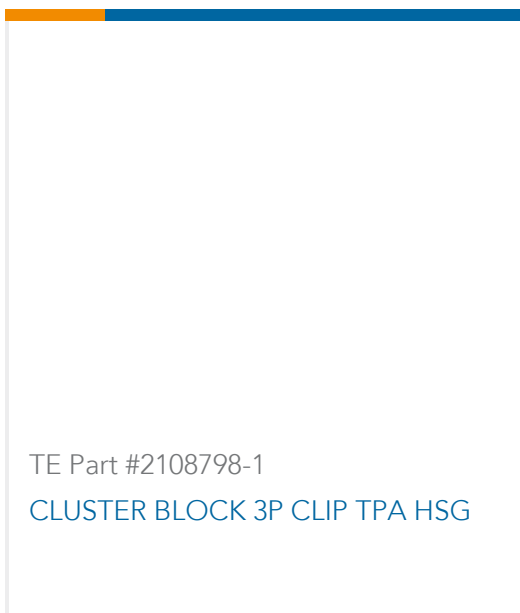

TE Part #2108798-1
CLUSTER BLOCK 3P CLIP TPA HSG

Documents



Product Drawings

BLOWER MOTOR 3P DBL YEL

English

CAD Files

3D PDF

3D

Customer View Model

[ENG_CVM_CVM_2005543-5_A_c-2005543-5-a.2d_dxf.zip](#)

English

Customer View Model

[ENG_CVM_CVM_2005543-5_A_c-2005543-5-a.3d_igs.zip](#)

English

Customer View Model

[ENG_CVM_CVM_2005543-5_A_c-2005543-5-a.3d_stp.zip](#)

English

By downloading the CAD file I accept and agree to the [Terms and Conditions](#) of use.

Product Specifications

Product Specification

English

Product Environmental Compliance

[MD_2005543-5_11012017353_dmtec](#)

English

[MD_2005543-5_11012017353_dmtec](#)

English

Agency Approvals

Agency Approval Document

English