

1971845-3 ✓ ACTIVE

RAST | RAST 5 IDC Connectors

TE Internal #: 1971845-3

PCB Mount Header, Vertical, Wire-to-Board, 3 Position, .197 in [5 mm] Centerline, Fully Shrouded, Tin, Through Hole - Solder, RAST 5 IDC Connectors

[View on TE.com >](#)



Connectors > PCB Connectors > PCB Headers & Receptacles

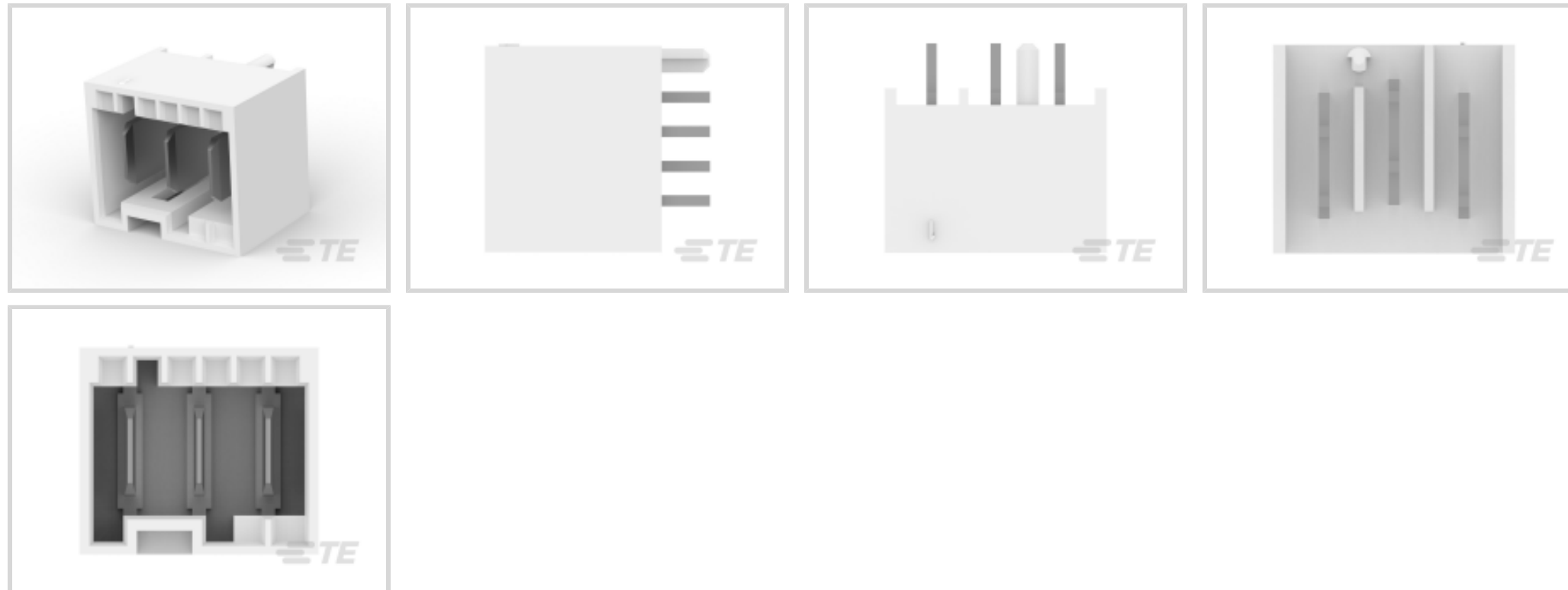

Connector System: **Wire-to-Board**

Number of Positions: **3**

Number of Rows: **1**

Centerline (Pitch): **5 mm [ .197 in ]**

PCB Mount Orientation: **Vertical**

## Features

### Product Type Features

Connector System	Wire-to-Board
Header Type	Fully Shrouded
Sealable	No
Connector & Contact Terminates To	Printed Circuit Board
PCB Connector Assembly Type	PCB Mount Header

### Configuration Features

Keying & Polarized Position Locations	1C, 2D
Number of Positions	3
Number of Rows	1
PCB Mount Orientation	Vertical

### Electrical Characteristics

Operating Voltage	250 VAC
-------------------	---------

### Body Features

Primary Product Color	Natural
-----------------------	---------



### Contact Features

PCB Contact Termination Area Plating Material Thickness	3.8 $\mu$ m[149.6 $\mu$ in]
Mating Tab Width	6.3 mm[.248 in]
Mating Tab Thickness	.8 mm[.032 in]
Contact Mating Area Plating Material Thickness	3.8 $\mu$ m[149.6 $\mu$ in]
PCB Contact Termination Area Plating Material Finish	Matte
Contact Shape & Form	Square
Contact Mating Area Plating Material Finish	Matte
PCB Contact Termination Area Plating Material	Tin
Contact Base Material	Copper Alloy
Contact Mating Area Plating Material	Tin
Contact Type	Tab
Contact Current Rating (Max)	16 A

### Termination Features

Square Termination Post & Tail Dimension	.8 mm[.032 in]
Termination Post & Tail Length	3.5 mm[.13 in]
Termination Method to Printed Circuit Board	Through Hole - Solder

### Mechanical Attachment

PCB Mount Alignment Type	Locating Posts
Mating Alignment Type	Keyed
Mating Retention	With
Mating Retention Type	Latch
Connector Mounting Type	Board Mount
Mating Alignment	With
PCB Mount Alignment	With
PCB Mount Retention	Without

### Housing Features

Housing Material	Nylon
Centerline (Pitch)	5 mm[.197 in]

### Dimensions

Connector Length	17.3 mm[.68 in]
Connector Height	12.8 mm[.5 in]



Row-to-Row Spacing	5 mm
--------------------	------

### Usage Conditions

Operating Temperature Range	-40 – 120 °C[-40 – 248 °F]
-----------------------------	----------------------------

### Operation/Application

Circuit Application	Power
---------------------	-------

### Industry Standards

UL Flammability Rating	UL 94V-0
------------------------	----------

### Packaging Features

Packaging Quantity	108
--------------------	-----

Packaging Type	Box, Tube
----------------	-----------

### Product Compliance

[For compliance documentation, visit the product page on TE.com>](#)

EU RoHS Directive 2011/65/EU	Compliant
------------------------------	-----------

EU ELV Directive 2000/53/EC	Compliant
-----------------------------	-----------

China RoHS 2 Directive MIIT Order No 32, 2016	No Restricted Materials Above Threshold
---	---

EU REACH Regulation (EC) No. 1907/2006	Current ECHA Candidate List: JUNE 2022 (224) Candidate List Declared Against: JAN 2022 (223) SVHC > Threshold: Not Yet Reviewed
--	--

Halogen Content	Not Low Halogen - contains Br or Cl > 900 ppm.
-----------------	--

Solder Process Capability	Not reviewed for solder process capability
---------------------------	--

#### Product Compliance Disclaimer

This information is provided based on reasonable inquiry of our suppliers and represents our current actual knowledge based on the information they provided. This information is subject to change. The part numbers that TE has identified as EU RoHS compliant have a maximum concentration of 0.1% by weight in homogenous materials for lead, hexavalent chromium, mercury, PBB, PBDE, DBP, BBP, DEHP, DIBP, and 0.01% for cadmium, or qualify for an exemption to these limits as defined in the Annexes of Directive 2011/65/EU (RoHS2). Finished electrical and electronic equipment products will be CE marked as required by Directive 2011/65/EU. Components may not be CE marked. Additionally, the part numbers that TE has identified as EU ELV compliant have a maximum concentration of 0.1% by weight in homogenous materials for lead, hexavalent chromium, and mercury, and 0.01% for cadmium, or qualify for an exemption to these limits as defined in the Annexes of Directive 2000/53/EC (ELV). Regarding the REACH Regulation, the information TE provides on SVHC in articles for this part number is based on the latest European Chemicals Agency (ECHA) 'Guidance on requirements for substances in articles' posted at this URL: <https://echa.europa.eu/guidance-documents/guidance-on-reach>

## Compatible Parts

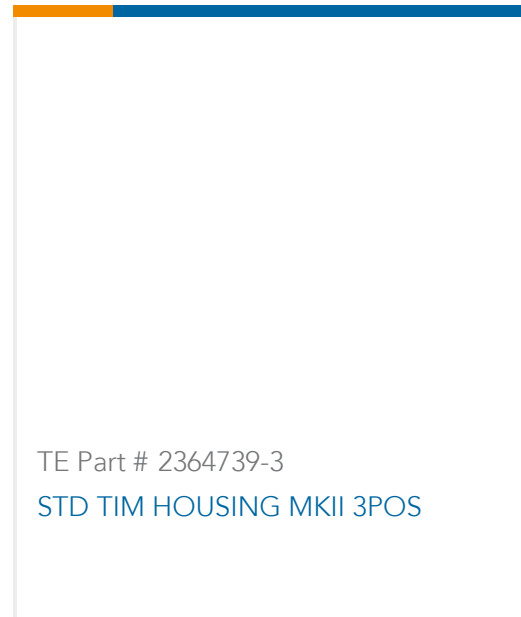
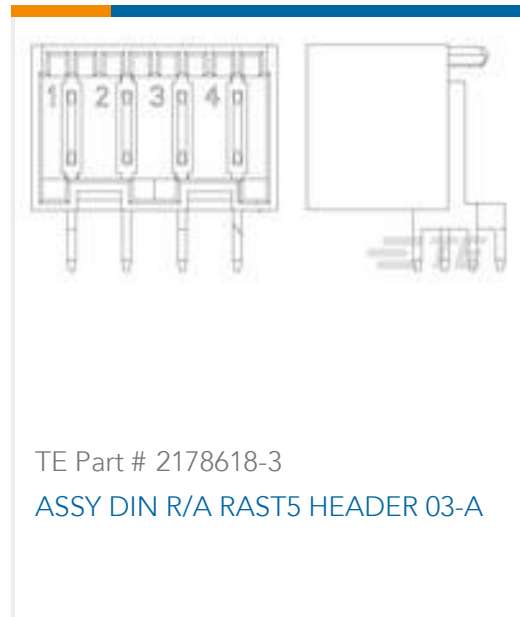

## Also in the Series | RAST 5 IDC Connectors

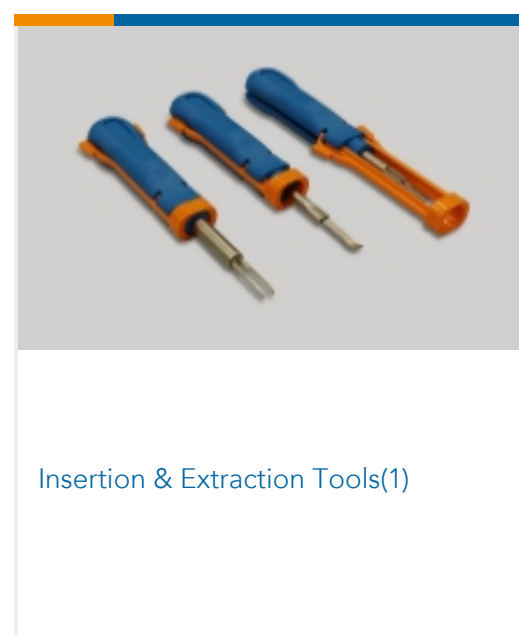
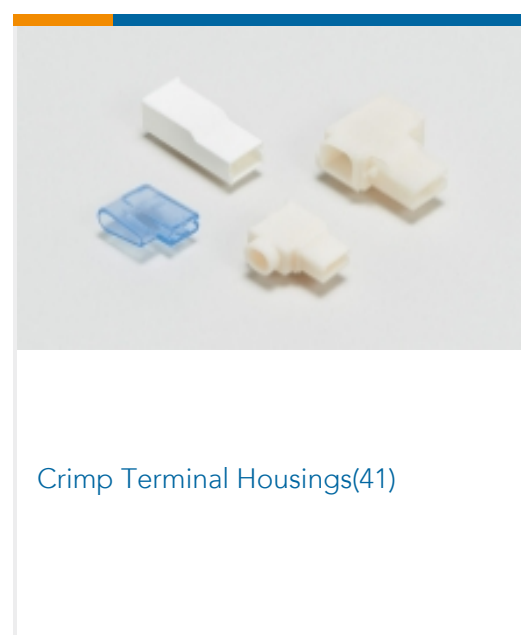
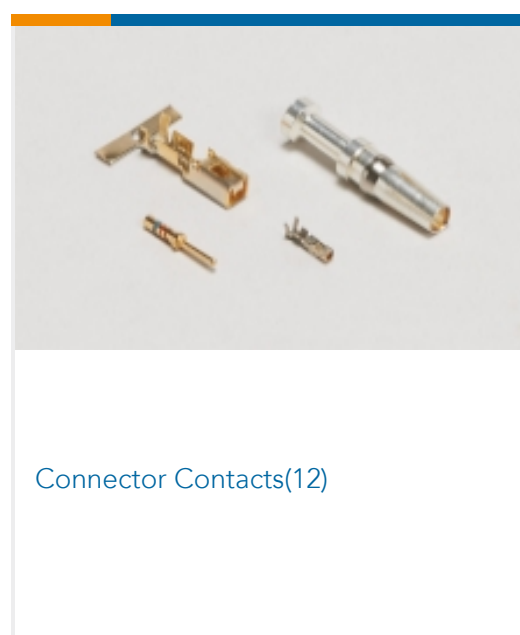
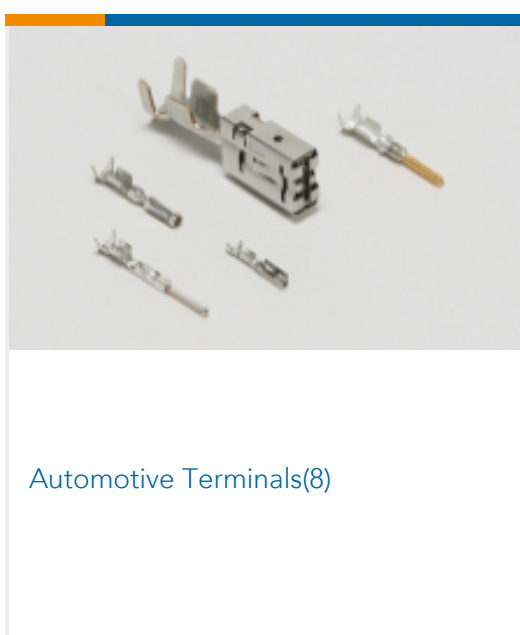



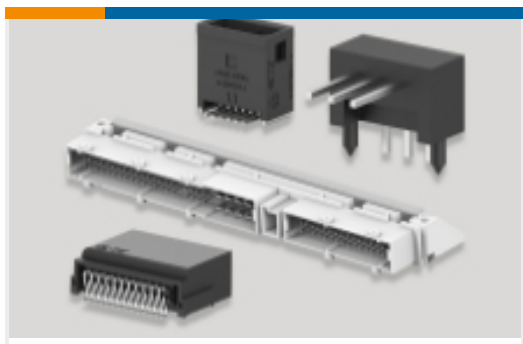

PCB Headers & Receptacles(424)



Rectangular Connector Housings(1)

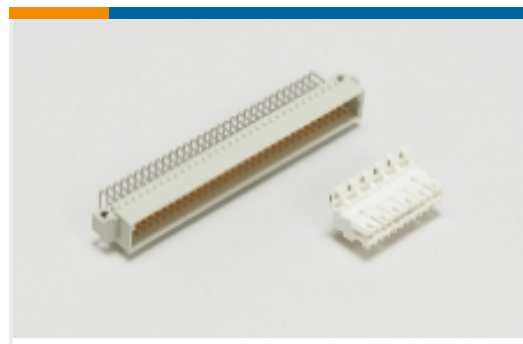

Standard Edge Connectors(47)

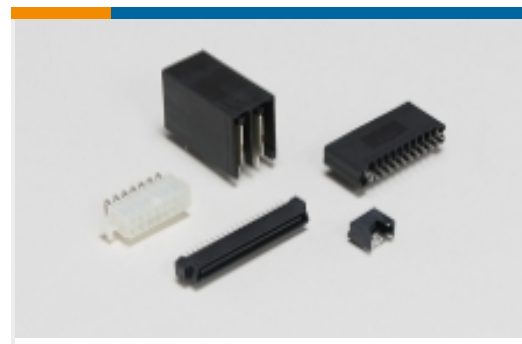

Standard Rectangular Connectors(112)



Wire-to-Board Connector Assemblies & Housings(213)



Wire-to-Board Connector Contacts(2)

## Customers Also Bought



TE Part #440055-6  
2.0MM,HDR,6POS,R/A

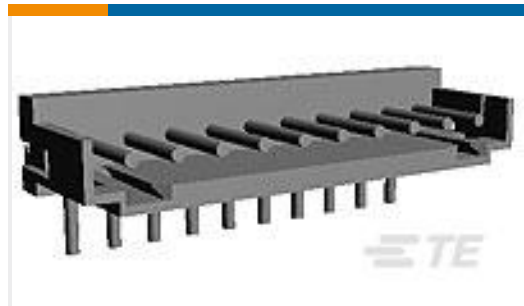

TE Part #1-292253-1  
CT CONN MT HDR ASSY H 11P NAT



TE Part #1734099-4  
Champ 050 series,plug assembly



TE Part #5053394020  
RNF-100-2-0-SP

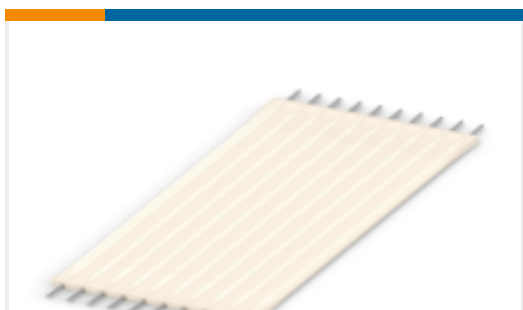

TE Part #5-6437137-0  
FSN-21.5A-20



TE Part #5-1971846-2  
2P, RAST 5 Tab Header, THV



TE Part #1649329-7  
RTE24048



TE Part #4-1971846-2  
2P, RAST 5 Tab Header, THV

## Documents

### Product Drawings

[3P, RAST 5 Tab Header, THV](#)

English

### CAD Files

[3D PDF](#)

[3D](#)

[Customer View Model](#)

[ENG\\_CVM\\_CVM\\_1971845-3\\_B\\_c-1971845-3-b.2d\\_dxf.zip](#)



English

**Customer View Model**

[ENG\\_CVM\\_CVM\\_1971845-3\\_B\\_c-1971845-3-b.3d\\_igs.zip](#)

English

**Customer View Model**

[ENG\\_CVM\\_CVM\\_1971845-3\\_B\\_c-1971845-3-b.3d\\_stp.zip](#)

English

By downloading the CAD file I accept and agree to the [Terms and Conditions](#) of use.

---

**Datasheets & Catalog Pages**

[7-1773465-5 RAST5.0 Flyer](#)

English

---

**Product Specifications**

[Product Specification](#)

English

---

**Product Environmental Compliance**

[MD\\_1971845-3\\_06192017312\\_dmtec](#)

English

[MD\\_1971845-3\\_06192017312\\_dmtec](#)

English

---

**Agency Approvals**

[VDE Certificate](#)

English