

2-172076-2 ✓ ACTIVE

[Positive Lock](#) | [Positive Lock 250](#)

TE Internal #: 2-172076-2

Crimp Terminal Housings, Receptacle, Receptacle, 1 Position,
Straight, UL 94V-0, Black, Nylon, Contact Mating Retention, Positive
Lock 250

[View on TE.com >](#)



Terminals & Splices > Terminal Housings, Insulation Sleeves & Blocks > Crimp Terminal Housings



Terminal Type: **Receptacle**

Housing Type: **Receptacle**

Number of Positions: **1**

Terminal Orientation: **Straight**

UL Flammability Rating: **UL 94V-0**

Features

Product Type Features

Terminates To	Wire & Cable
Product Type	Terminal Housing
Sealable	No
Connector System	Wire-to-Board, Wire-to-Wire
Housing Type	Receptacle
Insulated	No

Configuration Features

Number of Positions	1
---------------------	---

Body Features

Primary Product Color	Black
-----------------------	-------

Contact Features

Terminal Type	Receptacle
Terminal Orientation	Straight
Contact Mating Retention	With



Mechanical Attachment

Mating Alignment Type	Polarization
Mating Alignment	With
Crimp Terminal Housing Mounting Style	Cable Mount (Free-Hanging)

Housing Features

Housing Material	Nylon
------------------	-------

Usage Conditions

Operating Temperature Range	-40 – 105 °C[-40 – 221 °F]
-----------------------------	----------------------------

Industry Standards

UL Flammability Rating	UL 94V-0
------------------------	----------

Packaging Features

Packaging Quantity	1000
--------------------	------

Product Compliance

[For compliance documentation, visit the product page on TE.com>](#)

EU RoHS Directive 2011/65/EU	Compliant
EU ELV Directive 2000/53/EC	Compliant
China RoHS 2 Directive MIIT Order No 32, 2016	No Restricted Materials Above Threshold
EU REACH Regulation (EC) No. 1907/2006	Current ECHA Candidate List: JUNE 2022 (224) Candidate List Declared Against: JAN 2022 (223) SVHC > Threshold: Not Yet Reviewed
Halogen Content	Low Halogen - Br, Cl, F, I < 900 ppm per homogenous material. Also BFR/CFR/PVC Free
Solder Process Capability	Not applicable for solder process capability

Product Compliance Disclaimer

This information is provided based on reasonable inquiry of our suppliers and represents our current actual knowledge based on the information they provided. This information is subject to change. The part numbers that TE has identified as EU RoHS compliant have a maximum concentration of 0.1% by weight in homogenous materials for lead, hexavalent chromium, mercury, PBB, PBDE, DBP, BBP, DEHP, DIBP, and 0.01% for cadmium, or qualify for an exemption to these limits as defined in the Annexes of Directive 2011/65/EU (RoHS2). Finished electrical and electronic equipment products will be CE marked as required by Directive 2011/65/EU. Components may not be CE marked. Additionally, the part numbers that TE has identified as EU ELV compliant have a maximum concentration of 0.1% by weight in homogenous materials for lead, hexavalent chromium, and mercury, and 0.01% for cadmium, or qualify for an exemption to these limits as defined in the Annexes of Directive 2000/53/EC (ELV). Regarding the REACH Regulation, the information TE provides on SVHC in articles for this part number is based on the latest European Chemicals Agency (ECHA) 'Guidance on

requirements for substances in articles' posted at this URL: <https://echa.europa.eu/guidance-documents/guidance-on-reach>

Compatible Parts



TE Part # 170329-1
250 PL MKII REC. 15-10AWG PTBR



TE Part # 170328-1
250 PL MKII REC. 18-14AWG PTBR



TE Part # 724659-2
EXT TOOL FOR POSITIVE .250



TE Part # 170333-1
PL 250 RECEPTACLE 22-18 AWG
PTPBR



TE Part # 170335-1
PL 250 RECEPTACLE 15-10 AWG
PTPBR



TE Part # 170327-1
250 PL MKII REC. 22-18AWG PTBR



TE Part # 170334-1
205 PL MII,REC.,18-14,PTBR



TE Part # 3-172076-1
POSITIVE LOCK 250 HOUSING
RECEPTACLE

Also in the Series | Positive Lock 250

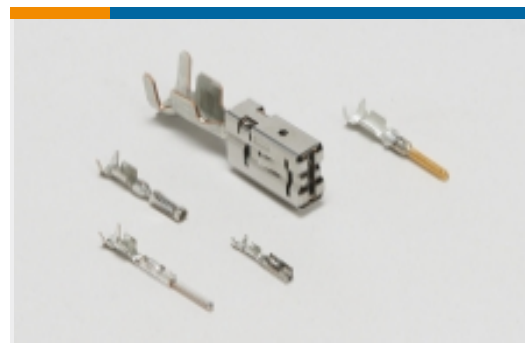

Automotive Terminals(1)



Crimp Terminal Housings(203)



Insertion & Extraction Tools(3)



Insulation Boots & Sleeves(4)

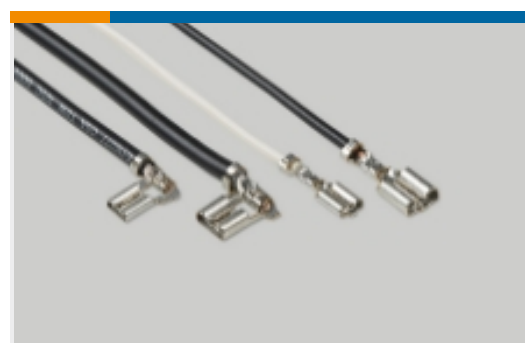

Quick Disconnects(189)

Customers Also Bought

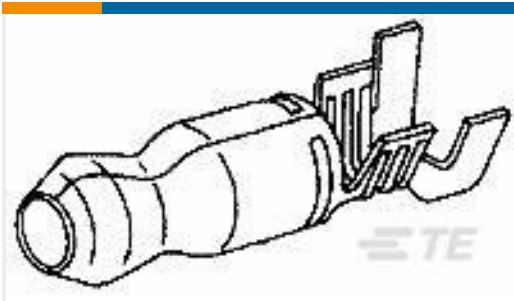

TE Part #60793-1
SHUR PLUG .180 18-14 AWG TPBR

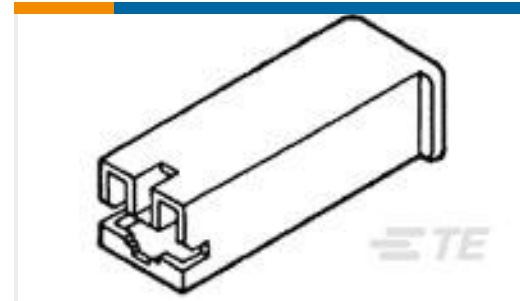

TE Part #2-172076-1
250 HSG. PL MKII REC. NAT

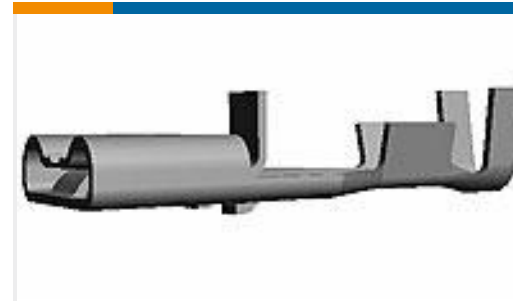

TE Part #170328-1
250 PL MKII REC. 18-14AWG PTBR



TE Part #770052-1
06P UMNL II CAP REAR 94VO



TE Part #1721870-5
OJE-SH-112LMHF,000



TE Part #5-177912-1
POWER D/LOCK CAP HSG 10P NAT
(GWT)

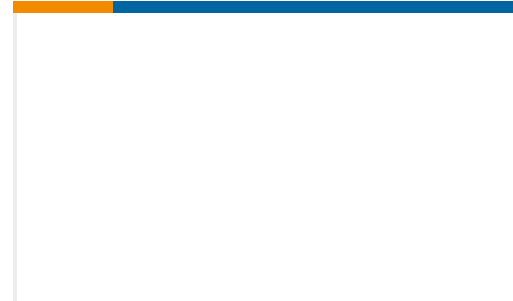

TE Part #2071266-4
EF00-1A2-D012-F



TE Part #1721142-6
PCJ-112D3M,0002M

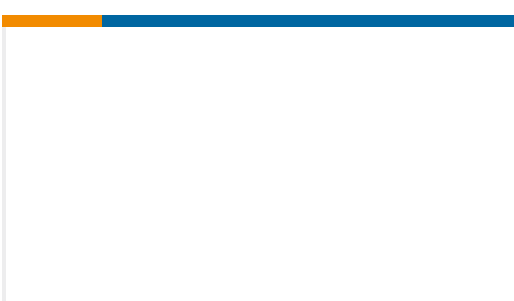

TE Part #2071369-3
OJE-SH-112DM,00E3W

Documents

Product Drawings

POSITIVE LOCK 250 HOUSING RECEPTACLE

English

CAD Files

3D PDF

3D

Customer View Model

[ENG_CVM_CVM_2-172076-2_W.2d_dxf.zip](#)

English

Customer View Model

[ENG_CVM_CVM_2-172076-2_W.3d_igs.zip](#)

English

Customer View Model

[ENG_CVM_CVM_2-172076-2_W.3d_stp.zip](#)

English

By downloading the CAD file I accept and agree to the [Terms and Conditions](#) of use.

Datasheets & Catalog Pages



Positive Lock Receptacles

English

Product Specifications

Application Specification

English

Application Specification

Japanese

CRIMP OF MATE-N-LOK PIN CONTACT

Japanese

CRIMP OF MATE-N-LOK PIN CONTACT

English

Application Specification

English

Product Environmental Compliance

Product Compliance

English

Product Compliance

English

Agency Approvals

Agency Approval Document

English