

2-320552-1 ✓ ACTIVE



PIDG

TE Internal #: 2-320552-1

Ring Terminals & Spade Terminals, Ring Tongue, 22 – 16 AWG

Wire Size, .3 – 1.42 mm² Wire Size, 509 – 3260 CMA Wire Size, Stud

Size #10

[View on TE.com >](#)

Terminals & Splices > Ring Terminals & Spade Terminals > PIDG RING TONGUE TERMINALS

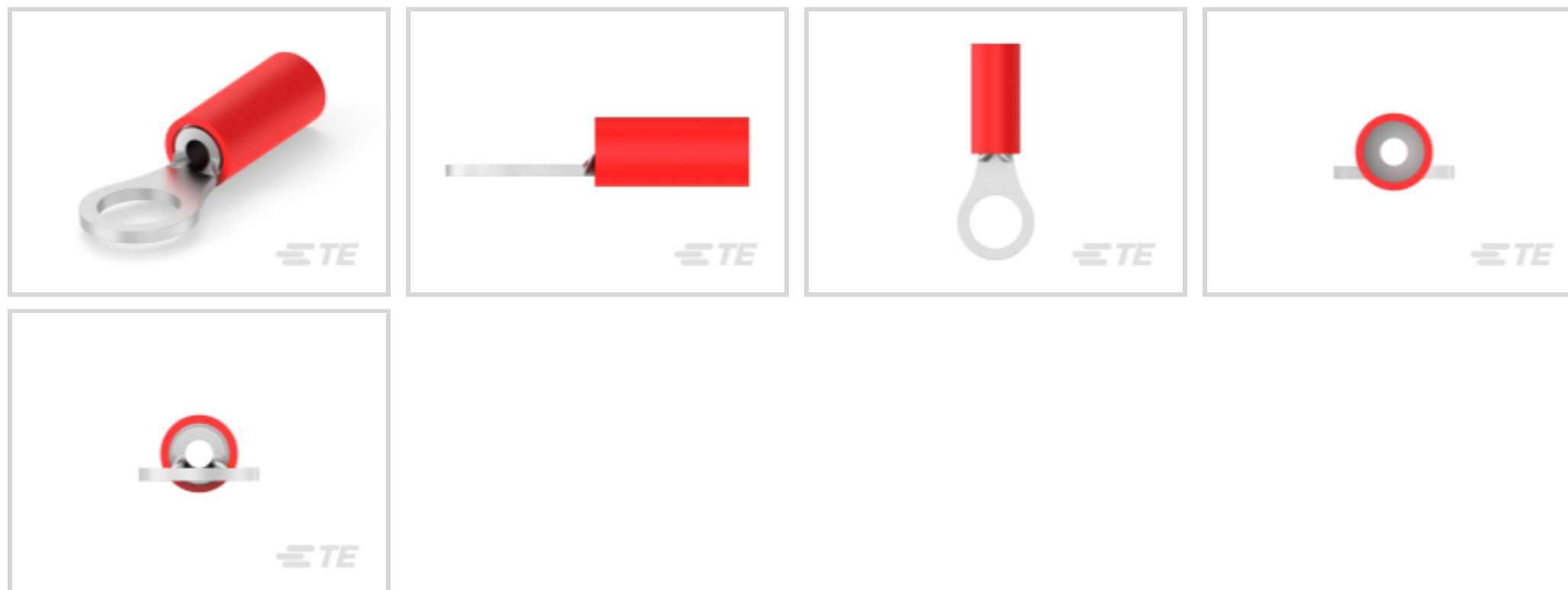

Ring & Spade Terminal Type: **Ring Tongue**

Wire Size: **509 – 3260 CMA**

Stud Size: **#10**

[All PIDG RING TONGUE TERMINALS \(421\)](#)

Features

Product Type Features

Shape Description	RING-041
Stud Size	#10
Sealable	No
Wire Insulation Support Retention Type	Insulation Support

Configuration Features

Number of Holes	1
Terminal Angle	180 °

Electrical Characteristics

Voltage (Max)	300 V
---------------	-------

Body Features

Weight per Piece	.877 g
------------------	--------

Contact Features

Ring & Spade Terminal Type	Ring Tongue
----------------------------	-------------



Barrel Type	Closed
-------------	--------

Terminal Orientation	Offset
----------------------	--------

Terminal Plating Material	Tin
---------------------------	-----

Mechanical Attachment

Wire Insulation Support	With
-------------------------	------

Dimensions

Wire Size	509 – 3260 CMA
-----------	----------------

Stud Diameter	5 mm [.197 in]
---------------	----------------

Tongue Thickness	.79 mm [.031 in]
------------------	------------------

Overall Product Length	20.24 mm [.797 in]
------------------------	--------------------

Accepts Wire Insulation Diameter (Max)	3.18 mm [.125 in]
--	-------------------

Accepts Wire Insulation Diameter Range	2.03 – 3.18 mm [.08 – .125 in]
--	--------------------------------

Usage Conditions

Insulation Option	Partially Insulated
-------------------	---------------------

Operating Temperature Range	105 °C [221 °F]
-----------------------------	-----------------

Operation/Application

Compatible With Wire Base Material	Copper
------------------------------------	--------

Compatible With Wire Plating Material	Tin
---------------------------------------	-----

Heavy Duty	No
------------	----

Industry Standards

Government Qualified	No
----------------------	----

Packaging Features

Packaging Quantity	5000
--------------------	------

Packaging Method	Tape Mounted
------------------	--------------

Product Compliance

[For compliance documentation, visit the product page on TE.com>](#)

EU RoHS Directive 2011/65/EU	Compliant
------------------------------	-----------

EU ELV Directive 2000/53/EC	Compliant
-----------------------------	-----------

China RoHS 2 Directive MIIT Order No 32, 2016	No Restricted Materials Above Threshold
---	---

EU REACH Regulation (EC) No. 1907/2006	Current ECHA Candidate List: JUNE 2022 (224)
--	--

Candidate List Declared Against: JAN 2022
(223)
SVHC > Threshold:
Not Yet Reviewed

Halogen Content

Low Halogen - Br, Cl, F, I < 900 ppm per homogenous material. Also BFR/CFR/PVC Free

Solder Process Capability

Not applicable for solder process capability

Product Compliance Disclaimer

This information is provided based on reasonable inquiry of our suppliers and represents our current actual knowledge based on the information they provided. This information is subject to change. The part numbers that TE has identified as EU RoHS compliant have a maximum concentration of 0.1% by weight in homogenous materials for lead, hexavalent chromium, mercury, PBB, PBDE, DBP, BBP, DEHP, DIBP, and 0.01% for cadmium, or qualify for an exemption to these limits as defined in the Annexes of Directive 2011/65/EU (RoHS2). Finished electrical and electronic equipment products will be CE marked as required by Directive 2011/65/EU. Components may not be CE marked. Additionally, the part numbers that TE has identified as EU ELV compliant have a maximum concentration of 0.1% by weight in homogenous materials for lead, hexavalent chromium, and mercury, and 0.01% for cadmium, or qualify for an exemption to these limits as defined in the Annexes of Directive 2000/53/EC (ELV). Regarding the REACH Regulation, the information TE provides on SVHC in articles for this part number is based on the latest European Chemicals Agency (ECHA) 'Guidance on requirements for substances in articles' posted at this URL: <https://echa.europa.eu/guidance-documents/guidance-on-reach>

Compatible Parts



REPRESENTATION ONLY

TE Part # 47386
DAHT PG PIDG 26-16 ASSY



TE Part # 58433-3
PRO CR ASSY, RBY IS9252



TE Part # 58423-1
DIE, RBY IS9252



TE Part # 169404
CERTI-LOK DIE

Also in the Series | PIDG



Compression Connectors(17)



Crimp Terminal Housings(1)



Crimp Wire Pins, Tabs & Ferrules(41)



Knife Disconnects(11)



PCB Terminals(9)



Portable Crimp Tools(2)

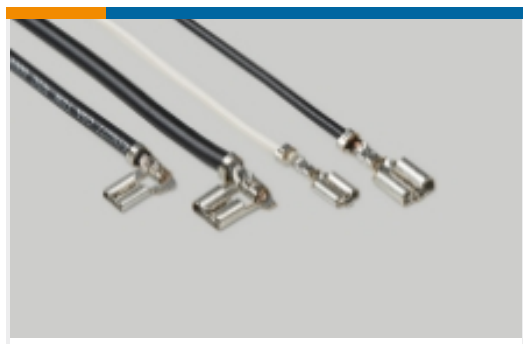

Quick Disconnects(53)



Ring Terminals & Spade Terminals(861)



Special Purpose Terminals(1)



Splices(48)

Customers Also Bought

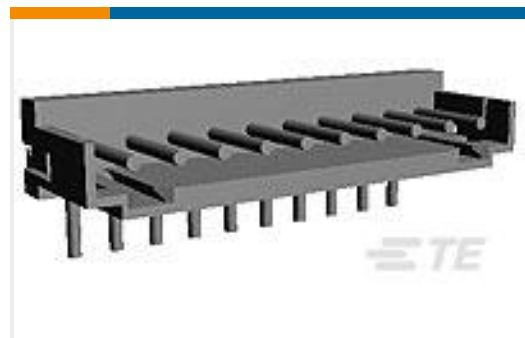

TE Part #292253-9
CT CONN MT HDR ASSY H 9P NAT



TE Part #1775470-8
HPI CONN., 2.0MM, V/T, SMT, 8P, 80U"



TE Part #2-326861-1
TERMINAL,PIDG SPD 22-16 6



TE Part #7-520365-2
ULTRA-FAST .110/.125 ASY REC 26-22 TPBR



TE Part #6609108-6
PEOS0SZXC M0=C7046



TE Part #52936-1
TERMINAL,PIDG SPR SPD 16-14 8



TE Part #4-292254-2
CT RELAY HDR ASSY 2P YELLOW

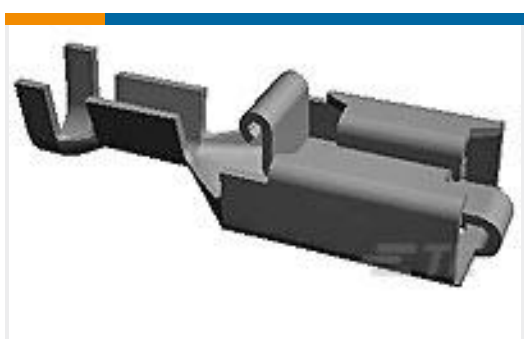

TE Part #928958-8
PL REC 2.5-4.0 MM2 0.40 X 52.32 SP



TE Part #2202502-2
C/A, 4X MINISAS HD, 28AWG PASSIVE, 1M

Documents



Product Drawings

[PIDG R 22-16 COMM 22-18 MIL 10](#)

English

CAD Files

[3D PDF](#)

3D

Customer View Model

[ENG_CVM_CVM_2-320552-1_T.2d_dxf.zip](#)

English

Customer View Model

[ENG_CVM_CVM_2-320552-1_T.3d_igs.zip](#)

English

Customer View Model

[ENG_CVM_CVM_2-320552-1_T.3d_stp.zip](#)

English

Customer View Model

[ENG_CVM_2-320552-1_H.3d_igs.zip](#)

English

Customer View Model

[ENG_CVM_2-320552-1_H.3d_stp.zip](#)

English

Customer View Model

[ENG_CVM_2-320552-1_H.2d_dxf.zip](#)

English

[3D PDF](#)

English

By downloading the CAD file I accept and agree to the [Terms and Conditions](#) of use.

Product Specifications

[Application Specification](#)

English

Product Environmental Compliance

[MD_2-320552-1_04282016242_dmtec](#)

English

[MD_2-320552-1_04282016242_dmtec](#)

English

Agency Approvals

[UL Report](#)

English

[UL Report](#)

English