

2-1969540-0 ✓ ACTIVE

Economy Power 2.5

TE Internal #: 2-1969540-0

Housing, Plug, Wire-to-Wire, 20 Position, 2.5 mm [.098 in]
Centerline, Crimp, 2 Row, White, Mating Retention, Wire & Cable,
Economy Power 2.5

[View on TE.com >](#)



Connectors > PCB Connectors > Wire-to-Board Connectors > Wire-to-Board Connector Assemblies & Housings

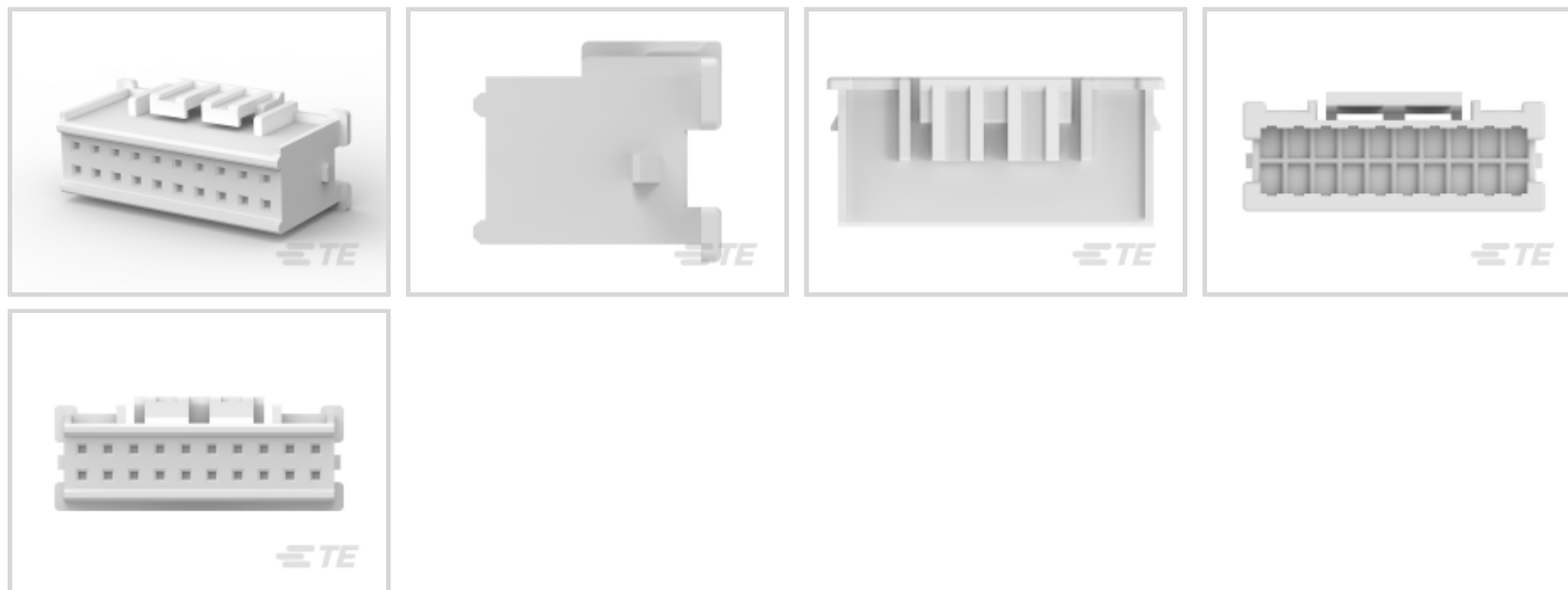

Connector Product Type: **Housing**

Connector & Housing Type: **Plug**

Connector System: **Wire-to-Wire**

Number of Positions: **20**

Centerline (Pitch): **2.5 mm [.098 in]**

Features

Product Type Features

Connector Product Type	Housing
Connector & Housing Type	Plug
Connector System	Wire-to-Wire
Sealable	No
Connector & Contact Terminates To	Wire & Cable

Configuration Features

Number of Positions	20
Number of Rows	2

Electrical Characteristics

Operating Voltage	250 VAC
-------------------	---------

Contact Features

Contact Type	Socket
--------------	--------

Termination Features

--	--



Termination Method to Wire & Cable	Crimp
------------------------------------	-------

Mechanical Attachment

Strain Relief	Without
---------------	---------

Panel Mount Feature	Without
---------------------	---------

PCB Mount Retention	Without
---------------------	---------

Mating Retention Type	Latch
-----------------------	-------

Mating Retention	With
------------------	------

Connector Mounting Type	Cable Mount (Free-Hanging)
-------------------------	----------------------------

Housing Features

Housing Entry Configuration	Both Ends Closed
-----------------------------	------------------

Housing Material	Nylon - GF
------------------	------------

Centerline (Pitch)	2.5 mm [.098 in]
--------------------	------------------

Housing Color	White
---------------	-------

Dimensions

Connector Length	26.04 mm [1.02 in]
------------------	--------------------

Connector Height	8.3 mm [.326 in]
------------------	------------------

Wire Size	.13 – .33 mm ²
-----------	---------------------------

Row-to-Row Spacing	2.5 mm [.09 in]
--------------------	-----------------

Usage Conditions

Operating Temperature Range	-55 – 105 °C [-67 – 221 °F]
-----------------------------	-----------------------------

Operation/Application

Circuit Application	Power & Signal
---------------------	----------------

Industry Standards

Glow Wire Rating	Standard Part - Not Glow Wire
------------------	-------------------------------

UL Flammability Rating	UL 94V-0
------------------------	----------

Packaging Features

Packaging Quantity	1200
--------------------	------

Packaging Method	Bag
------------------	-----

Product Compliance

For compliance documentation, visit the product page on [TE.com](https://www.te.com)>

EU RoHS Directive 2011/65/EU	Compliant
------------------------------	-----------



EU ELV Directive 2000/53/EC	Compliant
China RoHS 2 Directive MIIT Order No 32, 2016	No Restricted Materials Above Threshold
EU REACH Regulation (EC) No. 1907/2006	Current ECHA Candidate List: JUNE 2022 (224) Candidate List Declared Against: JAN 2022 (223) SVHC > Threshold: Not Yet Reviewed
Halogen Content	Low Halogen - Br, Cl, F, I < 900 ppm per homogenous material. Also BFR/CFR/PVC Free
Solder Process Capability	Not applicable for solder process capability

Product Compliance Disclaimer

This information is provided based on reasonable inquiry of our suppliers and represents our current actual knowledge based on the information they provided. This information is subject to change. The part numbers that TE has identified as EU RoHS compliant have a maximum concentration of 0.1% by weight in homogenous materials for lead, hexavalent chromium, mercury, PBB, PBDE, DBP, BBP, DEHP, DIBP, and 0.01% for cadmium, or qualify for an exemption to these limits as defined in the Annexes of Directive 2011/65/EU (RoHS2). Finished electrical and electronic equipment products will be CE marked as required by Directive 2011/65/EU. Components may not be CE marked. Additionally, the part numbers that TE has identified as EU ELV compliant have a maximum concentration of 0.1% by weight in homogenous materials for lead, hexavalent chromium, and mercury, and 0.01% for cadmium, or qualify for an exemption to these limits as defined in the Annexes of Directive 2000/53/EC (ELV). Regarding the REACH Regulation, the information TE provides on SVHC in articles for this part number is based on the latest European Chemicals Agency (ECHA) 'Guidance on requirements for substances in articles' posted at this URL: <https://echa.europa.eu/guidance-documents/guidance-on-reach>

Compatible Parts



TE Part # 1-1969540-6
HOUSING, PLUG, 16P,DUAL ROW,
EP2.5



TE Part # 1969540-8
HOUSING, PLUG, 8P, DUAL ROW,
EP2.5



TE Part # 1-1969540-2
HOUSING, PLUG, 12P, DUAL ROW,
EP2.5



TE Part # 1-1969540-0
HOUSING, PLUG, 10P,DUAL ROW,
EP2.5



TE Part # 2-2324579-0
HOUSING, PLUG, 20P,DUAL ROW,
EP2.5



TE Part # 1-1969540-4
HOUSING, PLUG, 14P,DUAL ROW,
EP2.5



TE Part # 1-1969540-8
HOUSING, PLUG, 18P,DUAL ROW,
EP2.5

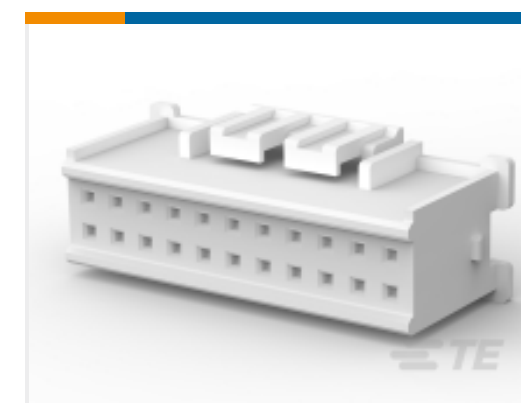

TE Part # 2-1969540-2
HOUSING, PLUG, 22P,DUAL ROW,
EP2.5



Also in the Series | Economy Power 2.5

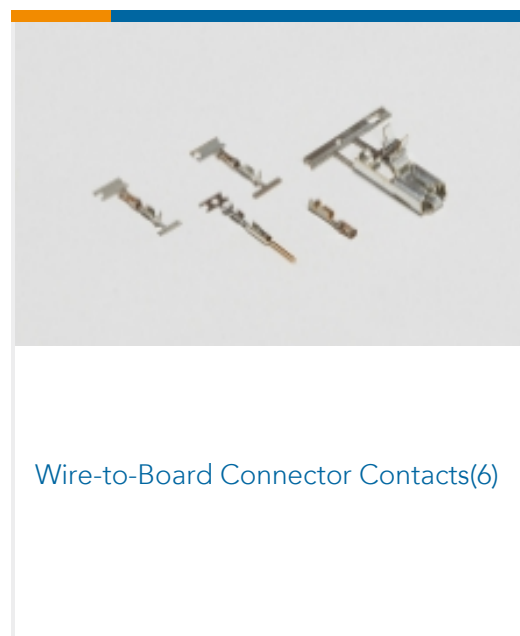
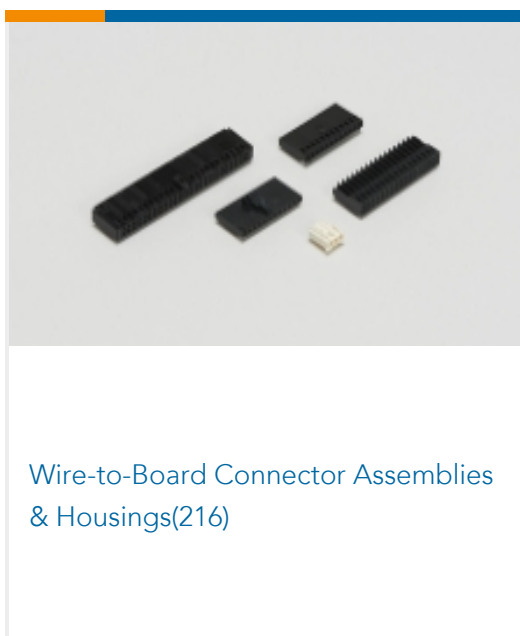
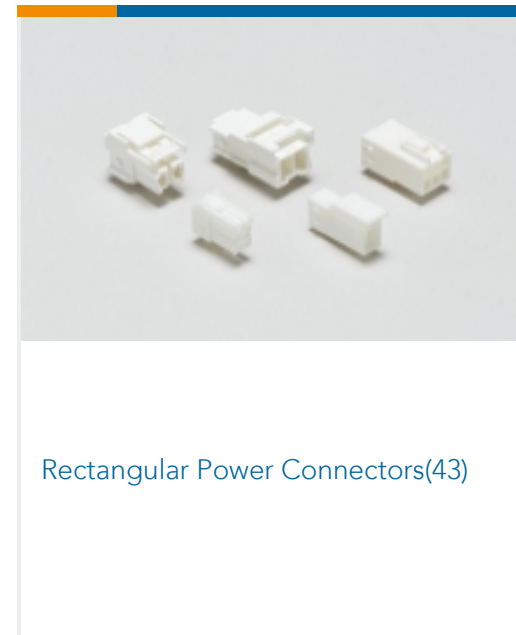
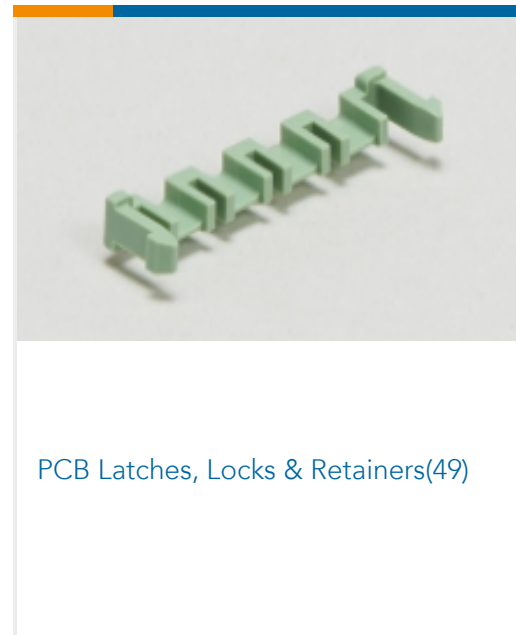
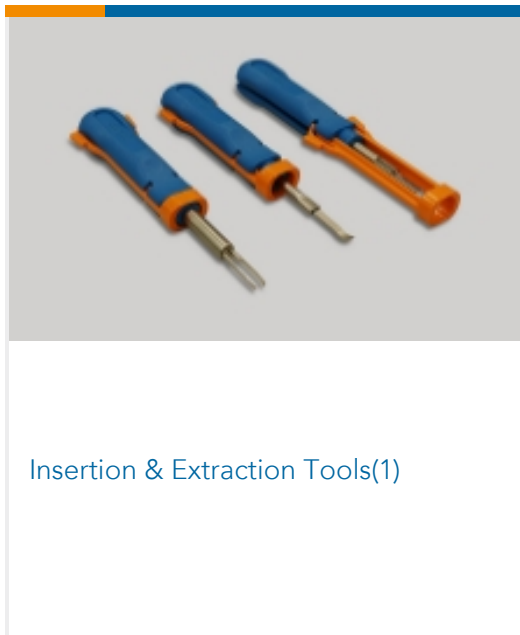

Customers Also Bought

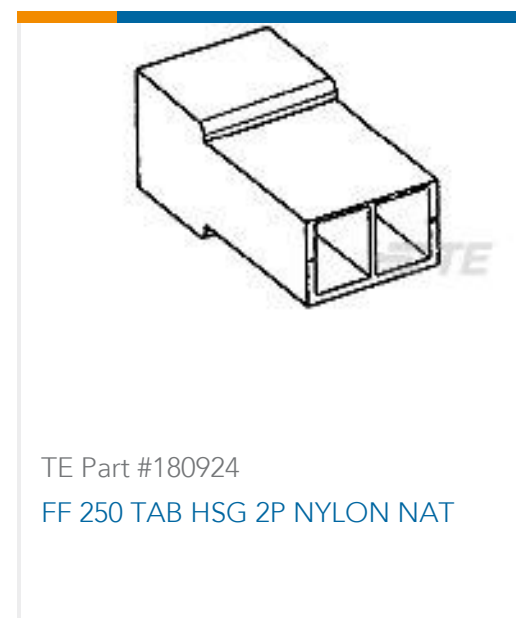

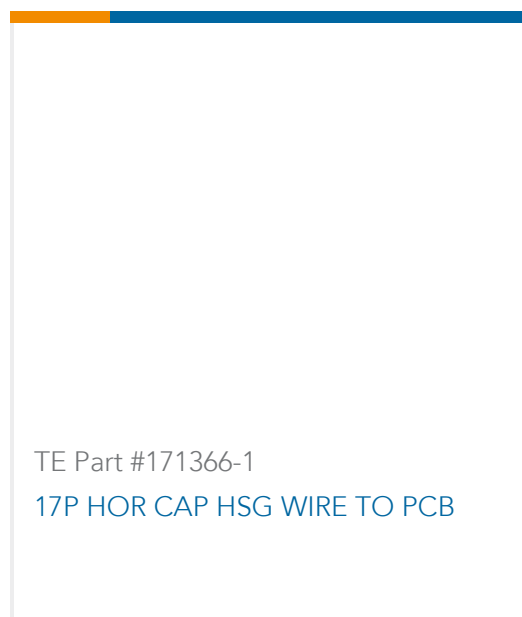

Documents

Product Drawings

[HOUSING, PLUG, 20P,DUAL ROW, EP2.5](#)

English

CAD Files

[3D PDF](#)

3D

Customer View Model

[ENG_CVM_CVM_2-1969540-0_A_c-2-1969540-0-a.2d_dxf.zip](#)

English

Customer View Model

[ENG_CVM_CVM_2-1969540-0_A_c-2-1969540-0-a.3d_igs.zip](#)

English

Customer View Model

[ENG_CVM_CVM_2-1969540-0_A_c-2-1969540-0-a.3d_stp.zip](#)

English

By downloading the CAD file I accept and agree to the [Terms and Conditions](#) of use.

Datasheets & Catalog Pages

[7-1773461-6_EP2.5_Connector_Series](#)

English

Product Specifications

[Application Specification](#)

English

Instruction Sheets

[Instruction Sheet \(U.S.\)](#)

English

Agency Approvals

[VDE Certificate](#)

English