



Connectors > Power Connectors > Circular Power > Circular Power Connectors > CPC SERIES 2



Connector Product Type: **Housing**

Operating Voltage: **250 VDC**

Connector System: **Wire-to-Wire**

Number of Positions: **28**

Sealable: **No**

[All CPC SERIES 2 \(24\)](#)

Features

Product Type Features

Connector Product Type	Housing
Connector System	Wire-to-Wire
Sealable	No
Connector & Contact Terminates To	Wire & Cable
Connector & Housing Type	Plug
Circular Connector Shell Type	All Plastic

Configuration Features

Reverse Numbering	Without
Number of Positions	28
Number of Power Positions	0
Number of Signal Positions	28

Electrical Characteristics



Operating Voltage	250 VAC
-------------------	---------

Contact Features

Reverse Gender	Yes
Contact Type	Pin
Contact Current Rating (Max)	7.5 A
Contact Protection	With

Mechanical Attachment

Panel Mount Feature Type	Flange
Screw & Hole Thread Size	15/16-20 UNEF – 2A
Connector Mounting Type	Cable Mount (Free-Hanging)
Mating Alignment	With
Mating Retention	With
Panel Mount Feature	Without
Mating Alignment Type	Keyed
Mating Retention Type	Threaded Coupling

Housing Features

Body Orientation	Straight
Housing Color	Black
Housing Material	Polyester, Thermoplastic
Circular Connector Shell Size	17

Dimensions

Accepts Wire Insulation Diameter Range	1.73 mm [.068 in]
--	-------------------

Usage Conditions

Operating Temperature Range	-55 – 105 °C [-67 – 221 °F]
Fluid Resistance	None

Operation/Application

Circuit Application	Signal
Shielded	No

Industry Standards

UL Flammability Rating	UL 94V-0
VDE Tested	No

Packaging Features



Packaging Method	Bag
Packaging Quantity	100

Product Compliance

[For compliance documentation, visit the product page on TE.com>](#)

EU RoHS Directive 2011/65/EU	Compliant
EU ELV Directive 2000/53/EC	Compliant
China RoHS 2 Directive MIIT Order No 32, 2016	No Restricted Materials Above Threshold
EU REACH Regulation (EC) No. 1907/2006	Current ECHA Candidate List: JUNE 2022 (224) Candidate List Declared Against: JAN 2022 (223) SVHC > Threshold: Not Yet Reviewed
Halogen Content	Not Low Halogen - contains Br or Cl > 900 ppm.
Solder Process Capability	Not applicable for solder process capability

Product Compliance Disclaimer

This information is provided based on reasonable inquiry of our suppliers and represents our current actual knowledge based on the information they provided. This information is subject to change. The part numbers that TE has identified as EU RoHS compliant have a maximum concentration of 0.1% by weight in homogenous materials for lead, hexavalent chromium, mercury, PBB, PBDE, DBP, BBP, DEHP, DIBP, and 0.01% for cadmium, or qualify for an exemption to these limits as defined in the Annexes of Directive 2011/65/EU (RoHS2). Finished electrical and electronic equipment products will be CE marked as required by Directive 2011/65/EU. Components may not be CE marked. Additionally, the part numbers that TE has identified as EU ELV compliant have a maximum concentration of 0.1% by weight in homogenous materials for lead, hexavalent chromium, and mercury, and 0.01% for cadmium, or qualify for an exemption to these limits as defined in the Annexes of Directive 2000/53/EC (ELV). Regarding the REACH Regulation, the information TE provides on SVHC in articles for this part number is based on the latest European Chemicals Agency (ECHA) 'Guidance on requirements for substances in articles' posted at this URL: <https://echa.europa.eu/guidance-documents/guidance-on-reach>

Compatible Parts

TE Part # CAT-AM71-C83998M
CPC SERIES 2

TE Part # 207299-3
FLANGE PLUG MOUNT CPC

TE Part # CAT-AM71-C83998
HEAT SHRINK STRAIN RELIEFS-CPC

TE Part # CAT-035-DCCSC20
D-Sub Conn Contacts: Socket, Phosphor Bronze, Signal, Size 20

TE Part # CAT-035-DCCPB20
D-Sub Connector Contacts: Pin, Brass, Signal, Size 20



TE Part # CAT-AM71-C83998B
CPC CABLE CLAMPS



TE Part # 213810-1
CPC COUPLING RING SIZE 17



TE Part # 91503-1
CCII AMPLIMITE 20 DF PIN SKT 28-20 ASSY



TE Part # 205089-1
HD 20 PIN CONTACT



TE Part # 205090-1
HD 20 SOCKET CONTACT



TE Part # 207241-1
CABLE BOOT, SZ 17, CPC



TE Part # 207387-1
CABLE GRIP, SZ 17, CPC



TE Part # 208652-1
SEALING CAP ASSY, SZ 17, CPC



TE Part # 206509-1
SIZE 20 KEYING PLUG



TE Part # CAT-AM71-C83998DD
CPC SERIES 2 POSTED

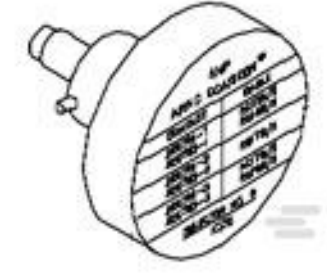

TE Part # 601966-5
K13-1 POSITIONER



TE Part # 601966-1
CRIMPING TOOL M22520/2-01



TE Part # 205089-2
PIN CONTACT, SZ 20, AMPLIMITE



TE Part # 205090-2
SKT CONT ASSY, SZ 20, AMPLIMITE



TE Part # 207216-8
CPC RECEIPT ASSEMBLY SIZE 17-28

Also in the Series | AMP CPC



Circular Connector Adapters(7)



Circular Connector Boots & Strain Relief(6)



Circular Connector Caps & Covers(16)



Circular Connector Hardware(3)



Circular Connector Keying Plugs(2)



Circular Connector Seals(36)



Circular Power Connectors(516)



Insertion & Extraction Tools(1)

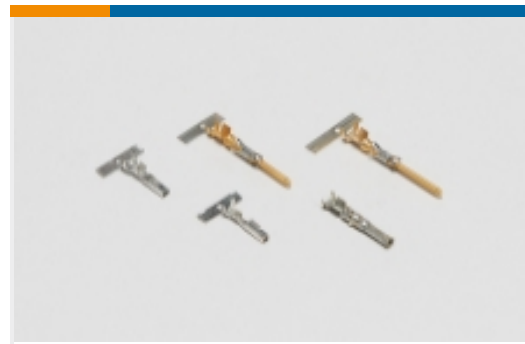

Power Contacts(6)

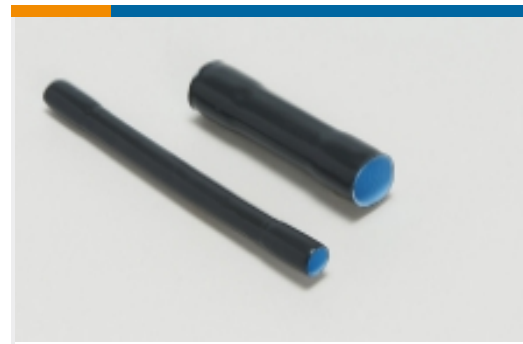

Sealing Sleeves(2)



Unscreened Circular Connector Backshells & Clamps(56)

Customers Also Bought



TE Part #211398-4
CPC RECPT. SIZE 13-7,THRD INST



TE Part #86657-2
FFC RECPT CONTACT-L P



TE Part #206038-2
CPC SERIES 2



TE Part #206322-9
CPC CABLE CLAMPS



TE Part #205839-3
CPC PLUG ASSEMBLY SIZE 17-28

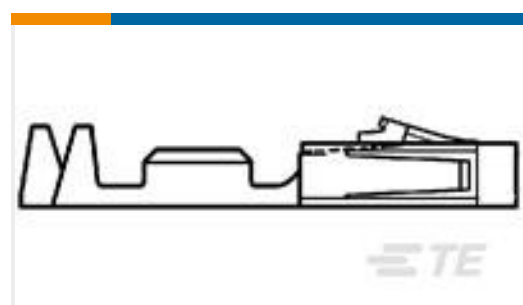

TE Part #104481-4
SHORT POINT CONT 30 DPLX STMPD

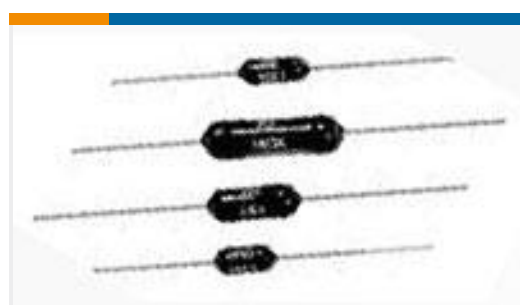

TE Part #2-1879642-0
H8 50K 0.1% 10PPM

Documents

Product Drawings

CPC PLUG ASSEMBLY SIZE 17-28

English

CAD Files

3D PDF

English

Customer View Model

ENG_CVM_206039-1_F.2d_dxf.zip



English

Customer View Model

[ENG_CVM_206039-1_F.3d_igs.zip](#)

English

Customer View Model

[ENG_CVM_206039-1_F.3d_stp.zip](#)

English

[3D PDF](#)

3D

Customer View Model

[ENG_CVM_CVM_206039-1_N.2d_dxf.zip](#)

English

Customer View Model

[ENG_CVM_CVM_206039-1_N.3d_igs.zip](#)

English

Customer View Model

[ENG_CVM_CVM_206039-1_N.3d_stp.zip](#)

English

By downloading the CAD file I accept and agree to the [Terms and Conditions](#) of use.

Datasheets & Catalog Pages

[AMP Circular Connectors for Commercial Signal & Power Applications](#)

English

Product Specifications

[Connector, Circular Plastic](#)

English

[Product Specification](#)

English

Product Environmental Compliance

[MD_206039-1_08232017021_dmtec](#)

English

[MD_206039-1_08232017021_dmtec](#)

English

Instruction Sheets

[Instruction Sheet \(U.S.\)](#)

English

Agency Approvals

[UL Report](#)

English