

207088-1 ✓ ACTIVE

AMP | AMP Metrimate

TE Internal #: 207088-1

Rectangular Boots & Strain Relief, Strain Relief Kit, Nylon, Black, 24

Position, -55 – 130 °C [-67 – 266 °F], AMP Metrimate

[View on TE.com >](#)



Connectors > Rectangular Connectors > Rectangular Connector Accessories > Rectangular Boots & Strain Relief



Protection & Strain Relief Accessory Type: **Strain Relief Kit**

Primary Product Material: **Nylon**

Primary Product Color: **Black**

Number of Positions: **24**

Sealable: **No**

## Features

### Product Type Features

Protection & Strain Relief Accessory Type	Strain Relief Kit
Sealable	No
Product Type	Accessory

### Configuration Features

Number of Positions	24
---------------------	----

### Body Features

Primary Product Material	Nylon
Primary Product Color	Black

### Usage Conditions

Operating Temperature Range	-55 – 130 °C[-67 – 266 °F]
-----------------------------	----------------------------

### Industry Standards

UL File Number	E28476
VDE Tested	Yes
Agency/Standard	CSA, UL
CSA File Number	LR16455
UL Rating	Certified, Recognized

### Packaging Features

Packaging Method	Bag
------------------	-----



Packaging Quantity 1

### Product Compliance

[For compliance documentation, visit the product page on TE.com>](#)

EU RoHS Directive 2011/65/EU	Compliant
EU ELV Directive 2000/53/EC	Compliant
China RoHS 2 Directive MIIT Order No 32, 2016	No Restricted Materials Above Threshold
EU REACH Regulation (EC) No. 1907/2006	Current ECHA Candidate List: JUNE 2022 (224) Candidate List Declared Against: JAN 2022 (223) SVHC > Threshold: Not Yet Reviewed
Halogen Content	Not Low Halogen - contains Br or Cl > 900 ppm.
Solder Process Capability	Not applicable for solder process capability

#### Product Compliance Disclaimer

This information is provided based on reasonable inquiry of our suppliers and represents our current actual knowledge based on the information they provided. This information is subject to change. The part numbers that TE has identified as EU RoHS compliant have a maximum concentration of 0.1% by weight in homogenous materials for lead, hexavalent chromium, mercury, PBB, PBDE, DBP, BBP, DEHP, DIBP, and 0.01% for cadmium, or qualify for an exemption to these limits as defined in the Annexes of Directive 2011/65/EU (RoHS2). Finished electrical and electronic equipment products will be CE marked as required by Directive 2011/65/EU. Components may not be CE marked. Additionally, the part numbers that TE has identified as EU ELV compliant have a maximum concentration of 0.1% by weight in homogenous materials for lead, hexavalent chromium, and mercury, and 0.01% for cadmium, or qualify for an exemption to these limits as defined in the Annexes of Directive 2000/53/EC (ELV). Regarding the REACH Regulation, the information TE provides on SVHC in articles for this part number is based on the latest European Chemicals Agency (ECHA) 'Guidance on requirements for substances in articles' posted at this URL: <https://echa.europa.eu/guidance-documents/guidance-on-reach>

### Compatible Parts



Also in the Series | [AMP Metrimate](#)



Insertion & Extraction Tools(1)

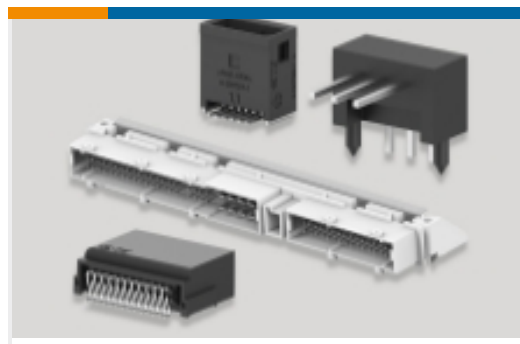

PCB Headers & Receptacles(83)

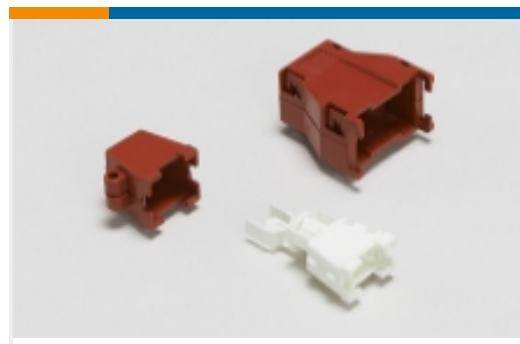

Rectangular Boots & Strain Relief(5)

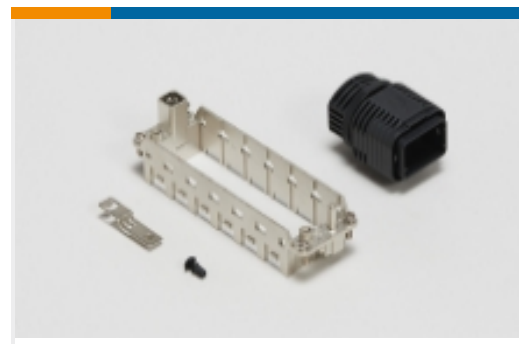

Rectangular Connector Hardware(3)



Rectangular Connector Housings(35)

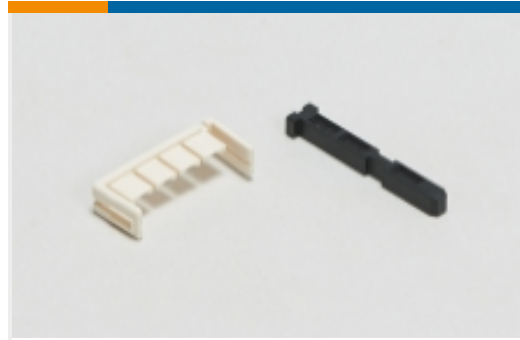

Rectangular Connector Keying Plugs(1)



Rectangular Contact Inserts(4)



Rectangular Power Connectors(2)



Standard Rectangular Connectors(5)

## Customers Also Bought



TE Part #T4061220004-005  
M8 CABLE RA M 5M 4POS PUR CABLE

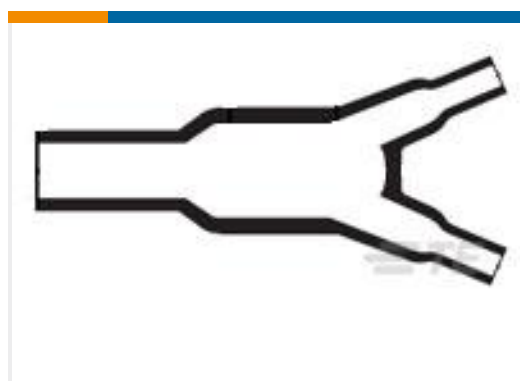

TE Part #811032-000  
382A012-12-0

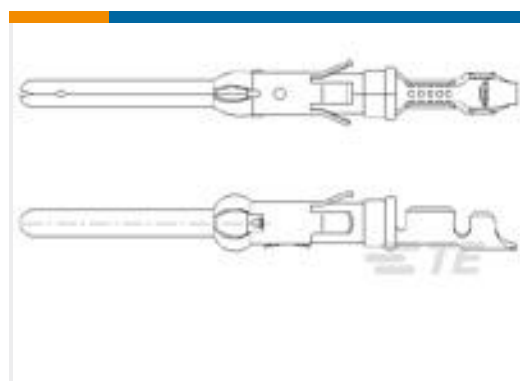

TE Part #1-163081-1  
.062 DIA PIN ASSY 3+



TE Part #917242-6  
DYNAMIC D-3500 WTW TAB HSG 12P



TE Part #7-2151022-7  
OCEAN\_2.0\_SPARE\_PART\_KIT-055F070F



TE Part #073863-000  
55A1831-16-MST3-9CS2275



TE Part #7-2151500-7  
OCEAN\_2.0\_SPARE\_PART\_KIT-090F130F



TE Part #7-2266273-7  
OCEAN\_2.0\_SPARE\_PART\_KIT-S-110F190F

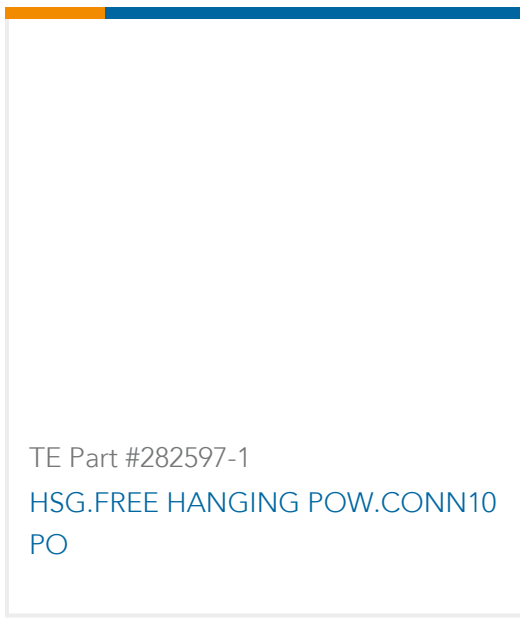

## Documents

### Product Drawings

[METRIMATE,STR REL KIT,24P](#)

English

### CAD Files

[3D PDF](#)

English

[Customer View Model](#)

[ENG\\_CVM\\_207088-1\\_E.2d\\_dxf.zip](#)

English

[Customer View Model](#)

[ENG\\_CVM\\_207088-1\\_E.3d\\_igs.zip](#)

English

[Customer View Model](#)

[ENG\\_CVM\\_207088-1\\_E.3d\\_stp.zip](#)

English

By downloading the CAD file I accept and agree to the [Terms and Conditions](#) of use.

### Datasheets & Catalog Pages

[METRIMATE\\_PIN\\_SOCKET\\_CATALOG](#)

English

### Product Specifications

[Application Specification](#)

English

[Application Specification](#)

English

[METRIMATE Self-Locking Connectors](#)

Japanese

[Application Specification](#)

Japanese

### Product Environmental Compliance

[MD\\_207088-1\\_06222016856\\_dmtec](#)

English

[MD\\_207088-1\\_06222016856\\_dmtec](#)



English

---

**Instruction Sheets**

**Instruction Sheet (U.S.)**

English

---

**Agency Approvals**

**CSA Certificate**

English