

1969295-4 ✓ ACTIVE

FASTON | FASTON 250

TE Internal #: 1969295-4

Crimp Terminal Housings, Receptacle, Receptacle, 1 Position, Straight, UL 94V-0, Black, Nylon, Cable Mount (Free-Hanging), Carton, FASTON 250

[View on TE.com >](#)



Terminals & Splices > Terminal Housings, Insulation Sleeves & Blocks > Crimp Terminal Housings



Terminal Type: **Receptacle**

Housing Type: **Receptacle**

Number of Positions: **1**

Terminal Orientation: **Straight**

UL Flammability Rating: **UL 94V-0**

## Features

### Product Type Features

Terminates To	Wire & Cable
Product Type	Terminal Housing
Glow Wire Rating	GWT 750°C (Without Flame)
Sealable	No
Housing Type	Receptacle
Insulated	No

### Configuration Features

Number of Positions	1
---------------------	---

### Body Features

Primary Product Color	Black
-----------------------	-------

### Contact Features

Terminal Type	Receptacle
Terminal Orientation	Straight
Contact Mating Retention	Without



### Mechanical Attachment

Mating Alignment Type	None
Mating Retention Type	Latch
Mating Alignment	Without
Crimp Terminal Housing Mounting Style	Cable Mount (Free-Hanging)

### Housing Features

Housing Material	Nylon
Centerline (Pitch)	12.8 mm[.504 in]

### Dimensions

Length	24.92 mm[.981 in]
--------	-------------------

### Usage Conditions

Operating Temperature Range	-40 – 130 °C[-40 – 266 °F]
-----------------------------	----------------------------

### Industry Standards

UL Flammability Rating	UL 94V-0
------------------------	----------

### Packaging Features

Packaging Quantity	1
Packaging Method	Carton

### Product Compliance

[For compliance documentation, visit the product page on TE.com>](#)

EU RoHS Directive 2011/65/EU	Compliant
EU ELV Directive 2000/53/EC	Compliant
China RoHS 2 Directive MIIT Order No 32, 2016	No Restricted Materials Above Threshold
EU REACH Regulation (EC) No. 1907/2006	Current ECHA Candidate List: JUNE 2022 (224) Candidate List Declared Against: JAN 2022 (223) SVHC > Threshold: Not Yet Reviewed
Halogen Content	Not Low Halogen - contains Br or Cl > 900 ppm.
Solder Process Capability	Not reviewed for solder process capability

Product Compliance Disclaimer

This information is provided based on reasonable inquiry of our suppliers and represents our current actual knowledge based on the information they provided. This information is subject to change. The part numbers that TE has identified as EU RoHS compliant have a maximum concentration of 0.1% by weight in homogenous materials for lead, hexavalent chromium, mercury, PBB, PBDE, DBP, BBP, DEHP, DIBP, and 0.01% for cadmium, or qualify for an exemption to these limits as defined in the Annexes of Directive 2011/65/EU (RoHS2). Finished electrical and electronic equipment products will be CE marked as required by Directive 2011/65/EU. Components may not be CE marked. Additionally, the part numbers that TE has identified as EU ELV compliant have a maximum concentration of 0.1% by weight in homogenous materials for lead, hexavalent chromium, and mercury, and 0.01% for cadmium, or qualify for an exemption to these limits as defined in the Annexes of Directive 2000/53/EC (ELV). Regarding the REACH Regulation, the information TE provides on SVHC in articles for this part number is based on the latest European Chemicals Agency (ECHA) 'Guidance on requirements for substances in articles' posted at this URL: <https://echa.europa.eu/guidance-documents/guidance-on-reach>

## Compatible Parts



TE Part # 360041-1  
187 FASTON HSG.,TAB,1 POS,  
NATURAL



TE Part # 2238173-3  
250 FASTON,REC.,22-12 AWG,TPBR



TE Part # 2238196-3  
250 FASTON,REC.,18-14 AWG,TPBR

## Also in the Series | FASTON 250



Compression Connectors(4)



Crimp Terminal Housings(143)



Insertion & Extraction Tools(6)



Magnet Wire Terminals(1)



PCB Terminals(144)

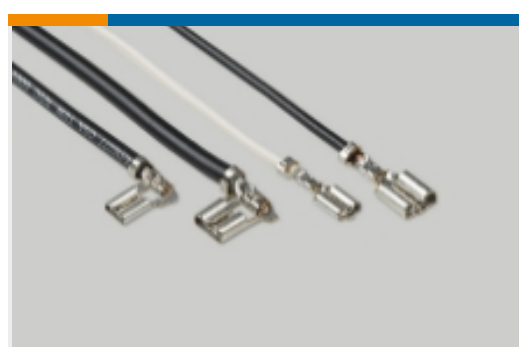

Quick Disconnects(456)



Splices(4)

## Customers Also Bought

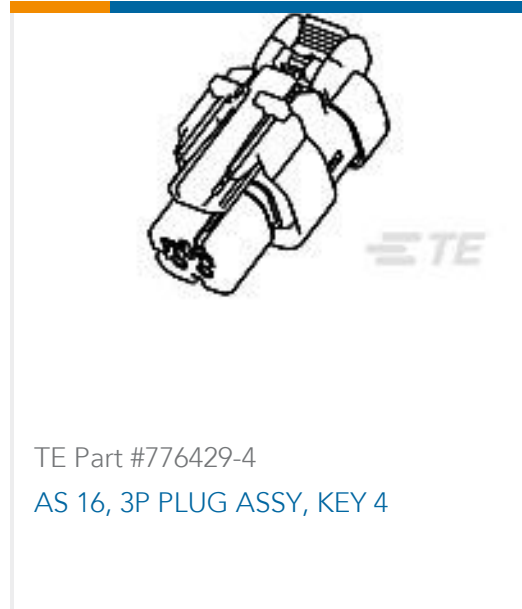
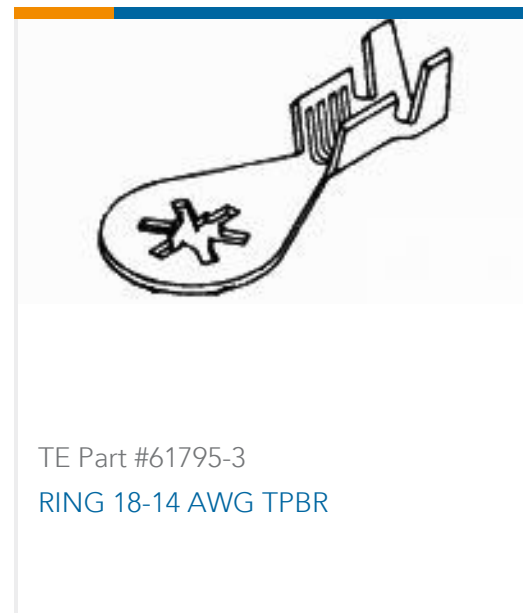

## Documents

### Product Drawings

250 FASTON HSG.,REC.,2 POS,NATURAL

English

### CAD Files

3D PDF

3D

Customer View Model

[ENG\\_CVM\\_CVM\\_1969295-4\\_A8.2d\\_dxf.zip](#)

English

Customer View Model

[ENG\\_CVM\\_CVM\\_1969295-4\\_A8.3d\\_igs.zip](#)

English

Customer View Model

[ENG\\_CVM\\_CVM\\_1969295-4\\_A8.3d\\_stp.zip](#)

English

By downloading the CAD file I accept and agree to the [Terms and Conditions](#) of use.

### Product Environmental Compliance

[TE Material Declaration](#)

English