

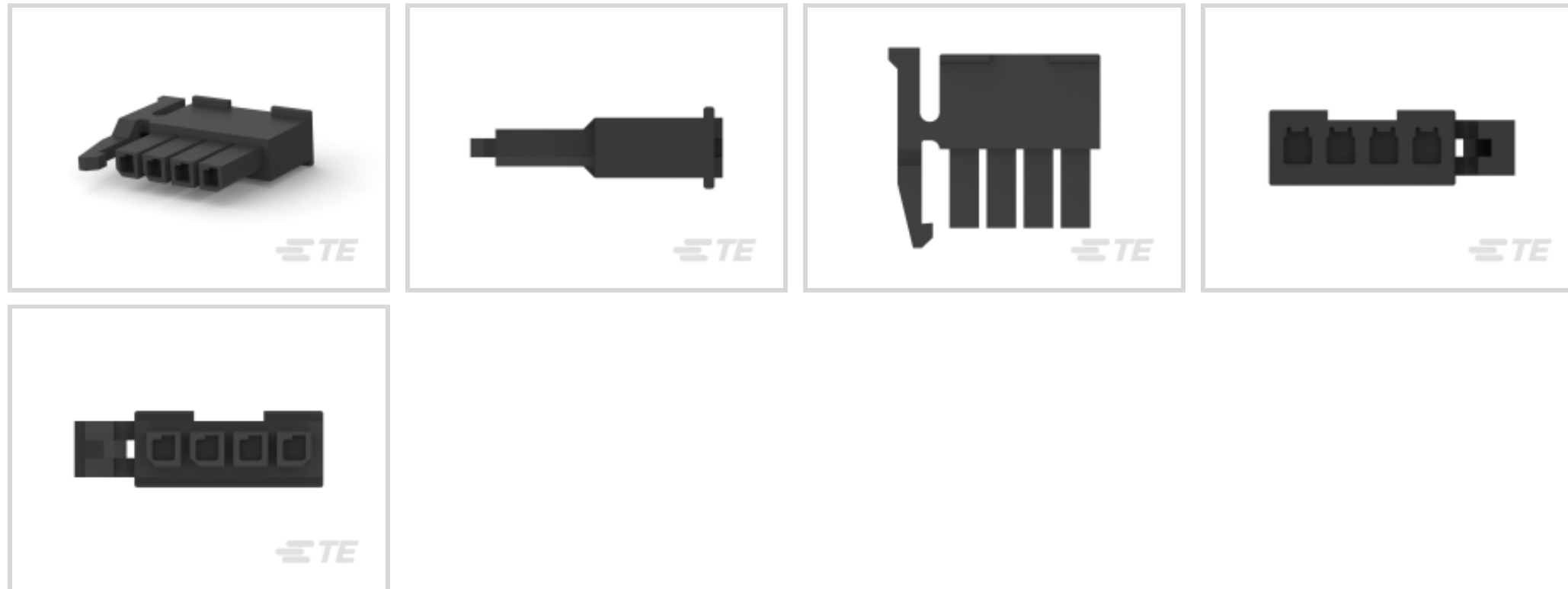

Connectors > Power Connectors > Rectangular Power > Rectangular Power Connectors



Rectangular Power Connector Type: **Housing**

Connector & Housing Type: **Receptacle**

Connector System: **Wire-to-Board**

Number of Positions: **4**

Centerline (Pitch): **3 mm [ .118 in ]**

### Features

#### Product Type Features

Rectangular Power Connector Type	Housing
Connector & Housing Type	Receptacle
Connector System	Wire-to-Board
Sealable	No
Connector & Contact Terminates To	Wire & Cable

#### Configuration Features

Number of Positions	4
Number of Rows	1

#### Electrical Characteristics

Operating Voltage	250 VDC
-------------------	---------

#### Contact Features

Contact Layout	Inline
Contact Retention Within Housing	Without
Contact Type	Receptacle



### Termination Features

Termination Method to Wire & Cable	Crimp
------------------------------------	-------

### Mechanical Attachment

Connector Mounting Type	Cable Mount (Free-Hanging)
-------------------------	----------------------------

### Housing Features

Centerline (Pitch)	3 mm [.118 in]
--------------------	----------------

Housing Color	Black
---------------	-------

Housing Material	Nylon
------------------	-------

### Usage Conditions

Operating Temperature Range	-40 – 105 °C [-40 – 221 °F]
-----------------------------	-----------------------------

### Operation/Application

Circuit Application	Power & Signal
---------------------	----------------

### Identification Marking

Circuit Identification Feature	With
--------------------------------	------

### Industry Standards

UL Flammability Rating	UL 94V-0
------------------------	----------

Glow Wire Rating	Standard Part - Not Glow Wire
------------------	-------------------------------

Agency/Standard Number	E28476
------------------------	--------

VDE Tested	No
------------	----

### Packaging Features

Packaging Method	Box & Tray, Tray
------------------	------------------

Packaging Quantity	3000
--------------------	------

### Product Compliance

[For compliance documentation, visit the product page on TE.com>](#)

EU RoHS Directive 2011/65/EU	Compliant
------------------------------	-----------

EU ELV Directive 2000/53/EC	Compliant
-----------------------------	-----------

China RoHS 2 Directive MIIT Order No 32, 2016	No Restricted Materials Above Threshold
---	---

EU REACH Regulation (EC) No. 1907/2006	Current ECHA Candidate List: JUNE 2022 (224) Candidate List Declared Against: JAN 2021 (211) SVHC > Threshold:
--	--



Not Yet Reviewed

Halogen Content

Low Halogen - Br, Cl, F, I < 900 ppm per homogenous material. Also BFR/CFR/PVC Free

Solder Process Capability

Not applicable for solder process capability

Product Compliance Disclaimer

This information is provided based on reasonable inquiry of our suppliers and represents our current actual knowledge based on the information they provided. This information is subject to change. The part numbers that TE has identified as EU RoHS compliant have a maximum concentration of 0.1% by weight in homogenous materials for lead, hexavalent chromium, mercury, PBB, PBDE, DBP, BBP, DEHP, DIBP, and 0.01% for cadmium, or qualify for an exemption to these limits as defined in the Annexes of Directive 2011/65/EU (RoHS2). Finished electrical and electronic equipment products will be CE marked as required by Directive 2011/65/EU. Components may not be CE marked. Additionally, the part numbers that TE has identified as EU ELV compliant have a maximum concentration of 0.1% by weight in homogenous materials for lead, hexavalent chromium, and mercury, and 0.01% for cadmium, or qualify for an exemption to these limits as defined in the Annexes of Directive 2000/53/EC (ELV). Regarding the REACH Regulation, the information TE provides on SVHC in articles for this part number is based on the latest European Chemicals Agency (ECHA) 'Guidance on requirements for substances in articles' posted at this URL: <https://echa.europa.eu/guidance-documents/guidance-on-reach>

### Compatible Parts



TE Part # 2029030-4  
4P MICRO MNL HDR ASSY SR SIDE L



TE Part # 1445049-4  
FREE HANG SNGL ROW HSG 4 POS



TE Part # 1445022-4  
MICRO MNL RFECEPT HSG SINGLE R



TE Part # 2-1445100-4  
MICRO MNL HDR ASSY S/ROW LF



TE Part # 2-1445096-4  
MICRO MNL HDR ASSY SINGLE ROW



TE Part # 2-1445055-4  
MICRO MNL HDR ASSY S/ROW LF



TE Part # 2-1445053-4  
MICRO MNL HDR ASSY S/ROW LF



TE Part # 2-1445094-4  
MICRO MNL HDR ASSY S/ROW AU LF



TE Part # 2-1445093-4  
MICRO MNL HDR ASSY S/ROW AU LF



TE Part # 2008571-2  
2 POS MICRO MNL, TOP LATCH, BL



TE Part # 2-1445085-4  
micro mnl hdr assy s/row au lf



TE Part # 2-1445054-4  
MICRO MNL HDR ASSY S/ROW LF



TE Part # 2-1445087-4  
MICRO MNL HDR ASSY S/ROW AU LF



TE Part # 2-1445088-4  
MICRO MNL HDR ASSY S/ROW AU LF



TE Part # 2-1445089-4  
MICRO MNL HDR ASSY S/ROW AU LF



TE Part # 2-1445098-4  
MICRO MNL HDR ASSY S/ROW AU LF



TE Part # 2008570-4  
4 POS MICRO MNL, SIDE LATCH, B



TE Part # 2008571-3  
3 POS MICRO MNL, TOP LATCH, BL



TE Part # 2029047-2  
2P MICRO MNL RCPT HSG SR SIDE



TE Part # 2029047-3  
3P MICRO MNL RCPT HSG SR SIDE

Also in the Series | **Micro MATE-N-LOK**

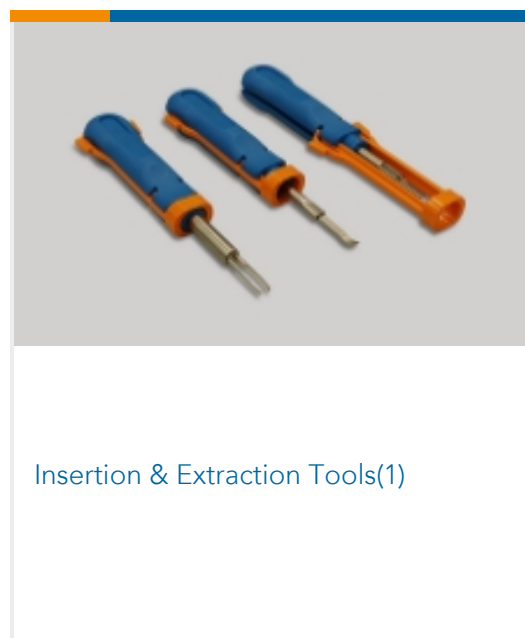

Insertion & Extraction Tools(1)

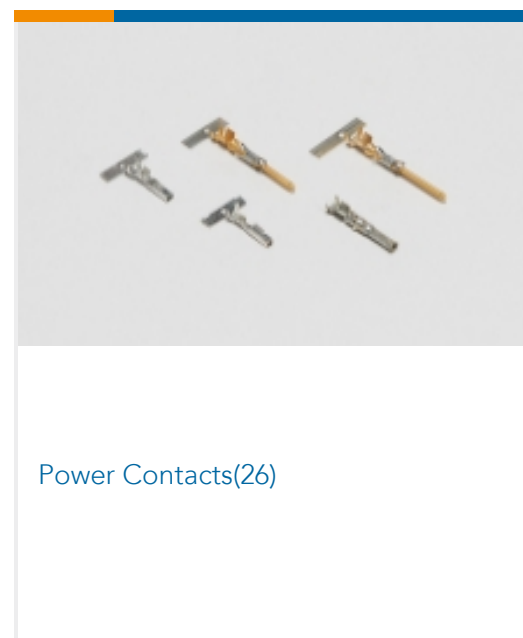

Power Contacts(26)

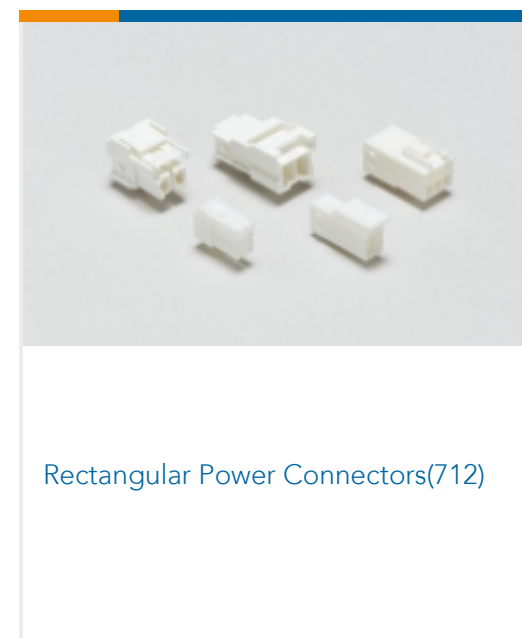

Rectangular Power Connectors(712)

Customers Also Bought

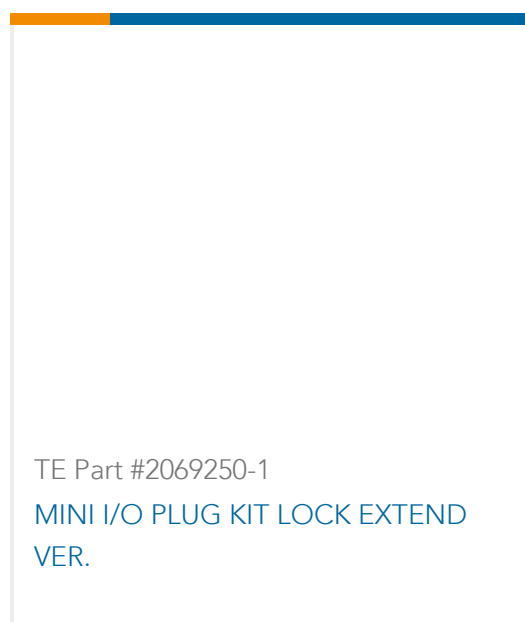

TE Part #2069250-1  
MINI I/O PLUG KIT LOCK EXTEND  
VER.



TE Part #2098252-3  
PIN, SF, SIZE 16, 14-16 AWG, NI/SN



TE Part #7-215460-4  
MICRO-MATCH FSID P



TE Part #170341-1  
FF 250 TAB 14-12AWG BR WITHOUT  
LATCH

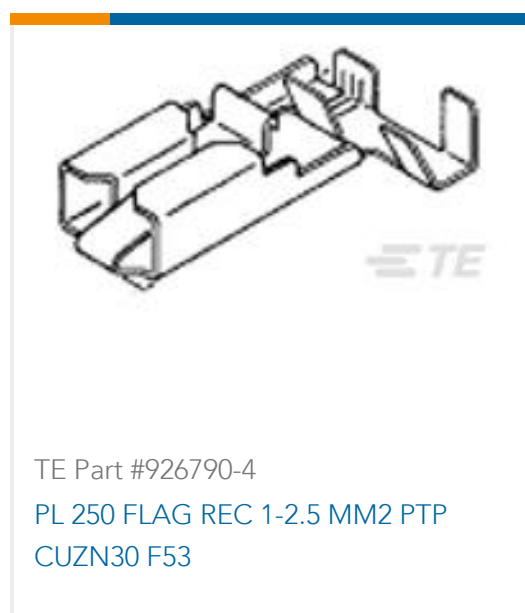

TE Part #926790-4  
PL 250 FLAG REC 1-2.5 MM2 PTP  
CUZN30 F53



TE Part #207604-1  
METRIMATE,STR REL KIT,36P

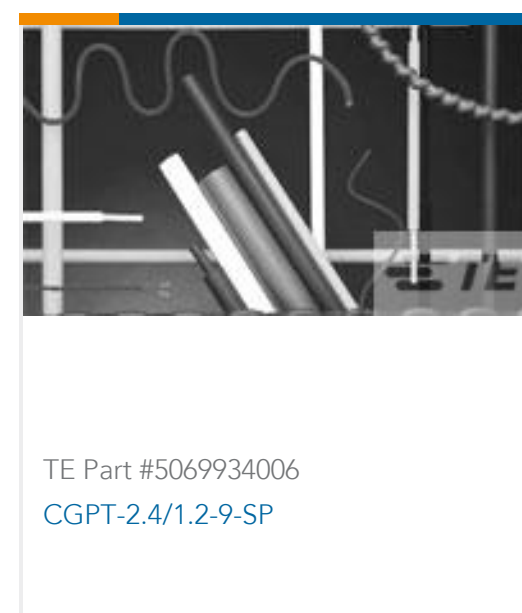

TE Part #5069934006  
CGPT-2.4/1.2-9-SP



TE Part #1648110-1  
221-0010-01100=SA CONN,PIN

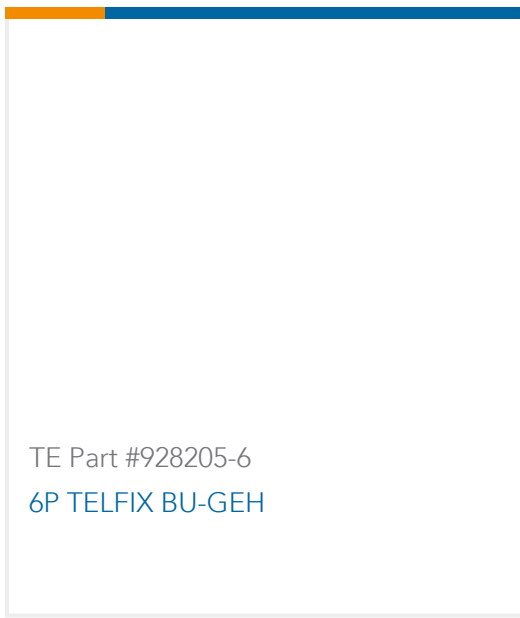

## Documents

### CAD Files

[3D PDF](#)

[3D](#)

**Customer View Model**

[ENG\\_CVM\\_CVM\\_2029047-4\\_B.2d\\_dxf.zip](#)

English

**Customer View Model**

[ENG\\_CVM\\_CVM\\_2029047-4\\_B.3d\\_igs.zip](#)

English

**Customer View Model**

[ENG\\_CVM\\_CVM\\_2029047-4\\_B.3d\\_stp.zip](#)

English

By downloading the CAD file I accept and agree to the [Terms and Conditions](#) of use.

### Datasheets & Catalog Pages

[SOFT\\_SHELL\\_PIN\\_AND\\_SOCKET\\_CONNECTORS\\_CATALOG](#)

English

[MICRO MATE-N-LOK CONNECTOR SYSTEM](#)

English

[1773458-4\\_MICRO\\_MATE\\_N\\_LOK\\_CONNECTOR\\_SYSTEM\\_QRG](#)

English

[LOW\\_PROFILE\\_MICRO\\_M-N-L](#)

English

### Product Specifications

[Product Specification](#)

English