

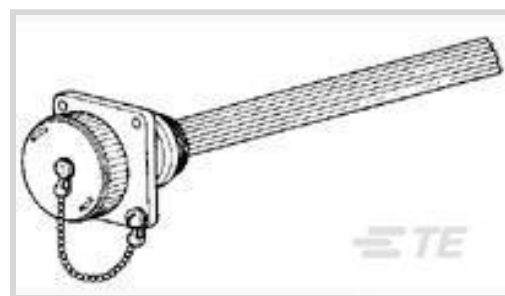

Connectors > Circular Connectors > Circular Connector Accessories > Circular Connector Caps & Covers



Protection & Strain Relief Accessory Type: **Sealing Cap**

Compatible With Circular Connector Shell Size: **23**

Cap to Flange Attachment: **Metal Bead Chain**

Operating Temperature Range: **-55 – 105 °C [-67 – 221 °F]**

## Features

### Product Type Features

Product Type	Accessory
Protection & Strain Relief Accessory Type	Sealing Cap

### Body Features

Sealing Cap Material	Thermoplastic
Color	Black
Cap Material	Thermoplastic
Sealing Cap Flammability Rating	UL 94V-1
Sealing Gasket Material	Elastomer
Cable Clamp Color	Black

### Mechanical Attachment

Bead Chain Material	Nickel
Bead Chain Coupling Material	Nickel
Bead Chain Coupling Plating Material	Brass
Bead Chain Plating Material	Steel
Cap to Flange Attachment	Metal Bead Chain

### Usage Conditions

Operating Temperature Range	-55 – 105 °C[-67 – 221 °F]
-----------------------------	----------------------------

### Operation/Application

For Use With	Receptacle
--------------	------------



Compatible With Circular Connector Shell Size 23

### Packaging Features

Packaging Quantity	100
Packaging Method	Bag

### Product Compliance

[For compliance documentation, visit the product page on TE.com>](#)

EU RoHS Directive 2011/65/EU	Compliant
EU ELV Directive 2000/53/EC	Compliant
China RoHS 2 Directive MIIT Order No 32, 2016	No Restricted Materials Above Threshold
EU REACH Regulation (EC) No. 1907/2006	Current ECHA Candidate List: JUNE 2022 (224) Candidate List Declared Against: JAN 2022 (223) SVHC > Threshold: Not Yet Reviewed
Halogen Content	Low Halogen - Br, Cl, F, I < 900 ppm per homogenous material. Also BFR/CFR/PVC Free
Solder Process Capability	Not applicable for solder process capability

#### Product Compliance Disclaimer

This information is provided based on reasonable inquiry of our suppliers and represents our current actual knowledge based on the information they provided. This information is subject to change. The part numbers that TE has identified as EU RoHS compliant have a maximum concentration of 0.1% by weight in homogenous materials for lead, hexavalent chromium, mercury, PBB, PBDE, DBP, BBP, DEHP, DIBP, and 0.01% for cadmium, or qualify for an exemption to these limits as defined in the Annexes of Directive 2011/65/EU (RoHS2). Finished electrical and electronic equipment products will be CE marked as required by Directive 2011/65/EU. Components may not be CE marked. Additionally, the part numbers that TE has identified as EU ELV compliant have a maximum concentration of 0.1% by weight in homogenous materials for lead, hexavalent chromium, and mercury, and 0.01% for cadmium, or qualify for an exemption to these limits as defined in the Annexes of Directive 2000/53/EC (ELV). Regarding the REACH Regulation, the information TE provides on SVHC in articles for this part number is based on the latest European Chemicals Agency (ECHA) 'Guidance on requirements for substances in articles' posted at this URL: <https://echa.europa.eu/guidance-documents/guidance-on-reach>

### Compatible Parts



Also in the Series | AMP CPC

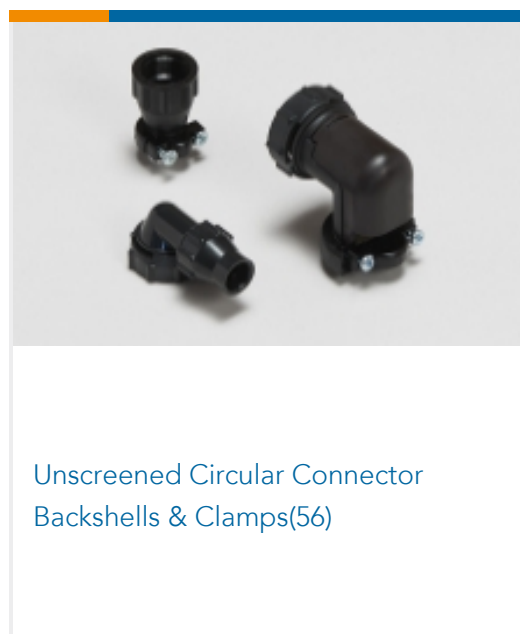
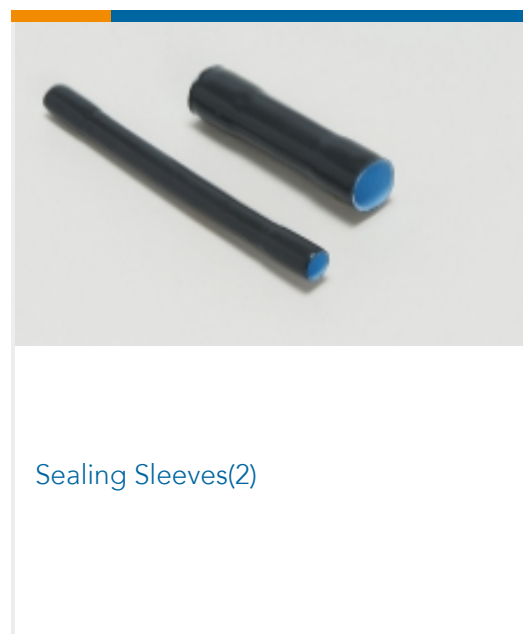
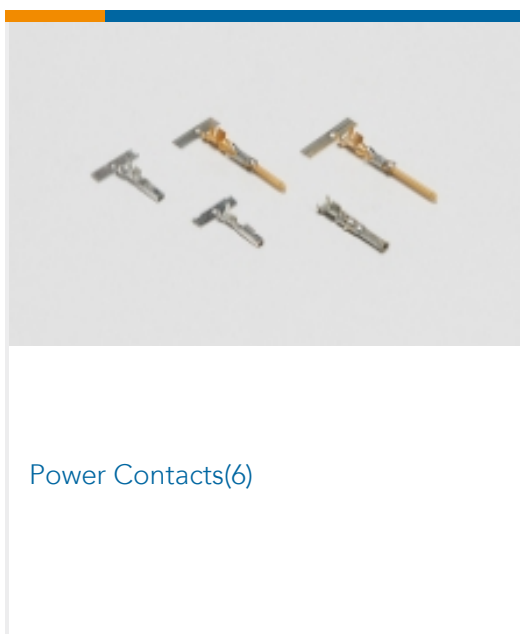
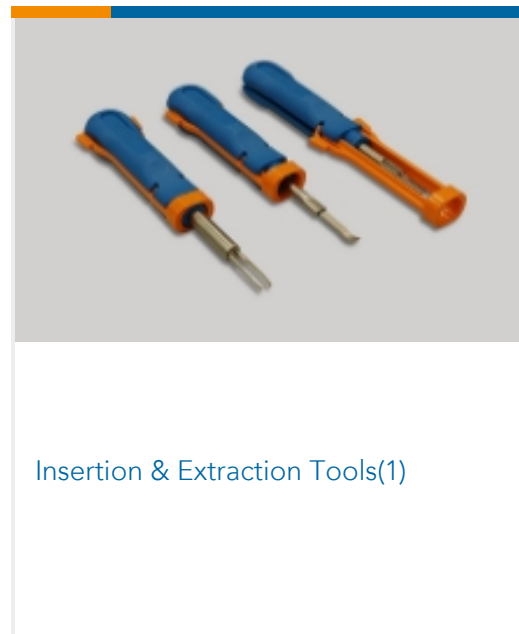
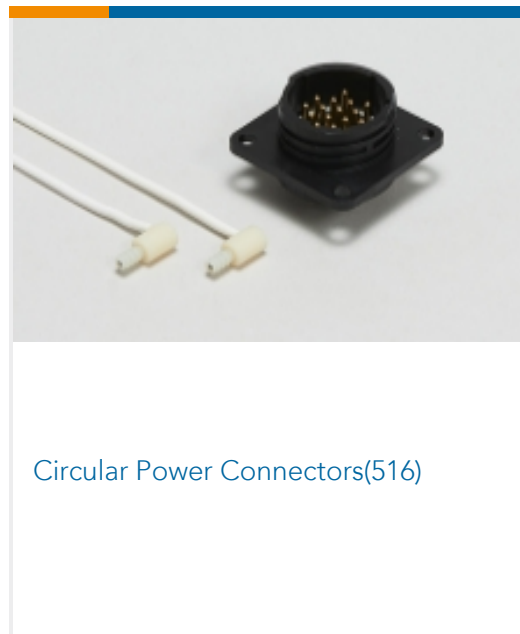
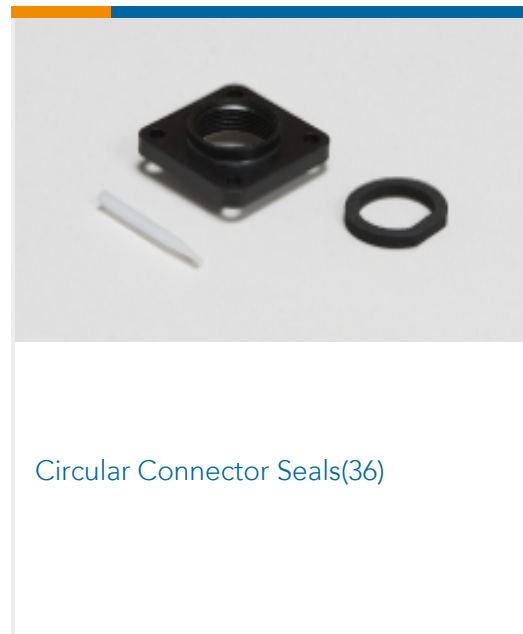
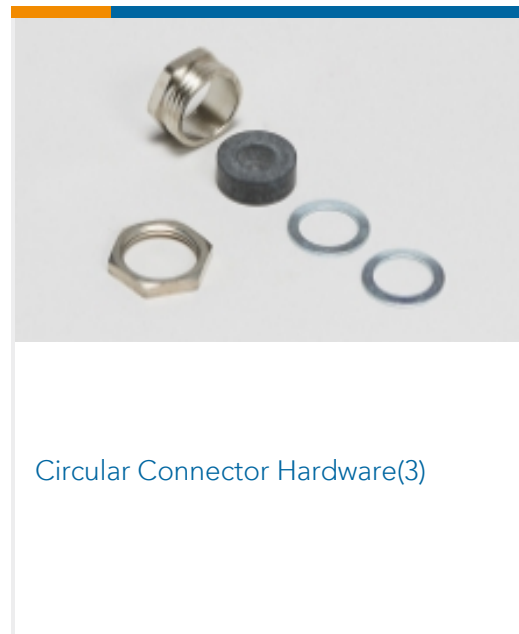
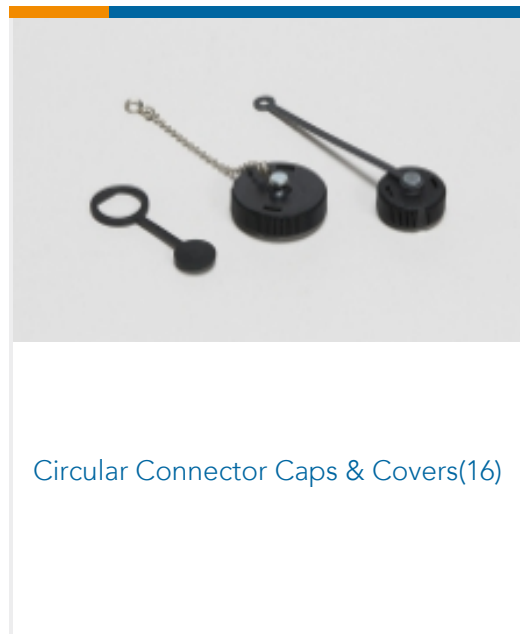
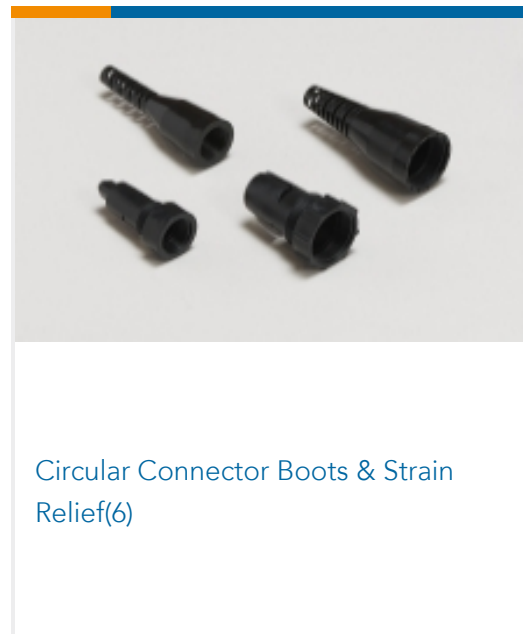
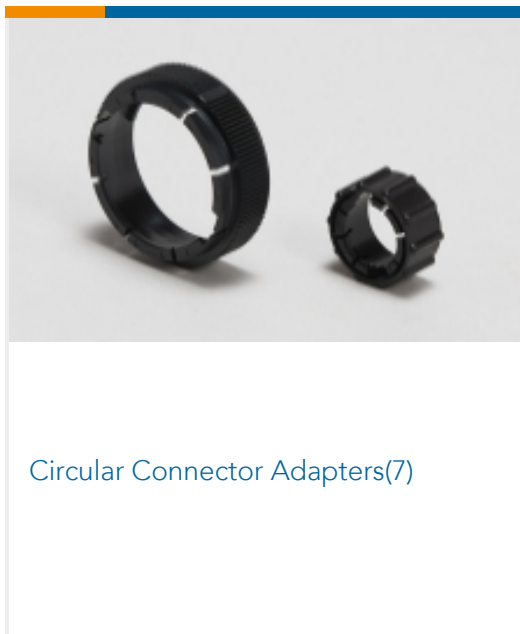

Customers Also Bought



TE Part #1658544-3  
CONT, PIN, PLATED, 20DF, STRIP, #22

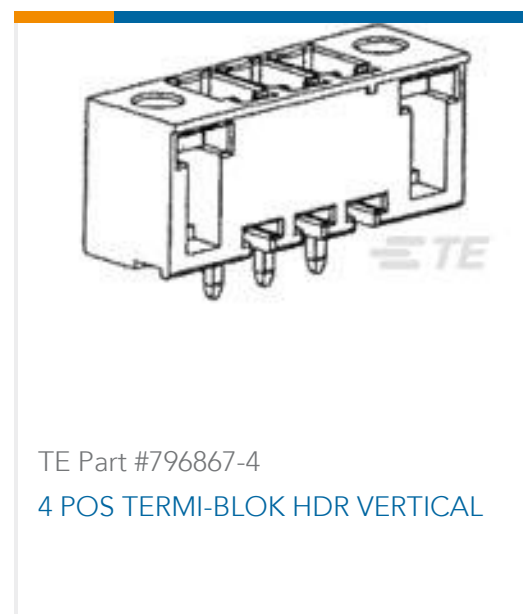

TE Part #796867-4  
4 POS TERMI-BLOK HDR VERTICAL



TE Part #1618241-5  
K81A235=RELAY, VACUUM, SPST-NO



TE Part #2-456403-6  
CRIMPER, WIRE .062" F"



TE Part #456407-3  
CRIMPER WIRE .100



TE Part #3-683453-8  
CRIMP, INS (110F X 060THK)

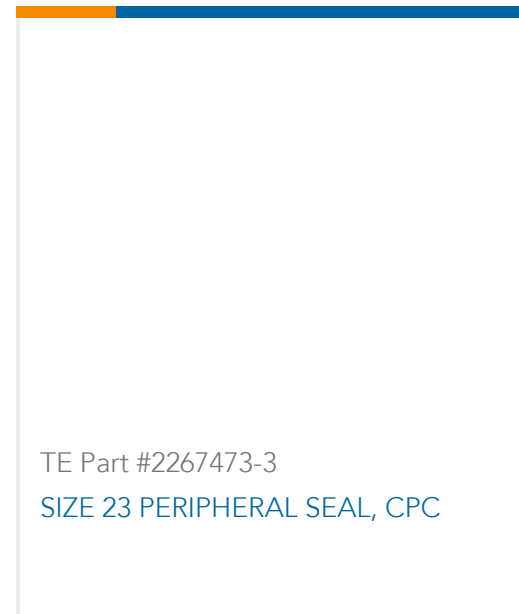

TE Part #2267473-3  
SIZE 23 PERIPHERAL SEAL, CPC

## Documents

### Product Drawings

#### SEALING CAP ASSY, SZ 23, CPC

English

### CAD Files

#### Customer View Model

[ENG\\_CVM\\_CVM\\_208680-1\\_H.2d\\_dxf.zip](#)

English

#### 3D PDF

3D

#### Customer View Model

[ENG\\_CVM\\_CVM\\_208680-1\\_H.3d\\_igs.zip](#)

English

#### Customer View Model

[ENG\\_CVM\\_CVM\\_208680-1\\_H.3d\\_stp.zip](#)

English

By downloading the CAD file I accept and agree to the [Terms and Conditions](#) of use.

### Datasheets & Catalog Pages

#### AMP Circular Connectors for Commercial Signal & Power Applications Continued

English

### Product Environmental Compliance

#### Product Compliance

English

#### Product Compliance

English



**Instruction Sheets**

[Instruction Sheet \(U.S.\)](#)

English

---

**Agency Approvals**

[CSA Certificate](#)

English