

1-968851-1 ✓ ACTIVE

AMP | AMP MCP Connector System

TE Internal #: 1-968851-1

Automotive Terminals, Receptacle, Mating Tab Width 2.8 mm [.11 in], Tab Thickness .031 in [.8 mm], 15 – 13 AWG Wire Size, AMP MCP Connector System

[View on TE.com >](#)



Terminals & Splices > Automotive Terminals > AMP MCP, RECEPTACLE AND TAB

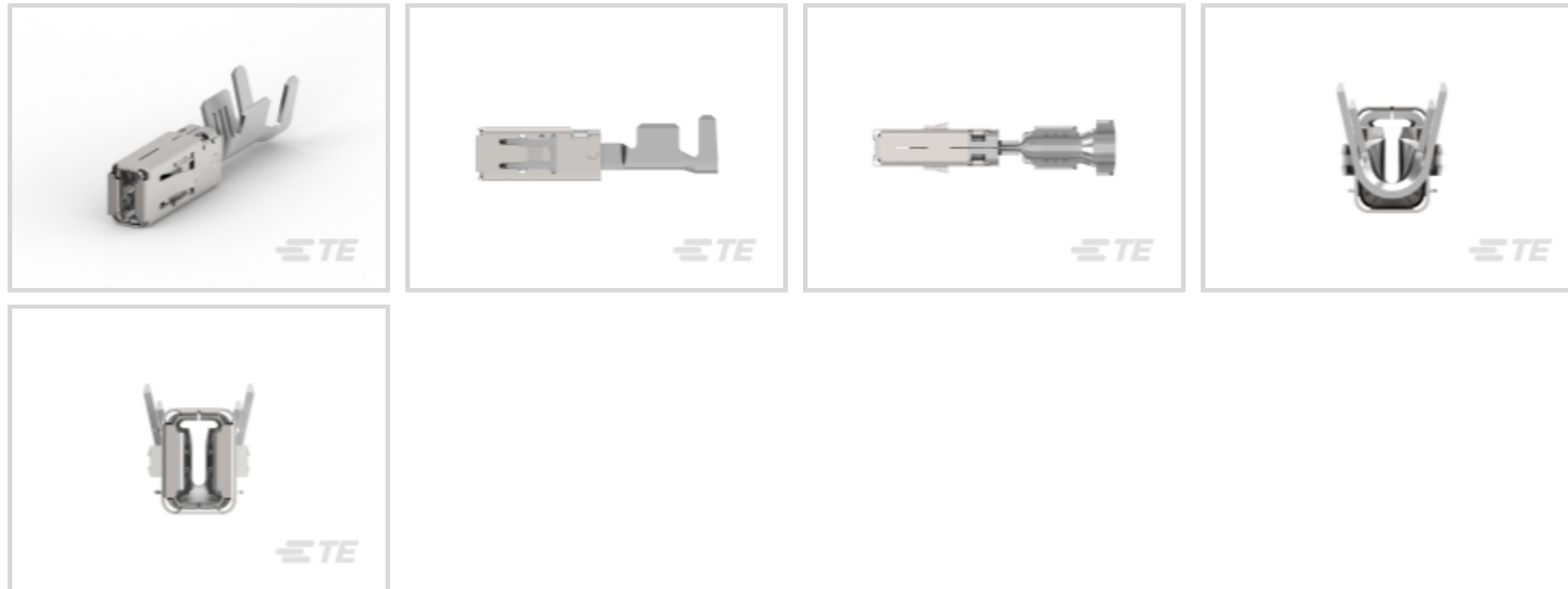

Terminal Type: **Receptacle**

Mating Tab Width: **2.8 mm [.11 in]**

Mating Tab Thickness: **.8 mm [.031 in]**

Terminal Transmits: **0 – 24 A (Low Power)**

Wire Size: **15 – 13 AWG**

[All AMP MCP, RECEPTACLE AND TAB \(125\)](#)

Features

Product Type Features

Receptacle Style	180°
Sealable	No
Primary Locking Feature	Locking Lance

Contact Features

Contact Size	2.8mm
Contact Fabrication	Stamped & Formed
Typical Current Rating	22 A
Crimp Type	F-Crimp
Terminal Type	Receptacle
Mating Tab Width	2.8 mm[.11 in]
Mating Tab Thickness	.8 mm[.031 in]
Interface Plating	Tin (Sn)
Contact Termination Area Plating Material	Tin (Sn)



Termination Features

Termination Method to Wire & Cable	Crimp
Product Terminates To	Wire

Dimensions

Wire Size	1.5 – 2.5 mm ²
Wire Size Search	13 AWG, 14 AWG, 15 AWG
Wire Insulation Diameter	1.9 – 3 mm [.075 – .118 in]

Usage Conditions

Insulation Option	Uninsulated
Operating Temperature (Max)	80 °C, 85 °C, 90 °C, 100 °C, 105 °C, 110 °C, 120 °C, 125 °C, 130 °C [176 °F][185 °F][194 °F][212 °F][221 °F][230 °F][248 °F][257 °F][266 °F]
Operating Temperature Range	-40 – 130 °C [-40 – 266 °F]

Operation/Application

Compatible With Wire Base Material	Copper
------------------------------------	--------

Industry Standards

Agency/Standard	LV214
-----------------	-------

Packaging Features

Packaging Method	Reel
Packaging Quantity	3500

Other

Terminal Transmits	0 – 24 A (Low Power)
--------------------	----------------------

Product Compliance

[For compliance documentation, visit the product page on TE.com>](#)

EU RoHS Directive 2011/65/EU	Compliant
EU ELV Directive 2000/53/EC	Compliant
China RoHS 2 Directive MIIT Order No 32, 2016	No Restricted Materials Above Threshold
EU REACH Regulation (EC) No. 1907/2006	Current ECHA Candidate List: JUNE 2022 (224) Candidate List Declared Against: JAN 2022 (223) SVHC > Threshold:

Not Yet Reviewed

Halogen Content

Low Halogen - Br, Cl, F, I < 900 ppm per homogenous material. Also BFR/CFR/PVC Free

Solder Process Capability

Not applicable for solder process capability

Product Compliance Disclaimer

This information is provided based on reasonable inquiry of our suppliers and represents our current actual knowledge based on the information they provided. This information is subject to change. The part numbers that TE has identified as EU RoHS compliant have a maximum concentration of 0.1% by weight in homogenous materials for lead, hexavalent chromium, mercury, PBB, PBDE, DBP, BBP, DEHP, DIBP, and 0.01% for cadmium, or qualify for an exemption to these limits as defined in the Annexes of Directive 2011/65/EU (RoHS2). Finished electrical and electronic equipment products will be CE marked as required by Directive 2011/65/EU. Components may not be CE marked. Additionally, the part numbers that TE has identified as EU ELV compliant have a maximum concentration of 0.1% by weight in homogenous materials for lead, hexavalent chromium, and mercury, and 0.01% for cadmium, or qualify for an exemption to these limits as defined in the Annexes of Directive 2000/53/EC (ELV). Regarding the REACH Regulation, the information TE provides on SVHC in articles for this part number is based on the latest European Chemicals Agency (ECHA) 'Guidance on requirements for substances in articles' posted at this URL: <https://echa.europa.eu/guidance-documents/guidance-on-reach>

Compatible Parts



TE Part # CAT-AM705-CH8173
AMP MCP, UNSEALED CONNECTOR HOUSING



TE Part # 1579007-1
AUSRUECKWERKZEUG



TE Part # 2305570-1
TERMINAL CUTTER, SIDE FEED



TE Part # CAT-L489-CH8172
LEAVYSEAL HOUSINGS



TE Part # 1-1452568-2
ACTION PIN 2,8X0,6



TE Part # CAT-M8793-CH8172
MQS, CONNECTOR HOUSING



TE Part # CAT-M9194-CH8172
MULTILOCK, CONNECTOR HOUSING



TE Part # CAT-A11-CH8172
1.5/2.8 CONNECTOR SYSTEM, HOUSING



TE Part # 1718149-1
AMP MCP 2.8 SOCKET HSG 16 POS. ASSY



TE Part # 2-1670442-9
38POS,MIXED,REC. HSG



TE Part # CAT-T319-CH8172
TH/.025 CONNECTOR SYSTEM, HOUSING



TE Part # 2151166-1
OCEAN_2.0_APPLICATOR-S-100F140OV



TE Part # 1801567-1
MINIFUSE HOLDER, 8 POS, MCP CONTACT



TE Part # 2-2151166-1
OCEAN_2.0_APPLICATOR-S-100F140OV



TE Part # 2-2151166-2
OCEAN_2.0_APPLICATOR-S-100F140OV



TE Part # 2151166-2
OCEAN_2.0_APPLICATOR-S-100F140OV



TE Part # 2209893-1
BCM 14P MCP2.8 SOCKET



TE Part # 2209895-1
BCM 14P MCP2.8 COVER ASSY



TE Part # 2236402-1
SINGLE WIRE SEAL,AMP MCP2.8



TE Part # 2379921-2
21POS,AMP MCP 2.8,REC HSG ASSY, UNSLD

Also in the Series | AMP MCP Connector System



Automotive Connector Caps & Covers (24)



Automotive Connector Locks & Position Assurance(7)

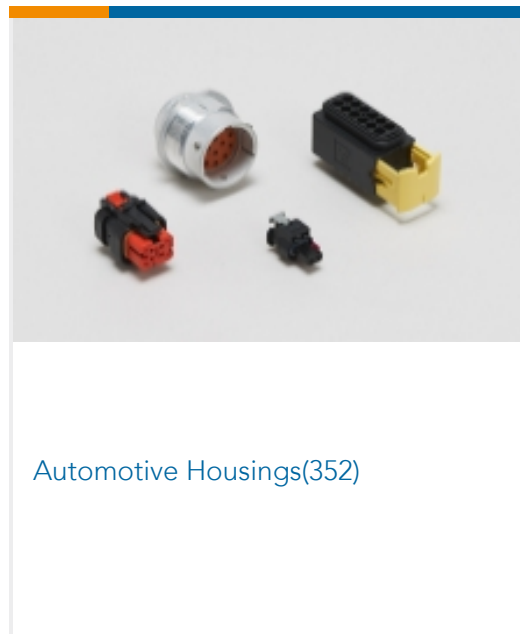

Automotive Housings(352)

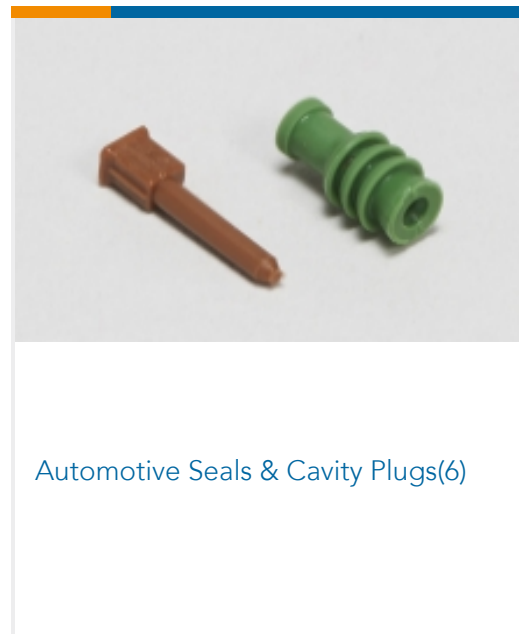

Automotive Seals & Cavity Plugs(6)

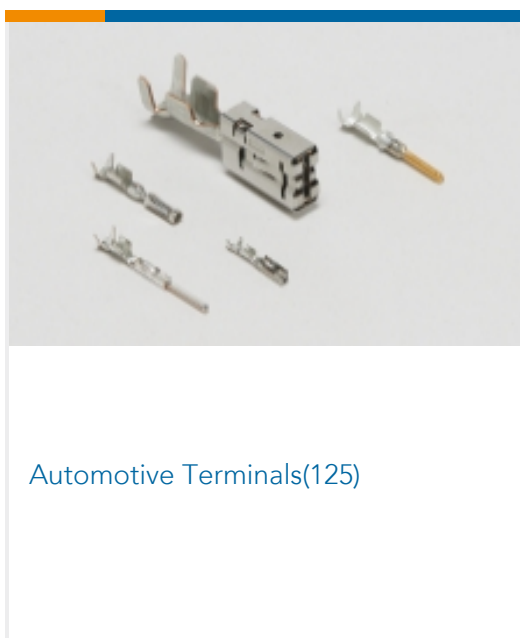

Automotive Terminals(125)

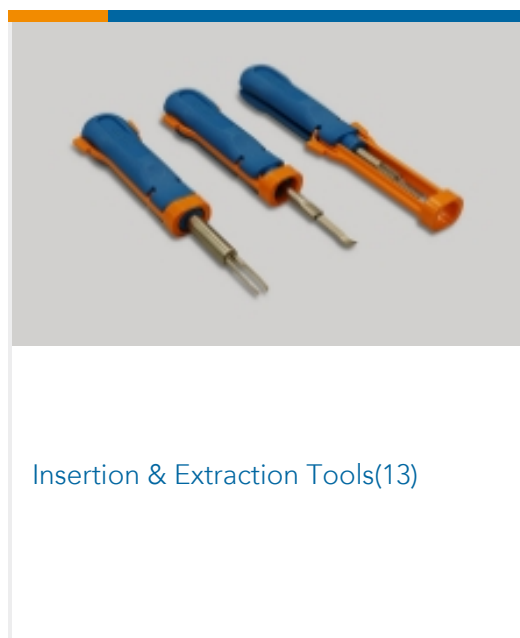

Insertion & Extraction Tools(13)

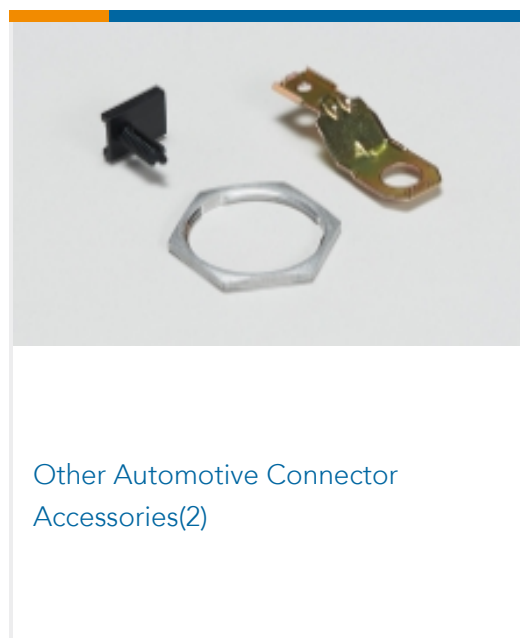

Other Automotive Connector Accessories(2)



PCB Headers & Receptacles(29)

Customers Also Bought



TE Part #1-968946-1
TAB 2.8x0.8 CONTACT CF SRC Sn



TE Part #1-967627-1
AMP MCP, UNSEALED CONNECTOR HOUSING



TE Part #444313-1
HSG. ASS'Y 9 POSN. COM.



TE Part #1241408-1
AMP MCP 6.3/4.8K, CONTACT

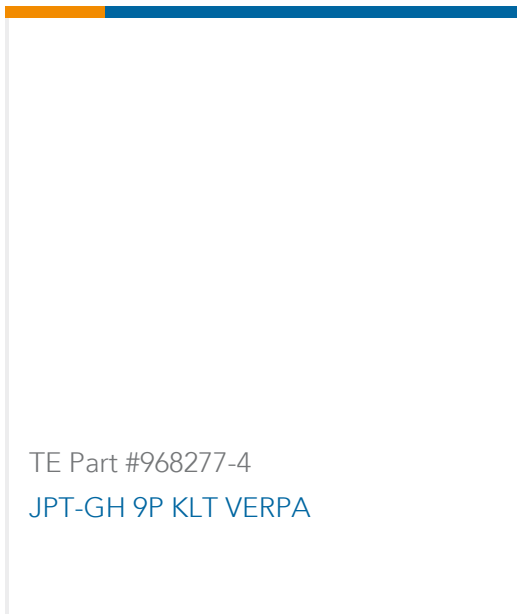

Documents

Product Drawings

[AMP MCP 2.8, CONTACT](#)

English

[AMP MCP 2.8, CONTACT](#)

English

CAD Files

[3D PDF](#)

3D

Customer View Model

[ENG_CVM_CVM_1-968851-1_E.2d_dxf.zip](#)

English

Customer View Model

[ENG_CVM_CVM_1-968851-1_E.3d_igs.zip](#)

English

Customer View Model

[ENG_CVM_CVM_1-968851-1_E.3d_stp.zip](#)

English

By downloading the CAD file I accept and agree to the [Terms and Conditions](#) of use.

Product Specifications

[Application Specification](#)

German

[Application Specification](#)

English

Product Environmental Compliance



[MD_1-968851-1_1008201607_dmtec](#)

English

[MD_1-968851-1_1008201607_dmtec](#)

English

Instruction Sheets

[UNSEALED GET/MCP 81/40 SLIDER LEVER TYPE CONNECTOR](#)

Japanese

[Instruction Sheet \(non U.S.\)](#)

Japanese