

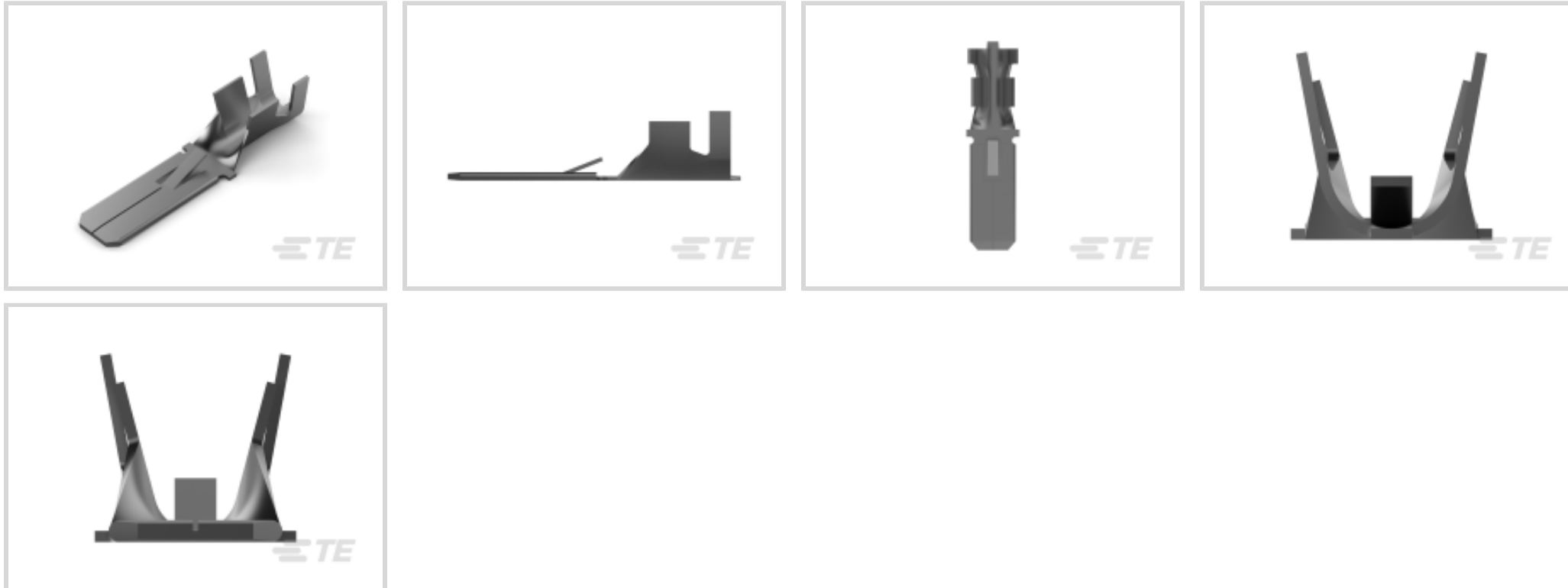

Terminals & Splices > Quick Disconnects



Quick Disconnect Terminal Type: **Tab**

Wire Size: **4 – 6.63 mm<sup>2</sup>**

Mating Tab Width: **6.35 mm [ .25 in ]**

Mating Tab Thickness: **.81 mm [ .032 in ]**

## Features

### Product Type Features

Terminates To	Wire & Cable
Wire Stop	No
Wire/Cable Type	Regular Wire
Insertion Force	Normal
Sealable	No

### Configuration Features

Connection Capacity	Single
---------------------	--------

### Contact Features

Quick Disconnect Terminal Type	Tab
Mating Tab Width	6.35 mm[.25 in]
Mating Tab Thickness	.81 mm[.032 in]
Terminal Orientation	Straight
Contact Base Material	Brass
Terminal Plating Material	Tin
Crimp Type	F-Crimp



Barrel Type	Open
-------------	------

### Mechanical Attachment

Mating Retention Type	Locking Lance
-----------------------	---------------

Locking Lance Height	1.4 mm
----------------------	--------

Wire Insulation Support	With
-------------------------	------

### Dimensions

Accepts Wire Insulation Diameter Range	3.43 – 5.08 mm [.135 – .2 in]
--	-------------------------------

Overall Length	29 mm [1.14 in]
----------------	-----------------

Receptacle Terminal Stock Thickness	.41 mm [.016 in]
-------------------------------------	------------------

Wire Size	4 – 6.63 mm <sup>2</sup>
-----------	--------------------------

### Usage Conditions

Insulation Option	Uninsulated
-------------------	-------------

Operating Temperature Range	-40 – 110 °C [-40 – 230 °F]
-----------------------------	-----------------------------

### Industry Standards

UL Flammability Rating	UL 94V-2
------------------------	----------

### Packaging Features

Packaging Quantity	500
--------------------	-----

Packaging Method	Loose Piece/Carton
------------------	--------------------

### Other

Comment	Without Locking Hole
---------	----------------------

### Product Compliance

[For compliance documentation, visit the product page on TE.com>](#)

EU RoHS Directive 2011/65/EU	Compliant
------------------------------	-----------

EU ELV Directive 2000/53/EC	Compliant
-----------------------------	-----------

China RoHS 2 Directive MIIT Order No 32, 2016	No Restricted Materials Above Threshold
---	---

EU REACH Regulation (EC) No. 1907/2006	Current ECHA Candidate List: JUNE 2022 (224) Candidate List Declared Against: JAN 2022 (223) SVHC > Threshold: Not Yet Reviewed
--	--

Halogen Content	Low Halogen - Br, Cl, F, I < 900 ppm per homogenous material. Also BFR/CFR/PVC
-----------------	--

Free

Solder Process Capability

Not applicable for solder process capability

Product Compliance Disclaimer

This information is provided based on reasonable inquiry of our suppliers and represents our current actual knowledge based on the information they provided. This information is subject to change. The part numbers that TE has identified as EU RoHS compliant have a maximum concentration of 0.1% by weight in homogenous materials for lead, hexavalent chromium, mercury, PBB, PBDE, DBP, BBP, DEHP, DIBP, and 0.01% for cadmium, or qualify for an exemption to these limits as defined in the Annexes of Directive 2011/65/EU (RoHS2). Finished electrical and electronic equipment products will be CE marked as required by Directive 2011/65/EU. Components may not be CE marked. Additionally, the part numbers that TE has identified as EU ELV compliant have a maximum concentration of 0.1% by weight in homogenous materials for lead, hexavalent chromium, and mercury, and 0.01% for cadmium, or qualify for an exemption to these limits as defined in the Annexes of Directive 2000/53/EC (ELV). Regarding the REACH Regulation, the information TE provides on SVHC in articles for this part number is based on the latest European Chemicals Agency (ECHA) 'Guidance on requirements for substances in articles' posted at this URL: <https://echa.europa.eu/guidance-documents/guidance-on-reach>

### Compatible Parts



TE Part # 1-1579007-4  
EXTRACTION TOOL



TE Part # 4-1579007-3  
EXTRACTION TOOL KIT



TE Part # 154660-2  
FASTON 250 TAB 22-18 AWG TPBR



TE Part # 928906-2  
FF 110 TAB 20-15 AWG .016 TPPB



TE Part # 641256-1  
BLADE TAB 250 18-14AWG BR LP



TE Part # 180250  
HHHT FSTON/FF 375 POS LOC 250 6-2 ASSY



TE Part # 3-1377175-5  
SMP 0-0180409-2



TE Part # 539751-2  
DIE F6.3FF

### Also in the Series | FASTIN-FASTON 250

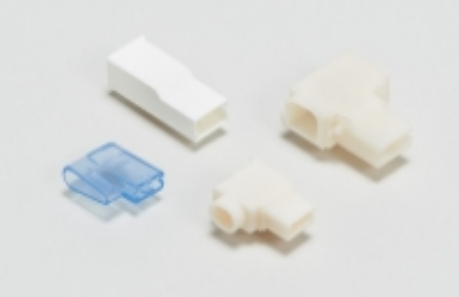

Crimp Terminal Housings(218)



Insertion & Extraction Tools(2)



PCB Terminals(2)



Quick Disconnects(255)

### Customers Also Bought

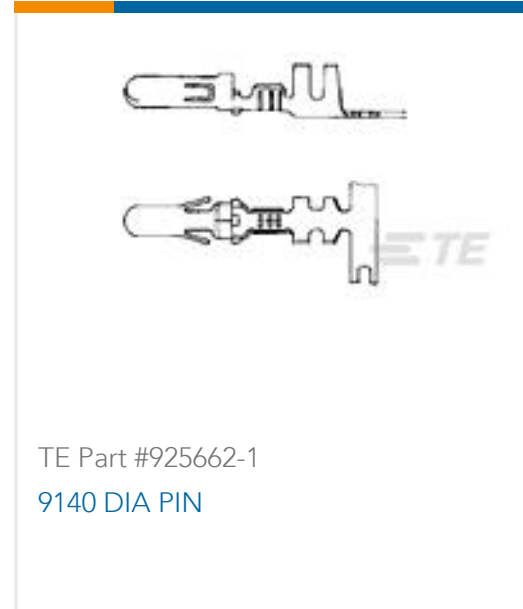
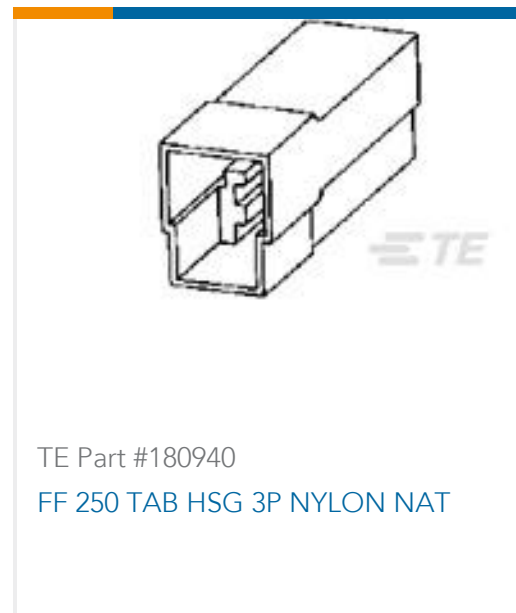

## Documents

### Product Drawings

[FF 250 TAB 4-6MM2 PTBR LP](#)

English

### CAD Files

[3D PDF](#)

3D

Customer View Model

[ENG\\_CVM\\_CVM\\_180409-2\\_F\\_c-180409-2-f.2d\\_dxf.zip](#)

English

Customer View Model

[ENG\\_CVM\\_CVM\\_180409-2\\_F\\_c-180409-2-f.3d\\_igs.zip](#)

English

Customer View Model

[ENG\\_CVM\\_CVM\\_180409-2\\_F\\_c-180409-2-f.3d\\_stp.zip](#)

English

By downloading the CAD file I accept and agree to the [Terms and Conditions](#) of use.

### Datasheets & Catalog Pages



## 1654742\_HOUSEHOLD\_APPLIANCES\_RAST5

English

---

### Product Specifications

FASTIN-FASTON CONN. .110 INCH, .187 INCH, .250 INCH, .375 INCH SRS.

English

### Product Specification

English