



AMP | Multilock Connector System

TE Internal #: 179008-1

Automotive Terminals, Receptacle, Mating Tab Width 1 mm [.039 in], Tab Thickness .025 in [.64 mm], 18 – 16 AWG Wire Size, Multilock Connector System

[View on TE.com >](#)

Terminals & Splices > Automotive Terminals > MULTILOCK, RECEPTACLE AND TAB



Terminal Type: **Receptacle**

Mating Tab Width: **1 mm [.039 in]**

Mating Tab Thickness: **.64 mm [.025 in]**

Terminal Transmits: **0 – 24 A (Low Power)**

Wire Size: **18 – 16 AWG**

[All MULTILOCK, RECEPTACLE AND TAB \(143\)](#)

Features

Product Type Features

Receptacle Style	180°
Sealable	No
Primary Locking Feature	Clean Body

Contact Features

Contact Size	1mm
Contact Fabrication	Stamped & Formed
Crimp Type	F-Crimp
Terminal Type	Receptacle
Mating Tab Width	1 mm [.039 in]
Mating Tab Thickness	.64 mm [.025 in]
Interface Plating	Tin (Sn)
Contact Termination Area Plating Material	Tin (Sn)

Termination Features

Termination Method to Wire & Cable	Crimp
Product Terminates To	Wire

Dimensions

Wire Size	.85 – 1.25 mm ²
-----------	----------------------------



Wire Size Search	16 AWG, 17 AWG, 18 AWG
Wire Insulation Diameter	1.81 – 2.1 mm [.071 – .082 in]

Usage Conditions

Insulation Option	Uninsulated
Operating Temperature (Max)	80 °C, 85 °C, 90 °C, 100 °C, 105 °C [176 °F][185 °F][194 °F][212 °F][221 °F]
Operating Temperature Range	-30 – 105 °C [-22 – 221 °F]

Packaging Features

Packaging Method	Reel
Packaging Quantity	6000

Other

Terminal Transmits	0 – 24 A (Low Power)
--------------------	----------------------

Product Compliance

[For compliance documentation, visit the product page on TE.com>](#)

EU RoHS Directive 2011/65/EU	Compliant
EU ELV Directive 2000/53/EC	Compliant
China RoHS 2 Directive MIIT Order No 32, 2016	No Restricted Materials Above Threshold
EU REACH Regulation (EC) No. 1907/2006	Current ECHA Candidate List: JUNE 2022 (224) Candidate List Declared Against: JAN 2022 (223) SVHC > Threshold: Not Yet Reviewed
Halogen Content	Low Halogen - Br, Cl, F, I < 900 ppm per homogenous material. Also BFR/CFR/PVC Free
Solder Process Capability	Not applicable for solder process capability

Product Compliance Disclaimer

This information is provided based on reasonable inquiry of our suppliers and represents our current actual knowledge based on the information they provided. This information is subject to change. The part numbers that TE has identified as EU RoHS compliant have a maximum concentration of 0.1% by weight in homogenous materials for lead, hexavalent chromium, mercury, PBB, PBDE, DBP, BBP, DEHP, DIBP, and 0.01% for cadmium, or qualify for an exemption to these limits as defined in the Annexes of Directive 2011/65/EU (RoHS2). Finished electrical and electronic equipment products will be CE marked as required by Directive 2011/65/EU. Components may not be CE marked. Additionally, the part numbers that TE has identified as EU ELV compliant have a maximum concentration of 0.1% by weight in homogenous materials for lead, hexavalent chromium, and mercury, and 0.01% for cadmium, or qualify for an exemption to these limits as defined in the Annexes of Directive 2000/53/EC (ELV). Regarding the REACH Regulation, the information TE provides

on SVHC in articles for this part number is based on the latest European Chemicals Agency (ECHA) 'Guidance on requirements for substances in articles' posted at this URL: <https://echa.europa.eu/guidance-documents/guidance-on-reach>

Compatible Parts



TE Part # 2305570-1
TERMINAL CUTTER, SIDE FEED



TE Part # CAT-M9194-CH8172
MULTILOCK, CONNECTOR HOUSING



TE Part # 2-2151178-1
OCEAN_2.0_APPLICATOR-S-080F094F



TE Part # 2-2151178-2
OCEAN_2.0_APPLICATOR-S-080F094FA



TE Part # 2151178-1
OCEAN_2.0_APPLICATOR-S-080F094F



TE Part # 2151178-2
OCEAN_2.0_APPLICATOR-S-080F094FA



TE Part # 7-2151178-1
OCEAN_2.0_APPLICATOR-S-080F094F



TE Part # 7-2151178-2
OCEAN_2.0_APPLICATOR-S-080F094FA



KIT
REPRESENTATION ONLY

TE Part # 7-2151178-7
OCEAN_2.0_SPARE_PART_KIT-080F094F



TE Part # 179620-7
AIR BAG PLUG HSG ASSY 22P

Also in the Series | Multilock Connector System



Automotive Connector Caps & Covers (16)



Automotive Connector EMC Shielding (1)



Automotive Connector Locks & Position Assurance(2)



Automotive Housings(575)



Automotive Seals & Cavity Plugs(2)

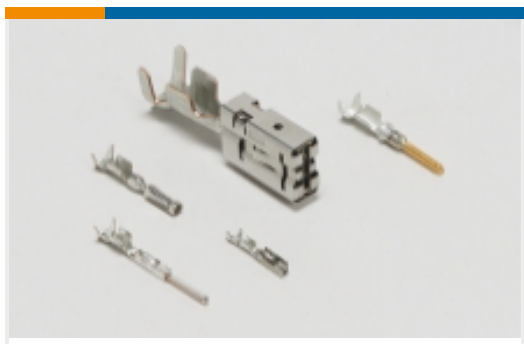

Automotive Terminals(141)



Insertion & Extraction Tools(6)



Other Automotive Connector Accessories(9)

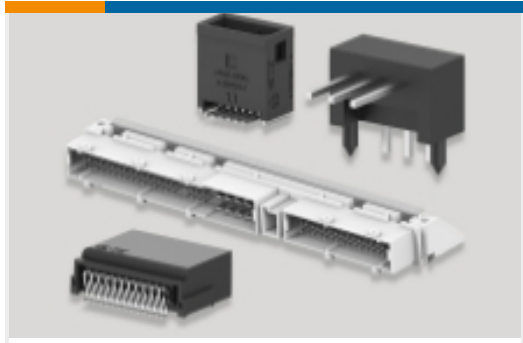

PCB Headers & Receptacles(129)

Customers Also Bought



TE Part #2-1823498-1
62POS, MIXED,REC HSG,ASSY, SEALED



TE Part #1-1564534-1
4POS,TAB 5.8X0.8,TAB HSG,ASSY



TE Part #1488991-5
3POS, MCON 1.2 CB REC 2p TL SEALED

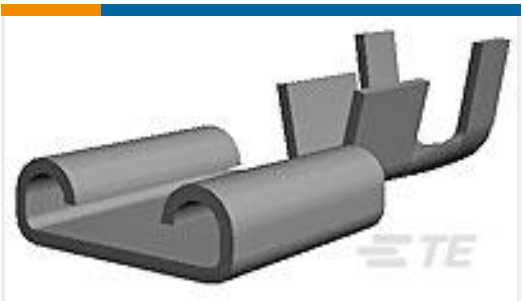

TE Part #3-160256-1
250 FASTON,REC.,17-14 AWG,TPPB

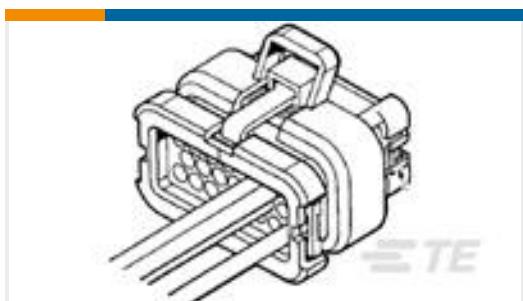

TE Part #776164-2
35POS,AMPSEAL,SOC HSG ASSY,SLD, COD 2

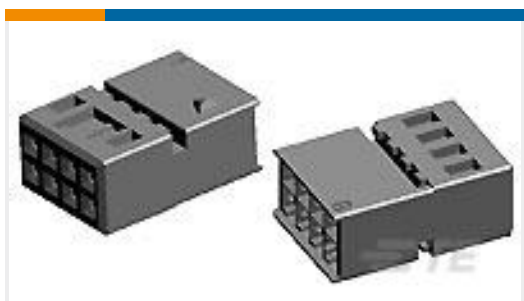

TE Part #965601-2
8POS MQS REC COD II

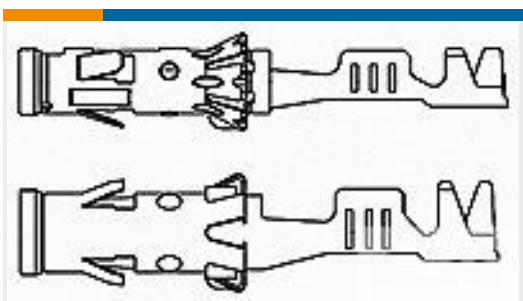

TE Part #1-929974-4
2,5MM SWS REC.CONT.



TE Part #2098634-1
Carrier, 20P, GY LAC, Black



TE Part #2098634-2
Carrier, 20P, GY LAC, Black



TE Part #1393436-2
V23542C1028B102=28P KABELBAUMS

Documents



Product Drawings

040 PMC REC M CONT

English

CAD Files

Customer View Model

[ENG_CVM_179008-1_A1.3d_igs.zip](#)

English

Customer View Model

[ENG_CVM_179008-1_A1.3d_stp.zip](#)

English

Customer View Model

[ENG_CVM_179008-1_A1.2d_dxf.zip](#)

English

3D PDF

English

By downloading the CAD file I accept and agree to the [Terms and Conditions](#) of use.

Datasheets & Catalog Pages

MULTILOCK Connector System

English

Product Specifications

Application Specification

English

Crimping .040II Series Tab and Rec. Contact

English

Product Environmental Compliance

Product Compliance

English

Product Compliance

English