

1924968-1 ✓ ACTIVE

Generation Y Connector System

TE Internal #: 1924968-1

Automotive Terminals, Tab, Mating Tab Width .8 mm [.031 in], Tab Thickness .025 in [.64 mm], 22 – 20 AWG Wire Size, Generation Y Connector System

[View on TE.com >](#)



Terminals & Splices > Automotive Terminals > Generation Y Terminals, 68POS Hybrid



Terminal Type: **Tab**

Mating Tab Width: **.8 mm [.031 in]**

Mating Tab Thickness: **.64 mm [.025 in]**

Terminal Transmits: **0 – 24 A (Low Power)**

Wire Size: **22 – 20 AWG**

[All Generation Y Terminals, 68POS Hybrid \(10\)](#)

Features

Product Type Features

Receptacle Style	180°
Sealable	Yes
Primary Locking Feature	Clean Body

Body Features

Terminal Seal Type	Family Seal
--------------------	-------------

Contact Features

Contact Size	.8mm
Contact Fabrication	Stamped & Formed
Typical Current Rating	9 A
Crimp Type	F-Crimp
Terminal Type	Tab
Mating Tab Width	.8 mm[.031 in]
Mating Tab Thickness	.64 mm[.025 in]
Interface Plating	Tin (Sn)
Contact Termination Area Plating Material	Tin (Sn)

Termination Features

Termination Method to Wire & Cable	Crimp
------------------------------------	-------



Product Terminates To	Wire
-----------------------	------

Dimensions

Wire Size	.35 – .5 mm ²
Wire Size Search	20 AWG, 21 AWG, 22 AWG
Wire Insulation Diameter	1.5 – 1.85 mm [.059 – .073 in]

Usage Conditions

Insulation Option	Uninsulated
Operating Temperature (Max)	80 °C, 85 °C, 90 °C, 100 °C [176 °F][185 °F] [194 °F][212 °F]
Operating Temperature Range	-40 – 100 °C [-40 – 212 °F]

Operation/Application

Compatible With Wire Base Material	Copper
------------------------------------	--------

Industry Standards

Agency/Standard	USCAR-21
-----------------	----------

Packaging Features

Packaging Method	Package
Packaging Quantity	7500

Other

Terminal Transmits	0 – 24 A (Low Power)
--------------------	----------------------

Product Compliance

[For compliance documentation, visit the product page on TE.com>](#)

EU RoHS Directive 2011/65/EU	Compliant
EU ELV Directive 2000/53/EC	Compliant
China RoHS 2 Directive MIIT Order No 32, 2016	No Restricted Materials Above Threshold
EU REACH Regulation (EC) No. 1907/2006	Current ECHA Candidate List: JUNE 2022 (224) Candidate List Declared Against: JUL 2021 (219) SVHC > Threshold: Not Yet Reviewed
Halogen Content	Low Halogen - Br, Cl, F, I < 900 ppm per homogenous material. Also BFR/CFR/PVC Free
Solder Process Capability	Not applicable for solder process capability



Product Compliance Disclaimer

This information is provided based on reasonable inquiry of our suppliers and represents our current actual knowledge based on the information they provided. This information is subject to change. The part numbers that TE has identified as EU RoHS compliant have a maximum concentration of 0.1% by weight in homogenous materials for lead, hexavalent chromium, mercury, PBB, PBDE, DBP, BBP, DEHP, DIBP, and 0.01% for cadmium, or qualify for an exemption to these limits as defined in the Annexes of Directive 2011/65/EU (RoHS2). Finished electrical and electronic equipment products will be CE marked as required by Directive 2011/65/EU. Components may not be CE marked. Additionally, the part numbers that TE has identified as EU ELV compliant have a maximum concentration of 0.1% by weight in homogenous materials for lead, hexavalent chromium, and mercury, and 0.01% for cadmium, or qualify for an exemption to these limits as defined in the Annexes of Directive 2000/53/EC (ELV). Regarding the REACH Regulation, the information TE provides on SVHC in articles for this part number is based on the latest European Chemicals Agency (ECHA) 'Guidance on requirements for substances in articles' posted at this URL: <https://echa.europa.eu/guidance-documents/guidance-on-reach>

Compatible Parts



TE Part # 2138558-1
2P GENERATION Y Cap, Single-Pi



TE Part # CAT-N58-ATHA68
68POS, HYBRID, REC and TAB HSG ASSY



TE Part # 2138558-2
2P GENERATION Y Cap, Single-Pi



TE Part # 2138558-3
2P G-Y Cap, Single-Piece, No Clip, A



TE Part # 2063291-1
PRO-C HT & DIE GEN Y



TE Part # 2203535-1
1X4 GENERATION Y WITH GET INTERFACE



TE Part # 2-2208018-1
22POS, 0.64 MALE GEN. Y, PIN HSG, ASSY



TE Part # 2035306-1
Insert, Jack, Gen Y, Hybrid, FAKRA 4



TE Part # 2141994-1
10POS, TAB 0.63X0.64, PIN HSG, ASSY



TE Part # 2141995-1
10POS, TAB 0.63X0.64, PIN HSG, ASSY



TE Part # 2177614-1
10POS, TAB 0.63X0.64, PIN HSG, C, ASSY



TE Part # 2203535-2
1X4 GENERATION Y WITH GET INTERFACE



TE Part # 2203535-3
1X4 GENERATION Y WITH GET
INTERFACE



TE Part # 2203535-4
1X4 GENERATION Y WITH GET
INTERFACE



TE Part # 2295167-1
22POS,0.64 MALE GEN. Y,TABHSG,
ASSY,SLD



TE Part # 2177615-1
10POS,TAB 0.63X0.64,PIN HSG,D,ASSY



TE Part # 2063291-2
DIE GEN Y

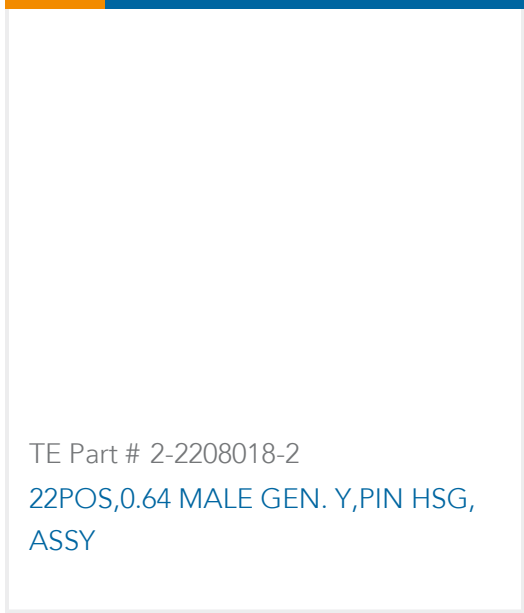

TE Part # 2-2208018-2
22POS,0.64 MALE GEN. Y,PIN HSG,
ASSY

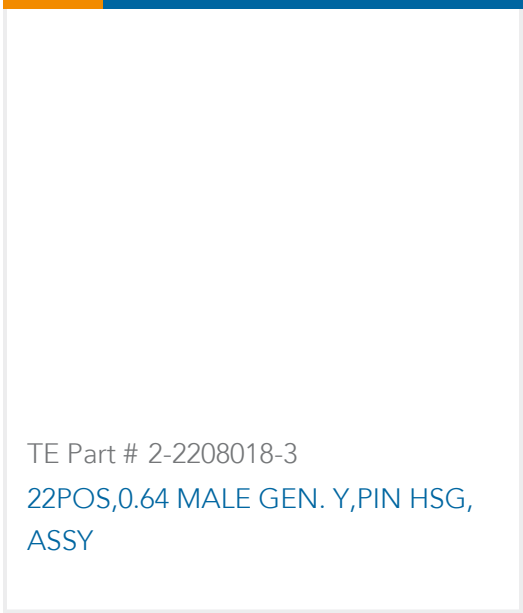

TE Part # 2-2208018-3
22POS,0.64 MALE GEN. Y,PIN HSG,
ASSY

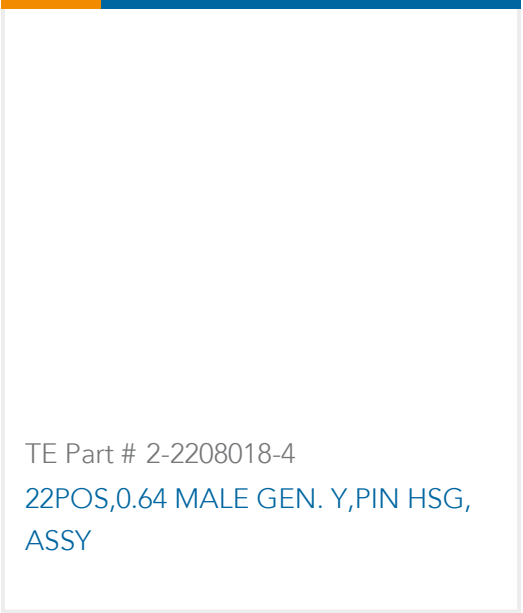

TE Part # 2-2208018-4
22POS,0.64 MALE GEN. Y,PIN HSG,
ASSY

Also in the Series | Generation Y Connector System



Automotive Connector Caps & Covers
(16)



Automotive Housings(153)



Automotive Terminals(39)



Insertion & Extraction Tools(1)



PCB Headers & Receptacles(15)

Customers Also Bought



TE Part #1670144-2
MCON 1.2 CB REC SRC AU



TE Part #1456968-1
CONTACT,FEMALE,0.64, 20 TO 22
AWG, AG



TE Part #1924955-1
CONTACT,FEMALE0.64,20-22AWG,
UNSEAL



TE Part #2138558-1
2P GENERATION Y Cap, Single-Pi

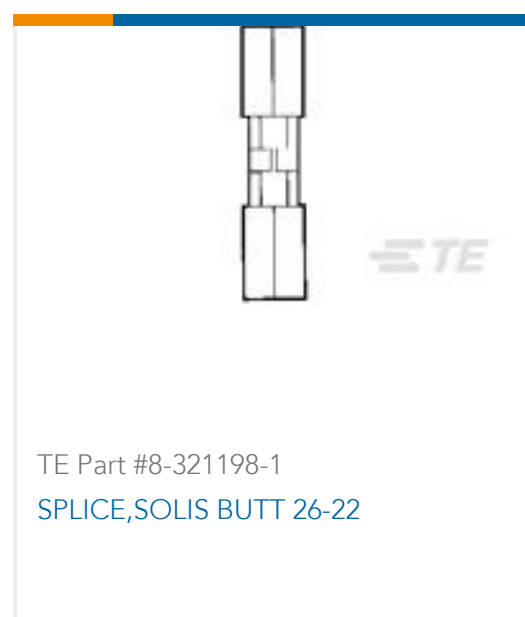

Documents

Product Drawings

[Contact, male 0.64, 20 to 22 AWG](#)

English

CAD Files

Customer View Model

[ENG_CVM_CVM_1924968-1_B.2d_dxf.zip](#)

English

3D PDF

3D

Customer View Model

[ENG_CVM_CVM_1924968-1_B.3d_igs.zip](#)

English

Customer View Model

[ENG_CVM_CVM_1924968-1_B.3d_stp.zip](#)

English

By downloading the CAD file I accept and agree to the [Terms and Conditions](#) of use.

Product Specifications

[Application Specification](#)

English

Product Environmental Compliance

[Product Compliance](#)

English

[Product Compliance](#)

English

1924968-1

Automotive Terminals, Tab, Mating Tab Width .8 mm [.031 in], Tab Thickness .025 in [.64 mm], 22 – 20 AWG Wire Size, Generation Y Connector System

