

1801179-6 ✓ ACTIVE

Sensor Flat Contact System

TE Internal #: 1801179-6

Housing for Female Terminals, Wire-to-Wire, 3 Position, .131 in [3.33 mm] Centerline, Sealable, Brown, Signal, Sensor Flat Contact System

[View on TE.com >](#)



Connectors > Automotive Connectors > Connector Housings



Connector & Housing Type: **Housing for Female Terminals**

Mating Tab Width: .64 mm, 1.5 mm [.025 in, .059 in]

Connector System: **Wire-to-Wire**

Number of Positions: **3**

Centerline (Pitch): **3.33 mm [.131 in]**

Features

Product Type Features

Connector & Housing Shape	Rectangular
Connector & Housing Type	Housing for Female Terminals
Connector System	Wire-to-Wire
Sealable	Yes
Hybrid Connector	No
Primary Locking Feature	Integrated in Housing

Configuration Features

Number of Positions	3
Number of Rows	1

Electrical Characteristics

Operating Voltage	16 VDC
Nominal Voltage Architecture	12 V

Body Features

Cable Exit Angle	180°
------------------	------



Body Material	PBT GF
Primary Product Color	Brown
Connector Code	6

Contact Features

Contact Size	1.5mm
Contact Type	Receptacle
Mating Tab Width	.64 mm, 1.5 mm [.025 in][.059 in]

Mechanical Attachment

Mounting Feature	Without
Terminal Position Assurance	Yes
Strain Relief	Add By Accessory
Mating Alignment Type	Keyed
Mating Alignment	With
Connector Mounting Type	Cable Mount (Free-Hanging)

Housing Features

Centerline (Pitch)	3.33 mm [.131 in]
--------------------	-------------------

Dimensions

Product Width	35.05 mm [1.38 in]
Product Length	21.33 mm [.84 in]
Product Height	21 mm [.827 in]

Usage Conditions

Operating Temperature (Max)	70 °C, 75 °C, 80 °C, 85 °C, 90 °C, 100 °C, 105 °C, 110 °C, 120 °C, 125 °C, 130 °C, 140 °C, 145 °C, 150 °C [158 °F][167 °F][176 °F][185 °F][194 °F][212 °F][221 °F][230 °F][248 °F][257 °F][266 °F][284 °F][293 °F][302 °F]
Operating Temperature Range	-40 – 150 °C [-40 – 302 °F]

Operation/Application

Circuit Application	Signal
---------------------	--------

Industry Standards

Degree of Protection	IP69K
UL Flammability Rating	UL 94HB

Other



Serviceable	Yes
Connector Position Assurance Capable	No

Product Compliance

[For compliance documentation, visit the product page on TE.com>](#)

EU RoHS Directive 2011/65/EU	Compliant
EU ELV Directive 2000/53/EC	Compliant
China RoHS 2 Directive MIIT Order No 32, 2016	No Restricted Materials Above Threshold
EU REACH Regulation (EC) No. 1907/2006	Current ECHA Candidate List: JUNE 2022 (224) Candidate List Declared Against: JAN 2022 (223) SVHC > Threshold: Not Yet Reviewed
Halogen Content	BFR/CFR/PVC Free, but Br/Cl >900 ppm in other sources.
Solder Process Capability	Not applicable for solder process capability

Product Compliance Disclaimer

This information is provided based on reasonable inquiry of our suppliers and represents our current actual knowledge based on the information they provided. This information is subject to change. The part numbers that TE has identified as EU RoHS compliant have a maximum concentration of 0.1% by weight in homogenous materials for lead, hexavalent chromium, mercury, PBB, PBDE, DBP, BBP, DEHP, DIBP, and 0.01% for cadmium, or qualify for an exemption to these limits as defined in the Annexes of Directive 2011/65/EU (RoHS2). Finished electrical and electronic equipment products will be CE marked as required by Directive 2011/65/EU. Components may not be CE marked. Additionally, the part numbers that TE has identified as EU ELV compliant have a maximum concentration of 0.1% by weight in homogenous materials for lead, hexavalent chromium, and mercury, and 0.01% for cadmium, or qualify for an exemption to these limits as defined in the Annexes of Directive 2000/53/EC (ELV). Regarding the REACH Regulation, the information TE provides on SVHC in articles for this part number is based on the latest European Chemicals Agency (ECHA) 'Guidance on requirements for substances in articles' posted at this URL: <https://echa.europa.eu/guidance-documents/guidance-on-reach>

Compatible Parts



TE Part # CAT-AM706-T273
AMP MCP, SFC, RECEPTACLE



TE Part # 1-1579008-0
EXTRACTION TOOL TO OPEN SECONDARY LOCK



TE Part # 1-1801467-1
COVER, FIXED, 3 WAY HP CONNECTOR



TE Part # 1-1801467-2
COVER, FIXED, 3 WAY HP CONNECTOR



Also in the Series | **Sensor Flat Contact System**

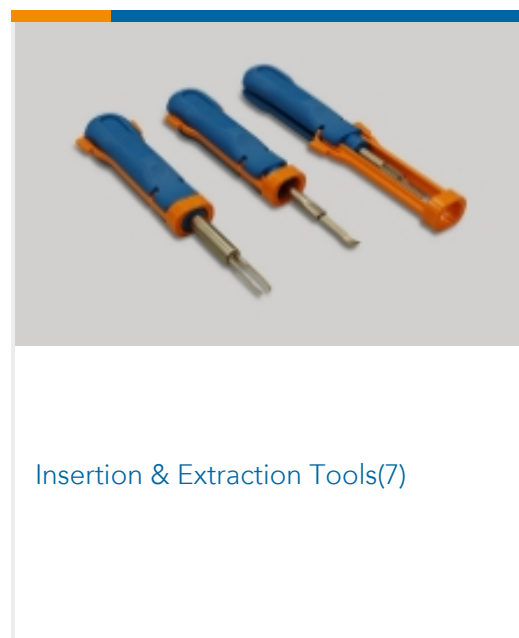
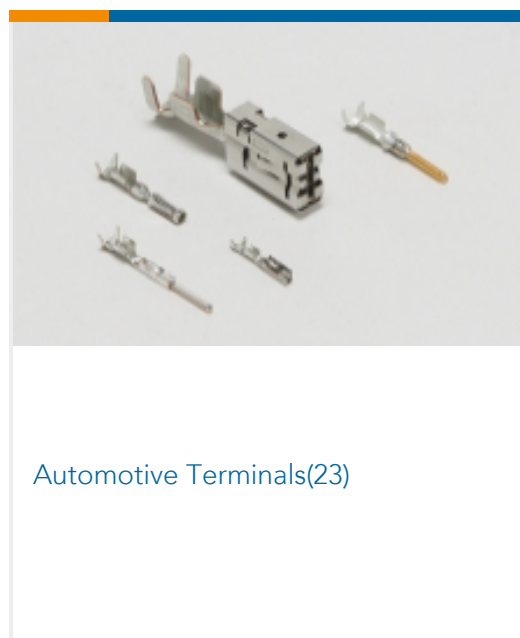
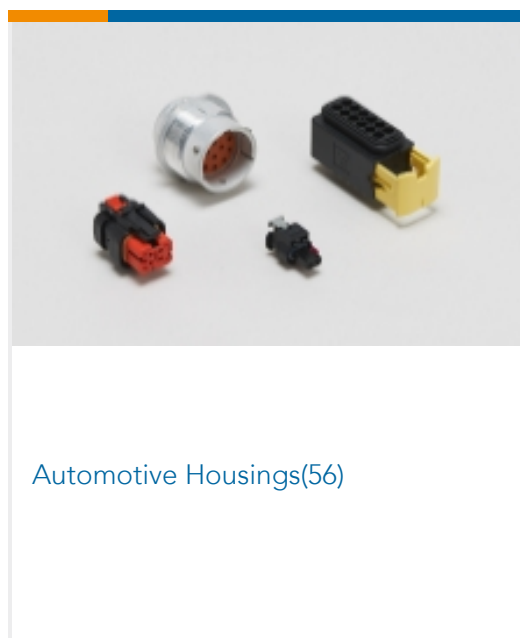
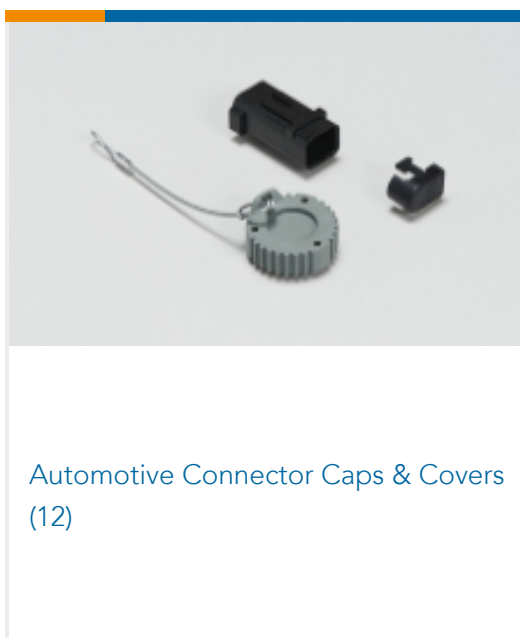

Customers Also Bought

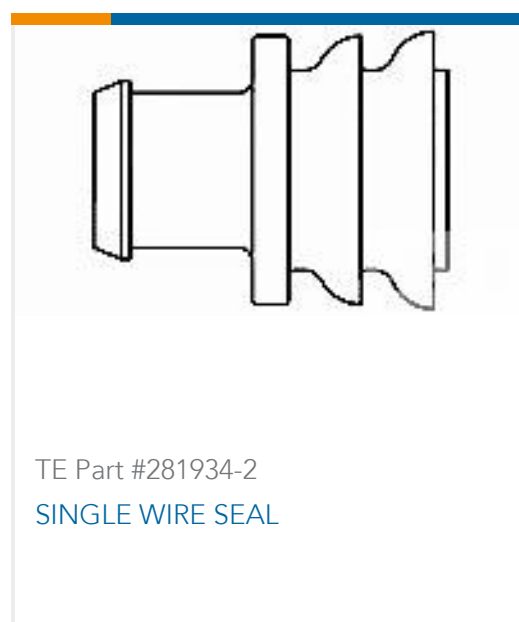
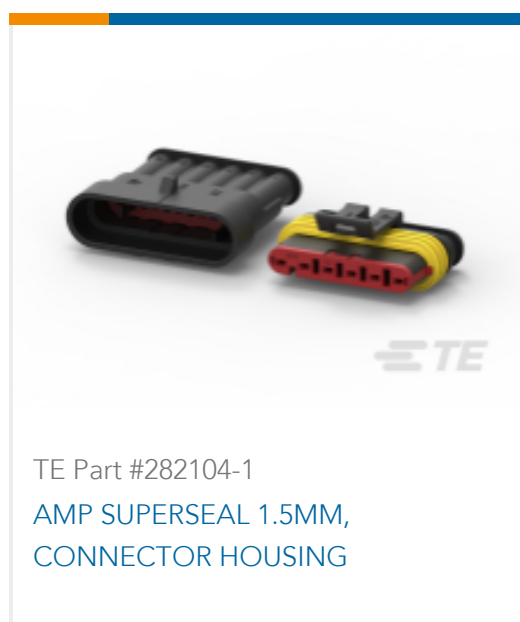
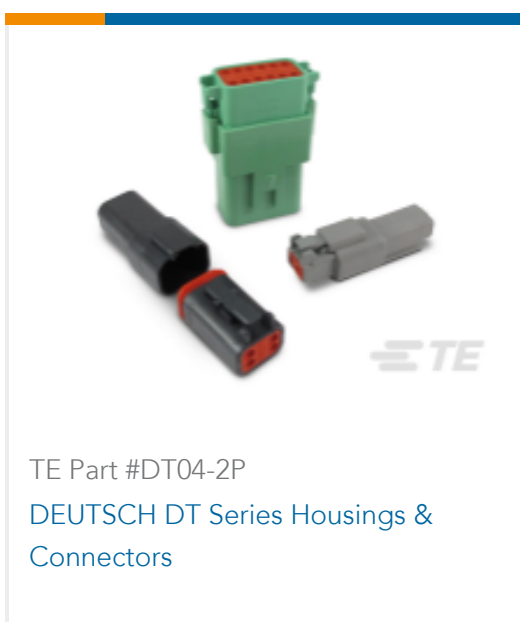



Documents

Product Drawings

[3W RECEPTACLE HPSL CONNECTOR BROWN](#)

English

CAD Files

Customer View Model

[ENG_CVM_CVM_1801179-6_D.2d_dxf.zip](#)

English

[3D PDF](#)

3D

Customer View Model

[ENG_CVM_CVM_1801179-6_D.3d_igs.zip](#)

English

Customer View Model

[ENG_CVM_CVM_1801179-6_D.3d_stp.zip](#)

English

By downloading the CAD file I accept and agree to the [Terms and Conditions](#) of use.

Product Specifications

[Product Specification](#)

English

Instruction Sheets

[Instruction Sheet \(non U.S.\)](#)

English