

179973-6 ✓ ACTIVE

Positive Lock | Positive Lock 250

TE Internal #: 179973-6

Quick Disconnects, Receptacle, 22 – 18 AWG Wire Size, .32 – .82 mm<sup>2</sup> Wire Size, Mating Tab Width .25 in [6.35 mm], Straight, Brass, Positive Lock 250

[View on TE.com >](#)



Terminals & Splices > Quick Disconnects



Quick Disconnect Terminal Type: **Receptacle**

Wire Size: .32 – .82 mm<sup>2</sup>

Mating Tab Width: 6.35 mm [.25 in]

Mating Tab Thickness: .81 mm [.032 in]

## Features

### Product Type Features

Terminates To	Wire & Cable
Wire Stop	No
Wire/Cable Type	Regular Wire
Insertion Force	Low
Sealable	No

### Configuration Features

Connection Capacity	Single
---------------------	--------

### Contact Features

Quick Disconnect Terminal Type	Receptacle
Mating Tab Width	6.35 mm [.25 in]
Mating Tab Thickness	.81 mm [.032 in]
Terminal Orientation	Straight
Contact Base Material	Brass
Terminal Plating Material	Pre-Tin
Crimp Type	F-Crimp



Barrel Type	Open
-------------	------

### Mechanical Attachment

Mating Retention Type	Dimple
Extraction Force	5.9 – 29.4 Newton
Wire Insulation Support	With

### Dimensions

Accepts Wire Insulation Diameter Range	1.5 – 3.1 mm [.059 – .122 in]
Overall Length	21.2 mm [.834 in]
Receptacle Terminal Stock Thickness	.41 mm [.016 in]
Wire Size	.32 – .82 mm <sup>2</sup>

### Usage Conditions

Insulation Option	Uninsulated
Operating Temperature Range	-40 – 110 °C [-40 – 230 °F]

### Industry Standards

UL Rating	Listed
-----------	--------

### Packaging Features

Packaging Quantity	5000
Packaging Method	Strip/Reel

### Product Compliance

[For compliance documentation, visit the product page on TE.com>](#)

EU RoHS Directive 2011/65/EU	Compliant
EU ELV Directive 2000/53/EC	Compliant
China RoHS 2 Directive MIIT Order No 32, 2016	No Restricted Materials Above Threshold
EU REACH Regulation (EC) No. 1907/2006	Current ECHA Candidate List: JUNE 2022 (224) Candidate List Declared Against: JAN 2022 (223) SVHC > Threshold: Not Yet Reviewed
Halogen Content	Low Halogen - Br, Cl, F, I < 900 ppm per homogenous material. Also BFR/CFR/PVC Free
Solder Process Capability	Not applicable for solder process capability

## Product Compliance Disclaimer

This information is provided based on reasonable inquiry of our suppliers and represents our current actual knowledge based on the information they provided. This information is subject to change. The part numbers that TE has identified as EU RoHS compliant have a maximum concentration of 0.1% by weight in homogenous materials for lead, hexavalent chromium, mercury, PBB, PBDE, DBP, BBP, DEHP, DIBP, and 0.01% for cadmium, or qualify for an exemption to these limits as defined in the Annexes of Directive 2011/65/EU (RoHS2). Finished electrical and electronic equipment products will be CE marked as required by Directive 2011/65/EU. Components may not be CE marked. Additionally, the part numbers that TE has identified as EU ELV compliant have a maximum concentration of 0.1% by weight in homogenous materials for lead, hexavalent chromium, and mercury, and 0.01% for cadmium, or qualify for an exemption to these limits as defined in the Annexes of Directive 2000/53/EC (ELV). Regarding the REACH Regulation, the information TE provides on SVHC in articles for this part number is based on the latest European Chemicals Agency (ECHA) 'Guidance on requirements for substances in articles' posted at this URL: <https://echa.europa.eu/guidance-documents/guidance-on-reach>

## Compatible Parts



Also in the Series | **Positive Lock 250**



Automotive Terminals(1)



Crimp Terminal Housings(203)



Insertion & Extraction Tools(3)



Insulation Boots & Sleeves(4)



Quick Disconnects(189)

## Customers Also Bought

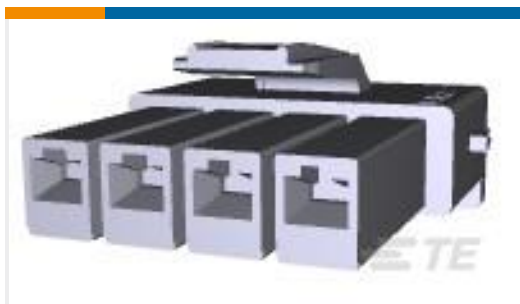

TE Part #316501-6  
POWER D/LOCK PLUG HSG 4P BLUE

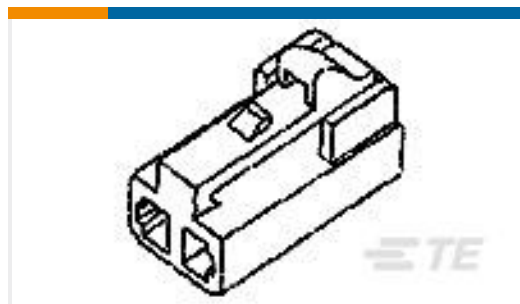

TE Part #172218-1  
FF 250 PLUG HSG 2P NYLON NAT



TE Part #1729339-2  
ANVIL

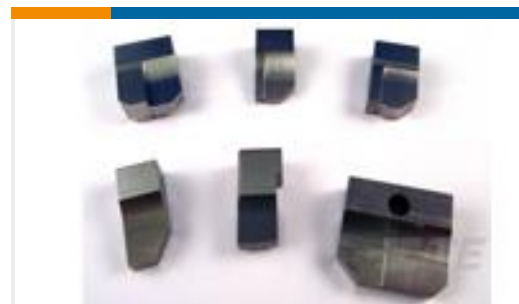

TE Part #1999952-8  
WIRE ANVIL, SIDE FEED 1.4

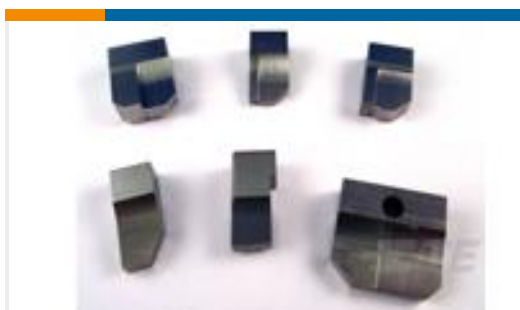

TE Part #2-2047889-4  
ANVIL, INSULATION SF HDE



TE Part #3-1729698-1  
CRIMPER, WIRE (HD-C APPL,  
TERMINAL 16742

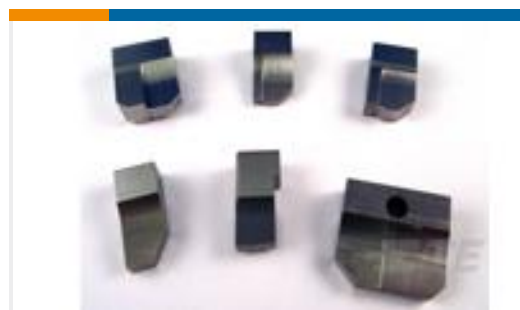

TE Part #4-2047889-3  
ANVIL, INSULATION SF HDE



TE Part #724942-9  
STRIPPER

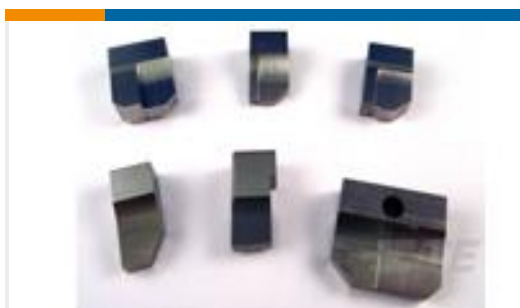

TE Part #8-1762310-9  
WIRE ANVIL, SIDE FEED

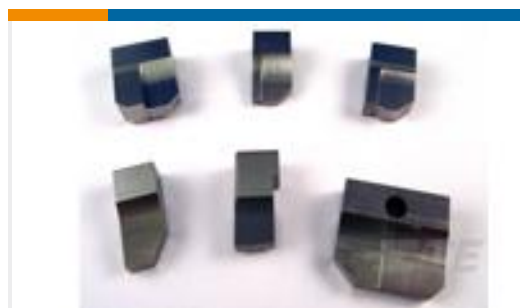

TE Part #9-1729341-5  
COMBINATION ANVIL

## Documents



## Product Drawings

### PL EX 250 REC 22-18 PTPCOPPER-ALLOY

Japanese

---

## CAD Files

### Customer View Model

[ENG\\_CVM\\_CVM\\_179973-6\\_G.2d\\_dxf.zip](#)

English

### 3D PDF

3D

### Customer View Model

[ENG\\_CVM\\_CVM\\_179973-6\\_G.3d\\_igs.zip](#)

English

### Customer View Model

[ENG\\_CVM\\_CVM\\_179973-6\\_G.3d\\_stp.zip](#)

English

By downloading the CAD file I accept and agree to the [Terms and Conditions](#) of use.

---

## Product Specifications

### Application Specification

English

---

## Instruction Sheets

### POSITIVE LOCK EX-II CONNECTORS, INSTRUCTION SHEET

Japanese

### Instruction Sheet (non U.S.)

English