



AMP | Sealed Sensor Connector SSC System

TE Internal #: 184373-1

Automotive Terminals, Receptacle, Mating Tab Width 1.8 mm [.071 in], Tab Thickness .025 in [.64 mm], Sealed Sensor Connector SSC System

[View on TE.com >](#)

Terminals & Splices > Automotive Terminals



Terminal Type: **Receptacle**

Mating Tab Width: **1.8 mm [.071 in]**

Mating Tab Thickness: **.64 mm [.025 in]**

Terminal Transmits: **0 – 24 A (Low Power)**

Wire Size: **22 – 17 AWG**

Features

Product Type Features

Receptacle Style	180°
Sealable	Yes

Body Features

Terminal Seal Type	Single Wire Seal (SWS)
--------------------	------------------------

Contact Features

Contact Size	1.8mm
Contact Fabrication	Stamped & Formed
Typical Current Rating	11 A
Crimp Type	F-Crimp
Terminal Type	Receptacle
Mating Tab Width	1.8 mm[.071 in]
Mating Tab Thickness	.64 mm[.025 in]
Interface Plating	Gold (Au)
Contact Termination Area Plating Material	Gold (Au)

Termination Features

Termination Method to Wire & Cable	Crimp
Product Terminates To	Wire

Dimensions



Wire Size	.3 – 1 mm ²
Wire Size Search	17 AWG, 18 AWG, 19 AWG, 20 AWG, 21 AWG, 22 AWG
Wire Insulation Diameter	1.2 – 2.1 mm [.047 – .082 in]

Usage Conditions

Insulation Option	Uninsulated
Operating Temperature (Max)	80 °C, 85 °C, 90 °C, 100 °C, 105 °C, 110 °C, 120 °C, 125 °C, 130 °C, 140 °C, 145 °C, 150 °C [176 °F][185 °F][194 °F][212 °F][221 °F][230 °F][248 °F][257 °F][266 °F][284 °F][293 °F][302 °F]
Operating Temperature Range	-40 – 150 °C [-40 – 302 °F]

Operation/Application

Compatible With Wire Base Material	Copper
------------------------------------	--------

Packaging Features

Packaging Method	Package
Packaging Quantity	6000

Other

Terminal Transmits	0 – 24 A (Low Power)
--------------------	----------------------

Product Compliance

[For compliance documentation, visit the product page on TE.com>](#)

EU RoHS Directive 2011/65/EU	Compliant
EU ELV Directive 2000/53/EC	Compliant
China RoHS 2 Directive MIIT Order No 32, 2016	No Restricted Materials Above Threshold
EU REACH Regulation (EC) No. 1907/2006	Current ECHA Candidate List: JUNE 2022 (224) Candidate List Declared Against: JAN 2022 (223) SVHC > Threshold: Not Yet Reviewed
Halogen Content	Low Halogen - Br, Cl, F, I < 900 ppm per homogenous material. Also BFR/CFR/PVC Free
Solder Process Capability	Not applicable for solder process capability

Product Compliance Disclaimer

This information is provided based on reasonable inquiry of our suppliers and represents our current actual knowledge based on the information they provided. This information is subject to change. The part numbers that TE has identified as EU RoHS compliant have a maximum concentration of 0.1% by weight in homogenous materials for lead, hexavalent chromium, mercury, PBB, PBDE, DBP, BBP, DEHP, DIBP, and 0.01% for cadmium, or qualify for an exemption to these limits as defined in the Annexes of Directive 2011/65/EU (RoHS2). Finished electrical and electronic equipment products will be CE marked as required by Directive 2011/65/EU. Components may not be CE marked. Additionally, the part numbers that TE has identified as EU ELV compliant have a maximum concentration of 0.1% by weight in homogenous materials for lead, hexavalent chromium, and mercury, and 0.01% for cadmium, or qualify for an exemption to these limits as defined in the Annexes of Directive 2000/53/EC (ELV). Regarding the REACH Regulation, the information TE provides on SVHC in articles for this part number is based on the latest European Chemicals Agency (ECHA) 'Guidance on requirements for substances in articles' posted at this URL: <https://echa.europa.eu/guidance-documents/guidance-on-reach>

Compatible Parts



TE Part # 184006-1
2 POS. PLUG ASSY, KEY D, GREEN



TE Part # 184046-1
4 POS. PLUG ASSY, KEY A

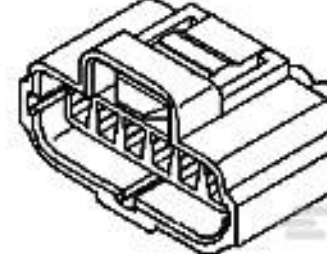

TE Part # 184060-1
6 POS./6 CIRC PLUG ASSY, KEY A



TE Part # 184022-1
2 POS. PLUG ASSY, KEY M, BLACK



TE Part # 184000-1
2 POS. PLUG ASSY, KEY A, BLACK



TE Part # 184032-1
3 POS. PLUG ASSY, KEY A



TE Part # 184115-1
12 POS. PLUG ASSY



TE Part # 184344-1
2X2 PLG ASSY KEY A C3



TE Part # 184006-2
2 POS. PLUG ASSY, KEY D, GRAY



TE Part # 184392-2
2X2 PLG ASSY, KEY A, W/O CPA C3, natural



TE Part # 184248-1
2X2 PLG ASSY KEY A C4



TE Part # 184207-1
2 POS. PLUG ASSY, KEY J



TE Part # 184340-1
PLUG ASSY, 2X2, CPA, W/O SLOT, CKT4 BLKD



TE Part # 184004-1
2 POS. PLUG ASSY, KEY C, BLACK



TE Part # 184042-1
1 POS. PLUG ASSY, KEY A



TE Part # 184012-1
2 POS. PLUG ASSY, KEY G, GRAY



Also in the Series | Sealed Sensor Connector SSC System

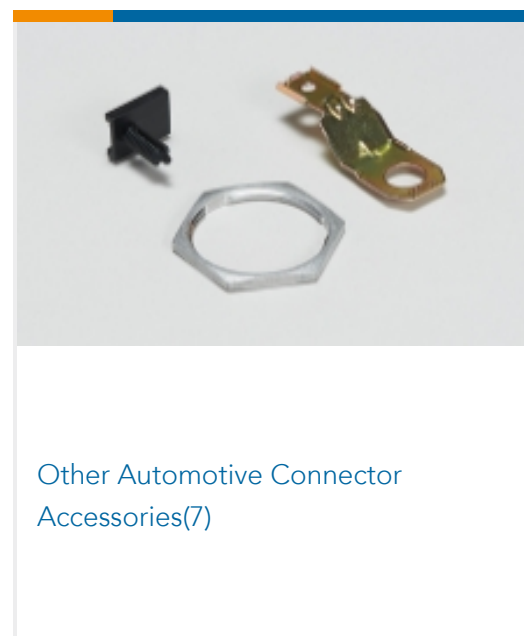
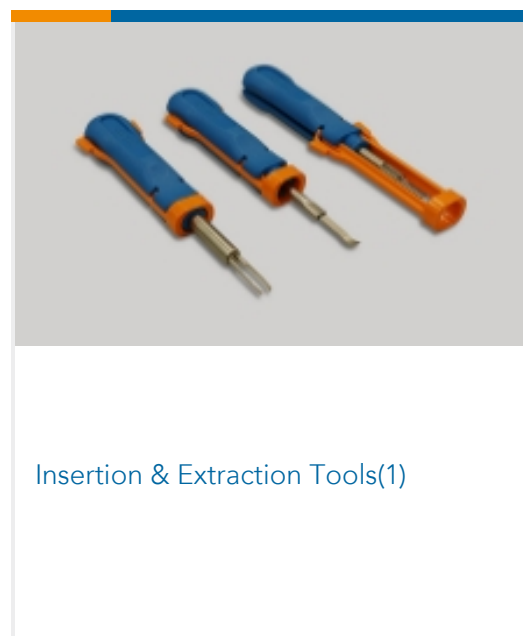
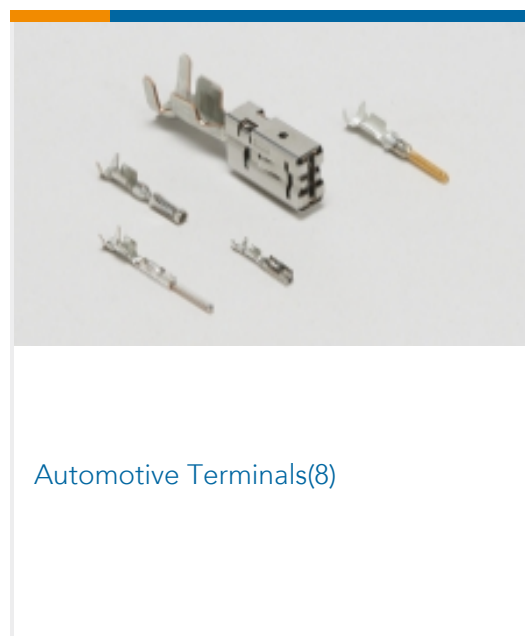
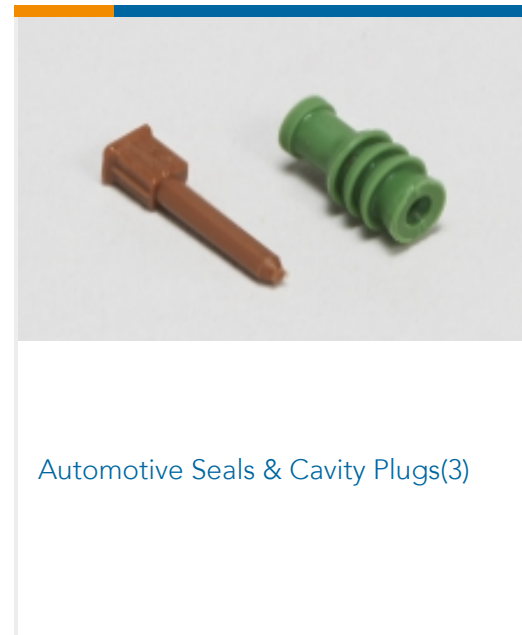
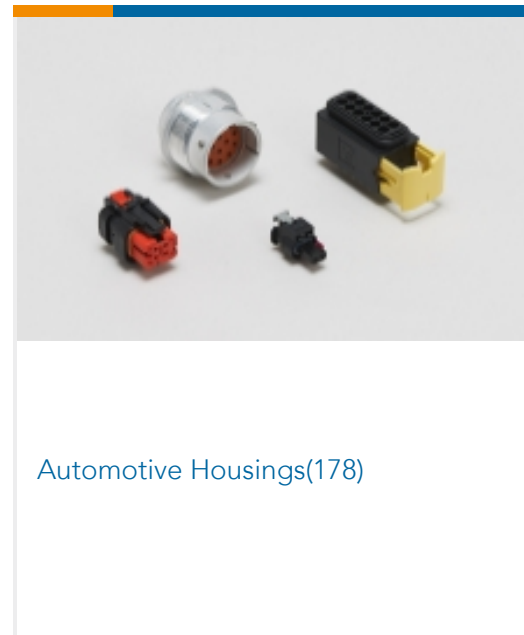
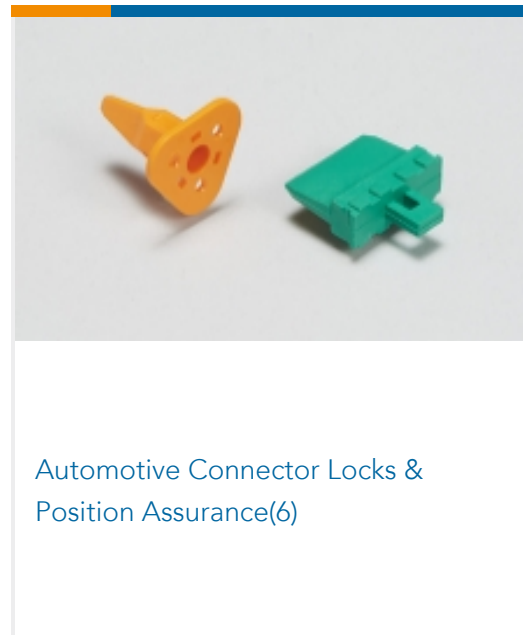
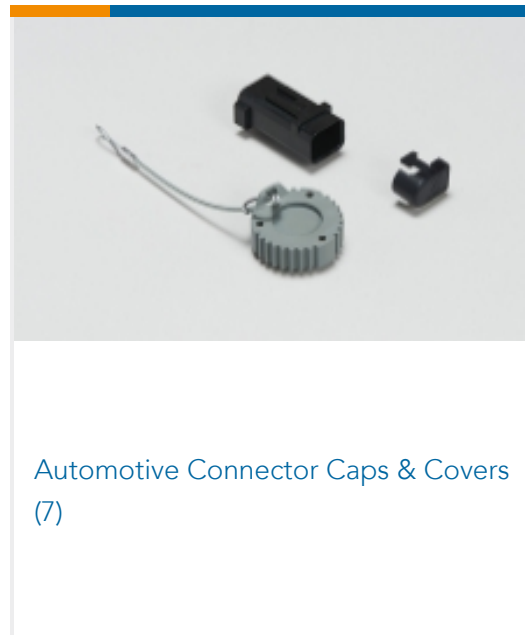

Customers Also Bought

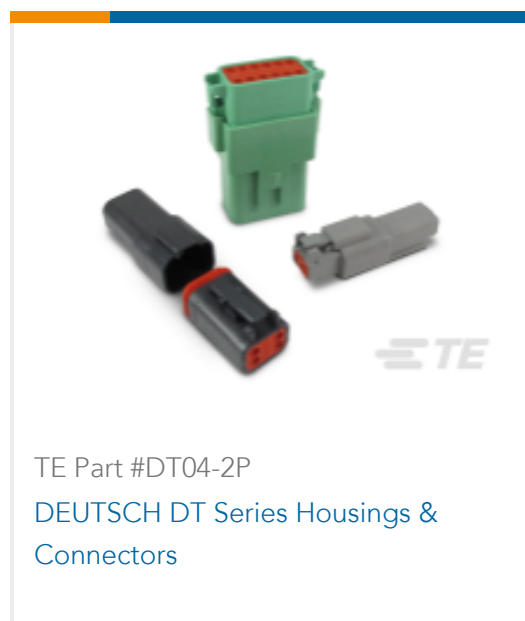



Documents

Product Drawings

[CONTACT, RECEPTACLE, .070 TYPE](#)

English

CAD Files

Customer View Model

[ENG_CVM_184373-1_A1.3d_igs.zip](#)

English

Customer View Model

[ENG_CVM_184373-1_A1.3d_stp.zip](#)

English

Customer View Model

[ENG_CVM_184373-1_A1.2d_dxf.zip](#)

English

[3D PDF](#)

English

By downloading the CAD file I accept and agree to the [Terms and Conditions](#) of use.

Product Specifications

[Application Specification](#)

English