

175150-1 ✓ ACTIVE

AMP Universal Power

TE Internal #: 175150-1

Power Contacts, Contact, 50 VAC / 300 VAC, Pre-Tin, 20 – 16 AWG

Wire Size, .5 – 1.42 mm² Wire Size, Wire-to-Wire, Wire & Cable,

AMP Universal Power

[View on TE.com >](#)



Connectors > Power Connectors > Power Contacts

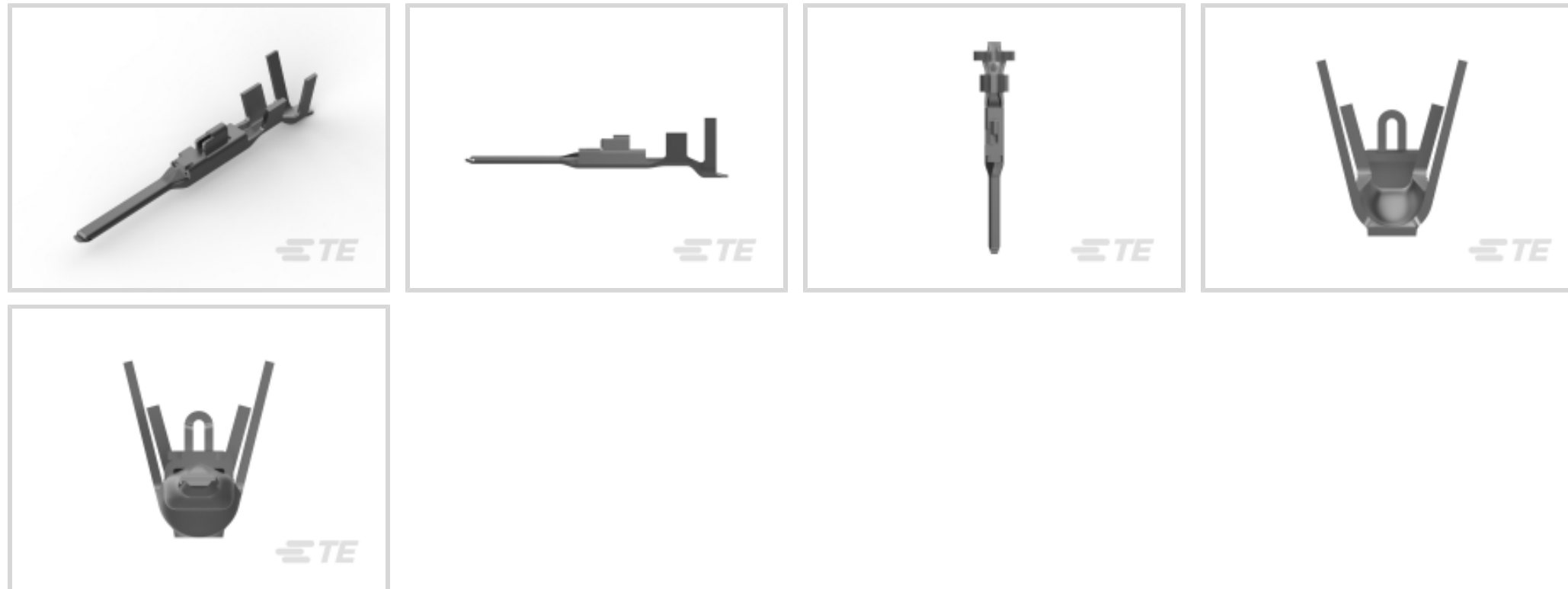

Power Contact Type: **Contact**

Operating Voltage: **50 VAC, 300 VAC**

Contact Mating Area Plating Material: **Pre-Tin**

Wire Size: **.5 – 1.42 mm²**

Features

Product Type Features

Power Contact Type	Contact
Connector System	Wire-to-Wire
Connector & Contact Terminates To	Wire & Cable

Electrical Characteristics

Operating Voltage	50 VAC, 300 VAC
-------------------	-----------------

Contact Features

Contact Mating Area Plating Material	Pre-Tin
Contact Current Rating (Max)	12 A
Contact Type	Tab
Contact Retention Within Housing	With
Mating Tab Width	1.2 mm[.047 in]
Mating Tab Thickness	.64 mm[.025 in]
Contact Base Material	Copper Alloy
Contact Mating Area Plating Material Thickness	.8 μm[31.49 μin]
Wire Contact Termination Area Plating Thickness	.8 μm[31.49 μin]



Wire Contact Termination Area Plating Material	Pre-Tin
Wire Contact Termination Area Plating Material Finish	Matte
Contact Orientation	Straight

Termination Features

Termination Method to Wire & Cable	Crimp
------------------------------------	-------

Mechanical Attachment

Connector Mounting Type	Cable Mount (Free-Hanging)
Wire Insulation Support	Without

Dimensions

Wire Size	.5 – 1.42 mm ²
Accepts Wire Insulation Diameter Range	1.7 – 3.3 mm [.067 – .13 in]

Usage Conditions

Operating Temperature Range	-30 – 105 °C [-22 – 221 °F]
-----------------------------	-----------------------------

Operation/Application

Circuit Application	Power
---------------------	-------

Industry Standards

Glow Wire Rating	Standard Part - Not Glow Wire
------------------	-------------------------------

Packaging Features

Packaging Method	Reel
Packaging Quantity	4000

Product Compliance

For compliance documentation, visit the product page on [TE.com](https://www.te.com)>

EU RoHS Directive 2011/65/EU	Compliant
EU ELV Directive 2000/53/EC	Compliant
China RoHS 2 Directive MIIT Order No 32, 2016	No Restricted Materials Above Threshold
EU REACH Regulation (EC) No. 1907/2006	Current ECHA Candidate List: JUNE 2022 (224) Candidate List Declared Against: JAN 2022 (223) SVHC > Threshold: Not Yet Reviewed
Halogen Content	Low Halogen - Br, Cl, F, I < 900 ppm per homogenous material. Also BFR/CFR/PVC

Free

Solder Process Capability

Not applicable for solder process capability

Product Compliance Disclaimer

This information is provided based on reasonable inquiry of our suppliers and represents our current actual knowledge based on the information they provided. This information is subject to change. The part numbers that TE has identified as EU RoHS compliant have a maximum concentration of 0.1% by weight in homogenous materials for lead, hexavalent chromium, mercury, PBB, PBDE, DBP, BBP, DEHP, DIBP, and 0.01% for cadmium, or qualify for an exemption to these limits as defined in the Annexes of Directive 2011/65/EU (RoHS2). Finished electrical and electronic equipment products will be CE marked as required by Directive 2011/65/EU. Components may not be CE marked. Additionally, the part numbers that TE has identified as EU ELV compliant have a maximum concentration of 0.1% by weight in homogenous materials for lead, hexavalent chromium, and mercury, and 0.01% for cadmium, or qualify for an exemption to these limits as defined in the Annexes of Directive 2000/53/EC (ELV). Regarding the REACH Regulation, the information TE provides on SVHC in articles for this part number is based on the latest European Chemicals Agency (ECHA) 'Guidance on requirements for substances in articles' posted at this URL: <https://echa.europa.eu/guidance-documents/guidance-on-reach>

Compatible Parts



TE Part # 176291-1
UNIV POWER CAP HSG 18P F/H



TE Part # 176299-1
UNVI POWER CAP HSG 12P PNL MTG



TE Part # 176290-1
UNIV POWER CAP HSG 15P F/H



TE Part # 176295-1
UNIV POWER CAP HSG 6P P/MOUNT



TE Part # 176286-1
UNIV POWER CAP HSG 8P F/H



TE Part # 176284-1
AMP UNIVERSAL POWER CAP 4P



TE Part # 176285-1
AMP UNIVERSAL POWER CAP 6P



TE Part # 176285-6
AMP UNIVERSAL POWER CAP 6P

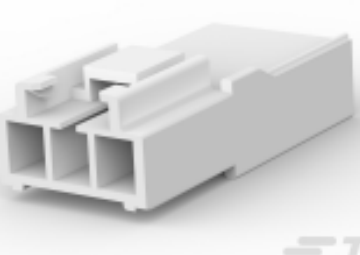

TE Part # 176283-1
AMP UNIVERSA POWR CAP 3P



TE Part # 292180-1
CAP ASS'Y W/O COMMONING TAB FO



TE Part # 176282-4
AMP UNIVERSAL POWER CAP 2P



TE Part # 176282-1
AMP UNIVERSAL POWER CAP 2P





TE Part # 176281-1
UNIV POWER CAP HSG 1P F/H



TE Part # 1-176282-1
AMP UNIVERSAL POWER CAP 2P

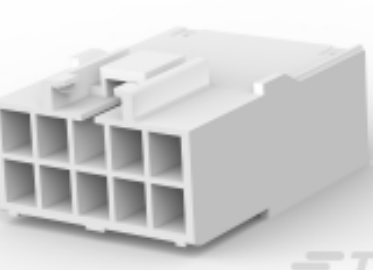

TE Part # 176284-9
AMP UNIVERSAL POWER CAP 4P



TE Part # 176288-1
UNIV POWER CAP HSG 10P F/H



TE Part # 176289-1
UNIV POWER CAP HSG 12P F/H



TE Part # 176297-1
UNIV POWER CAP HSG 9P P/MOUNT



TE Part # 176300-1
UNVI POWER CAP HSG 15P PNL MTG



TE Part # 913923-1
EXTRACTON TOOL FOR 175150

Also in the Series | AMP Universal Power



Connector Contacts(1)



Insertion & Extraction Tools(1)



Power Contacts(21)



Rectangular Power Connectors(177)

Customers Also Bought



TE Part #176291-1
UNIV POWER CAP HSG 18P F/H



TE Part #176284-1
AMP UNIVERSAL POWER CAP 4P

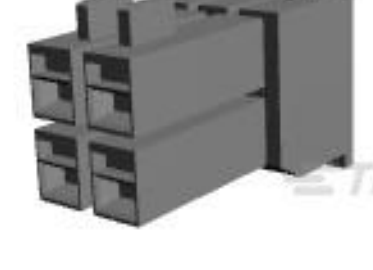

TE Part #176273-1
AMP UNIVERSAL POWR PLUG 4P



TE Part #176272-1
AMP UNIVERSAL POWER PLUG 3P

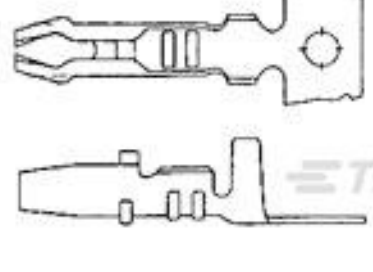

TE Part #170338-1
AMP-IN 22-18 AWG



TE Part #1747050-3
GIC7.92 2POS PLUG HSG.BLUE



TE Part #176277-1
UNIV POWER PLUG HSG 10P F/H



Documents

Product Drawings

UNIVERSAL POWER CONN TAB

English

CAD Files

3D PDF

3D

Customer View Model

[ENG_CVM_CVM_175150-1_L_c-175150-1-l.2d_dxf.zip](#)

English

Customer View Model

[ENG_CVM_CVM_175150-1_L_c-175150-1-l.3d_igs.zip](#)

English

Customer View Model

[ENG_CVM_CVM_175150-1_L_c-175150-1-l.3d_stp.zip](#)

English

By downloading the CAD file I accept and agree to the [Terms and Conditions](#) of use.

Product Specifications

Crimping of Universal Power Contact

English

Product Specification

Japanese

AMP Universal Power Connector

Japanese

AMP Lattice Connector

Japanese

Product Specification

Japanese

AMP UNIVERSAL POWER CONNECTOR M/T TYP

Japanese

Product Specification

Japanese

AMP UNIVERSAL POWER CONNECTOR M/T TYP

English

Product Specification

English

Product Environmental Compliance

MD_175150-1_053120182142_dmtec

English

MD_175150-1_053120182142_dmtec

English



Instruction Sheets

[Extraction Tool for UP\(913923-1\)](#)

English

[Instruction Sheet \(non U.S.\)](#)

English

[AMP UNIVERSAL POWER CONNECTOR SERIES](#)

English

[Instruction Sheet \(non U.S.\)](#)

English

[Hand Tool, PN 914181-1, Universal Power Contact \(Was IS-505J\)](#)

Japanese

[Instruction Sheet \(non U.S.\)](#)

English

Agency Approvals

[UL Report](#)

English