

1924487-3 ✓ ACTIVE

AMP | AMPSEAL 16

TE Internal #: 1924487-3

Other Automotive Connector Accessories, Mounting Clips, Wire-to-Wire, PA, Black, -40 – 125 °C [-40 – 257 °F], AMPSEAL 16

[View on TE.com >](#)



Connectors > Automotive Connectors > Connector Accessories > Other Connector Accessories > AMPSEAL 16 Connectors Mounting Clips

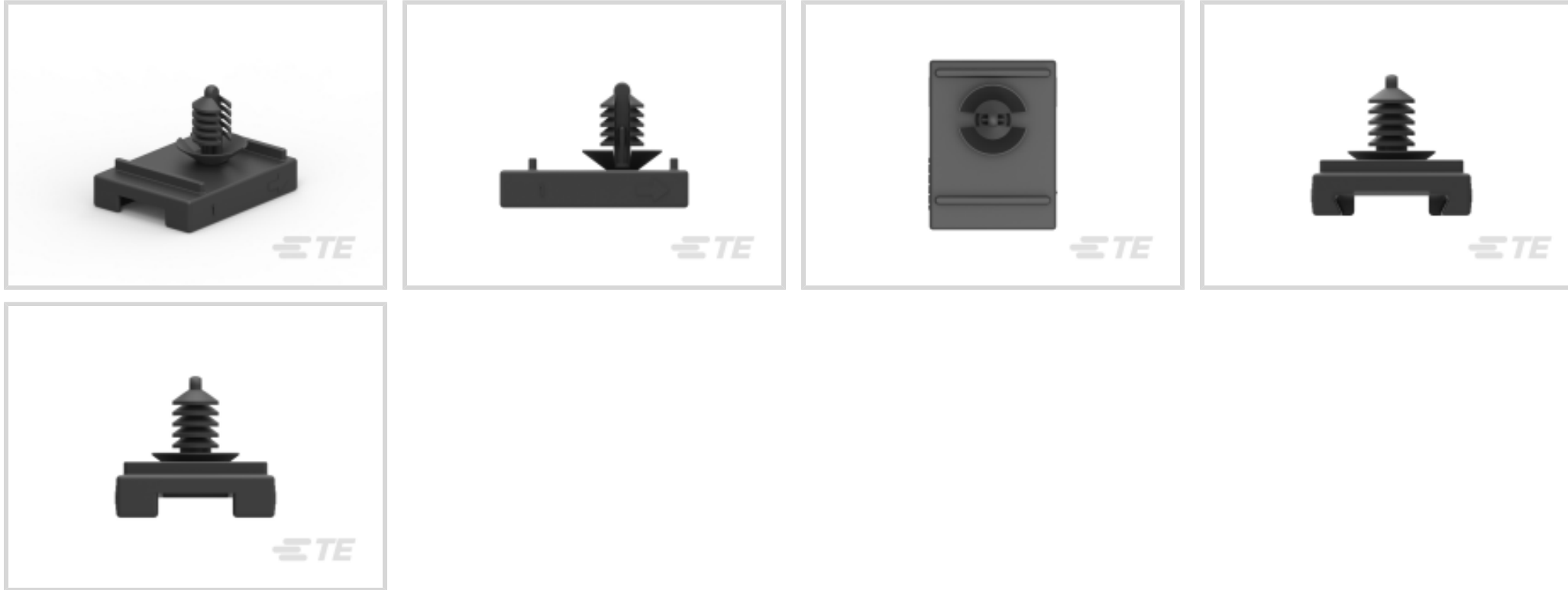

Automotive Connector Accessory Type: **Mounting Clips**

Connector System: **Wire-to-Wire**

Primary Product Material: **PA**

Primary Product Color: **Black**

Operating Temperature Range: **-40 – 125 °C [-40 – 257 °F]**

[All AMPSEAL 16 Connectors Mounting Clips \(3\)](#)

Features

Product Type Features

Automotive Connector Accessory Type	Mounting Clips
Connector System	Wire-to-Wire

Body Features

Primary Product Material	PA
Primary Product Color	Black

Usage Conditions

Operating Temperature Range	-40 – 125 °C[-40 – 257 °F]
-----------------------------	----------------------------

Industry Standards

UL Flammability Rating	UL 94HB
------------------------	---------

Packaging Features

Packaging Quantity	4800
Packaging Method	Box



Other

Serviceable	No
-------------	----

Product Compliance

[For compliance documentation, visit the product page on TE.com>](#)

EU RoHS Directive 2011/65/EU	Compliant
EU ELV Directive 2000/53/EC	Compliant
China RoHS 2 Directive MIIT Order No 32, 2016	No Restricted Materials Above Threshold
EU REACH Regulation (EC) No. 1907/2006	Current ECHA Candidate List: JUNE 2022 (224) Candidate List Declared Against: JAN 2022 (223) SVHC > Threshold: Not Yet Reviewed
Halogen Content	Low Halogen - Br, Cl, F, I < 900 ppm per homogenous material. Also BFR/CFR/PVC Free
Solder Process Capability	Not applicable for solder process capability

Product Compliance Disclaimer

This information is provided based on reasonable inquiry of our suppliers and represents our current actual knowledge based on the information they provided. This information is subject to change. The part numbers that TE has identified as EU RoHS compliant have a maximum concentration of 0.1% by weight in homogenous materials for lead, hexavalent chromium, mercury, PBB, PBDE, DBP, BBP, DEHP, DIBP, and 0.01% for cadmium, or qualify for an exemption to these limits as defined in the Annexes of Directive 2011/65/EU (RoHS2). Finished electrical and electronic equipment products will be CE marked as required by Directive 2011/65/EU. Components may not be CE marked. Additionally, the part numbers that TE has identified as EU ELV compliant have a maximum concentration of 0.1% by weight in homogenous materials for lead, hexavalent chromium, and mercury, and 0.01% for cadmium, or qualify for an exemption to these limits as defined in the Annexes of Directive 2000/53/EC (ELV). Regarding the REACH Regulation, the information TE provides on SVHC in articles for this part number is based on the latest European Chemicals Agency (ECHA) 'Guidance on requirements for substances in articles' posted at this URL: <https://echa.europa.eu/guidance-documents/guidance-on-reach>

Compatible Parts



TE Part # CAT-AM7801-CH8172
AMPSEAL 16 HOUSINGS



TE Part # 2318967-1
24POS,AMP MCP 2.8,REC HSG ASSY, SLD



TE Part # 2319023-1
8POS,AMP MCP 2.8,REC HSG ASSY, SLD



TE Part # 2319023-2
8POS,AMP MCP 2.8,REC HSG ASSY, SLD



TE Part # 2338211-1
CAP PIN ASSY, 4P, W2W, SEALED COAX

TE Part # 2338211-2
CAP PIN ASSY, 4P, W2W, SEALED COAX

TE Part # 2338211-3
CAP PIN ASSY, 4P, W2W, SEALED COAX

TE Part # 2338211-4
CAP PIN ASSY, 4P, W2W, SEALED COAX

Also in the Series | AMPSEAL 16



Automotive Connector Caps & Covers (85)

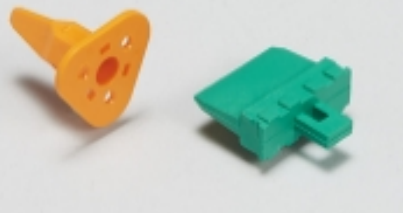

Automotive Connector Locks & Position Assurance(2)



Automotive Housings(241)



Automotive Seals & Cavity Plugs(4)

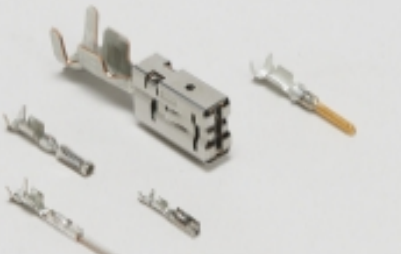

Automotive Terminals(33)



Data Connectivity Housings(3)



Other Automotive Connector Accessories(11)



PCB Headers & Receptacles(3)

Customers Also Bought



TE Part #DT06-3S-C017
DEUTSCH DT Series Housings & Connectors



TE Part #DTM06-6S-EE03
PLG, 6P, BLK, N, XCAP



TE Part #0460-247-1631
PIN, SOLID, SIZE 16, 16-20AWG, EXT, AU



TE Part #776535-1
AS 16, 3P CAP ASSY, RD, KEY 1 AU



TE Part #1060-16-0688
PIN, SF, SIZE 16, 16-20, PD/NI/AU



TE Part #YHDP24-24-19SEL024
DEUTSCH HDP20 HOUSINGS

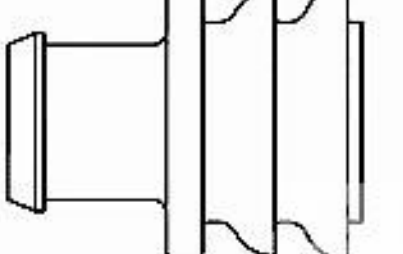

TE Part #282536-1
S.WAY SEAL F.JPT CONTACT 2.5MM



TE Part #11107072-00
AST4400A00100P4Y1000:CTO-13000000-03



Documents

Product Drawings

MOUNTING CLIP, AMPSEAL 16

English

CAD Files

3D PDF

3D

Customer View Model

[ENG_CVM_CVM_1924487-3_D.2d_dxf.zip](#)

English

Customer View Model

[ENG_CVM_CVM_1924487-3_D.3d_igs.zip](#)

English

Customer View Model

[ENG_CVM_CVM_1924487-3_D.3d_stp.zip](#)

English

By downloading the CAD file I accept and agree to the [Terms and Conditions](#) of use.

Product Specifications

Application Specification

English

Product Environmental Compliance

Product Compliance

English

Product Compliance

English