

175785-1 ✓ ACTIVE

Multilock Connector System

TE Internal #: 175785-1

PCB Mount Header, Horizontal, Wire-to-Board, 20 Position, .138 in [3.5 mm] Centerline, Fully Shrouded, Tin (Sn), Multilock Connector System

[View on TE.com >](#)



Connectors > PCB Connectors > PCB Headers & Receptacles > LOW & MEDIUM POWER HEADER



Connector System: **Wire-to-Board**

Number of Positions: **20**

Centerline (Pitch): **3.5 mm [.138 in]**

Sealable: **No**

PCB Mount Orientation: **Horizontal**

[All LOW & MEDIUM POWER HEADER \(153\)](#)

Features

Product Type Features

Hybrid Header	No
Connector & Housing Shape	Rectangular
PCB Connector Assembly Type	PCB Mount Header
Header Type	Fully Shrouded
Connector System	Wire-to-Board
Sealable	No
Connector & Contact Terminates To	Printed Circuit Board

Configuration Features

Number of Sections	1
Number of Signal Positions	20
Number of Positions	20
PCB Mount Orientation	Horizontal
Number of Rows	2



Electrical Characteristics

Voltage Rating (Max)	12 VDC
Nominal Voltage Architecture	12 V
Operating Voltage	12 VDC

Body Features

Primary Product Color	White
-----------------------	-------

Contact Features

Contact Size	1.8mm
Contact Type	Tab
Mating Tab Width	1.8 mm[.071 in]
Mating Tab Thickness	.64 mm[.025 in]
Contact Mating Area Plating Material	Tin (Sn)

Termination Features

Termination Method to Printed Circuit Board	Through Hole - Solder
---	-----------------------

Mechanical Attachment

Mounting Holes	With
Mating Retention	With
Mating Alignment	With
PCB Mount Alignment	Without
Panel Mount Feature	Without
PCB Mount Retention	Without
Mating Retention Type	Locking Interface

Housing Features

Centerline (Pitch)	3.5 mm[.138 in]
--------------------	-----------------

Dimensions

Connector Length	24.92 mm[.981 in]
Connector Width	60.3 mm[2.374 in]
PCB Thickness (Recommended)	1.6 mm[.063 in]
Profile Height from PCB	15.8 mm[.622 in]

Usage Conditions

Operating Temperature (Max)	65 °C, 70 °C, 75 °C, 80 °C, 85 °C, 90 °C, 100 °C, 105 °C[149 °F][158 °F][167 °F][176 °F]
-----------------------------	--



	[185 °F][194 °F][212 °F][221 °F]
Operating Temperature Range	-30 – 105 °C[-22 – 221 °F]

Operation/Application

Shielded	No
Circuit Application	Signal

Industry Standards

UL Flammability Rating	UL 94V-2
------------------------	----------

Packaging Features

Packaging Type	Tube
Packaging Quantity	100

Other

Interface Number	173853
------------------	--------

Product Compliance

[For compliance documentation, visit the product page on TE.com>](#)

EU RoHS Directive 2011/65/EU	Compliant
EU ELV Directive 2000/53/EC	Compliant
China RoHS 2 Directive MIIT Order No 32, 2016	No Restricted Materials Above Threshold
EU REACH Regulation (EC) No. 1907/2006	Current ECHA Candidate List: JUNE 2022 (224) Candidate List Declared Against: JAN 2022 (223) SVHC > Threshold: Not Yet Reviewed
Halogen Content	Not Low Halogen - contains Br or Cl > 900 ppm.
Solder Process Capability	Wave solder capable to 240°C

Product Compliance Disclaimer

This information is provided based on reasonable inquiry of our suppliers and represents our current actual knowledge based on the information they provided. This information is subject to change. The part numbers that TE has identified as EU RoHS compliant have a maximum concentration of 0.1% by weight in homogenous materials for lead, hexavalent chromium, mercury, PBB, PBDE, DBP, BBP, DEHP, DIBP, and 0.01% for cadmium, or qualify for an exemption to these limits as defined in the Annexes of Directive 2011/65/EU (RoHS2). Finished electrical and electronic equipment products will be CE marked as required by Directive 2011/65/EU. Components may not be CE marked. Additionally, the part numbers that TE has identified as EU ELV compliant have a maximum concentration of 0.1% by weight in homogenous materials for lead, hexavalent chromium, and mercury, and 0.01% for cadmium, or qualify for an exemption to these limits as defined in the Annexes of Directive 2000/53/EC (ELV). Regarding the REACH Regulation, the information TE provides on SVHC in articles for this part number is based on the latest European Chemicals Agency (ECHA) 'Guidance on requirements for substances in articles' posted at this URL: <https://echa.europa.eu/guidance-documents/guidance-on-reach>

Compatible Parts



TE Part # CAT-M9194-CH8172
MULTILOCK, CONNECTOR HOUSING

Also in the Series | Multilock Connector System



Automotive Connector Caps & Covers (16)



Automotive Connector EMC Shielding (1)



Automotive Connector Locks & Position Assurance(2)



Automotive Housings(575)



Automotive Seals & Cavity Plugs(2)



Automotive Terminals(141)



Insertion & Extraction Tools(6)

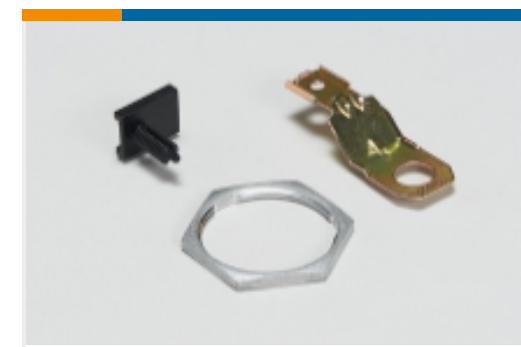

Other Automotive Connector Accessories(9)



PCB Headers & Receptacles(129)

Customers Also Bought

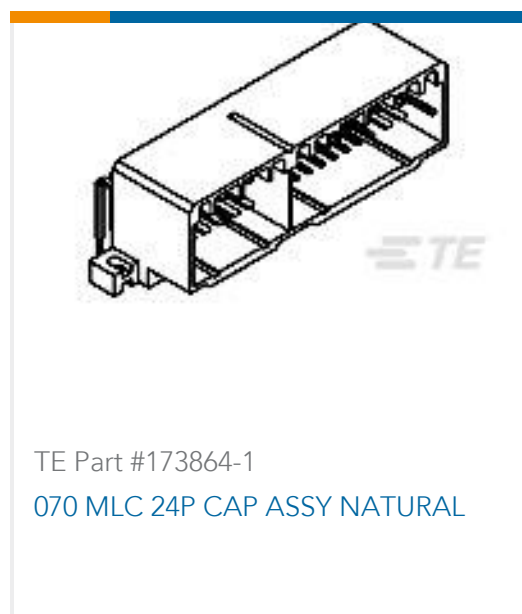

Documents

Product Drawings

070 MLC CAP H ASSY DBL 20P NT.

English

CAD Files

3D PDF

English

Customer View Model

[ENG_CVM_175785-1_D1.2d_dxf.zip](#)

English

Customer View Model

[ENG_CVM_175785-1_D1.3d_igs.zip](#)

English

Customer View Model

[ENG_CVM_175785-1_D1.3d_stp.zip](#)

English

3D PDF

3D

Customer View Model

[ENG_CVM_CVM_175785-1_F.2d_dxf.zip](#)

English

Customer View Model

[ENG_CVM_CVM_175785-1_F.3d_igs.zip](#)

English

Customer View Model

[ENG_CVM_CVM_175785-1_F.3d_stp.zip](#)

English

By downloading the CAD file I accept and agree to the [Terms and Conditions](#) of use.

Product Specifications

Product Specification

Japanese