

181270-3 ✓ ACTIVE

AMPMODU | AMPMODU IV/V

TE Internal #: 181270-3

Connector Contact, Socket, Board-to-Board, 22 – 26 AWG Wire Size, 631.52 – 256.56 CMA Wire Size, .32 – .13 mm² Wire Size, Gold, Reel, AMPMODU IV/V

[View on TE.com >](#)



Connectors > PCB Connectors > Wire-to-Board Connectors > Wire-to-Board Connector Contacts



Contact Type: **Socket**

Connector System: **Board-to-Board**

Wire Size: **.32 – .13 mm²**

Features

Product Type Features

Applied Pressure	Standard
Connector System	Board-to-Board
Connector & Contact Terminates To	Printed Circuit Board

Electrical Characteristics

Termination Resistance	7 mΩ
Operating Voltage	40 VAC

Contact Features

Mating Square Post Dimension	.63 mm[.025 in]
Wire Contact Termination Area Plating Material	Gold Flash
	15 μin
Contact Base Material	Phosphor Bronze
Contact Type	Socket
Contact Mating Area Plating Material	Gold
Contact Current Rating (Max)	3 A

Termination Features

Termination Method to Wire & Cable	Crimp
------------------------------------	-------

Mechanical Attachment

Wire Insulation Support	With
-------------------------	------

Dimensions



Accepts Wire Insulation Diameter Range	.9 – 1.55 mm [.035 – .061 in]
--	-------------------------------

Wire Size	.32 – .13 mm ²
-----------	---------------------------

Usage Conditions

Operating Temperature Range	-40 – 80 °C [-40 – 176 °F]
-----------------------------	----------------------------

Operation/Application

Circuit Application	Signal
---------------------	--------

Packaging Features

Packaging Method	Reel
------------------	------

Product Compliance

[For compliance documentation, visit the product page on TE.com>](#)

EU RoHS Directive 2011/65/EU	Compliant
------------------------------	-----------

EU ELV Directive 2000/53/EC	Compliant
-----------------------------	-----------

China RoHS 2 Directive MIIT Order No 32, 2016	No Restricted Materials Above Threshold
---	---

EU REACH Regulation (EC) No. 1907/2006	Current ECHA Candidate List: JUNE 2022 (224) Candidate List Declared Against: JAN 2021 (211) SVHC > Threshold: Not Yet Reviewed
--	--

Halogen Content	Low Halogen - Br, Cl, F, I < 900 ppm per homogenous material. Also BFR/CFR/PVC Free
-----------------	---

Solder Process Capability	Not applicable for solder process capability
---------------------------	--

Product Compliance Disclaimer

This information is provided based on reasonable inquiry of our suppliers and represents our current actual knowledge based on the information they provided. This information is subject to change. The part numbers that TE has identified as EU RoHS compliant have a maximum concentration of 0.1% by weight in homogenous materials for lead, hexavalent chromium, mercury, PBB, PBDE, DBP, BBP, DEHP, DIBP, and 0.01% for cadmium, or qualify for an exemption to these limits as defined in the Annexes of Directive 2011/65/EU (RoHS2). Finished electrical and electronic equipment products will be CE marked as required by Directive 2011/65/EU. Components may not be CE marked. Additionally, the part numbers that TE has identified as EU ELV compliant have a maximum concentration of 0.1% by weight in homogenous materials for lead, hexavalent chromium, and mercury, and 0.01% for cadmium, or qualify for an exemption to these limits as defined in the Annexes of Directive 2000/53/EC (ELV). Regarding the REACH Regulation, the information TE provides on SVHC in articles for this part number is based on the latest European Chemicals Agency (ECHA) 'Guidance on requirements for substances in articles' posted at this URL: <https://echa.europa.eu/guidance-documents/guidance-on-reach>

Compatible Parts

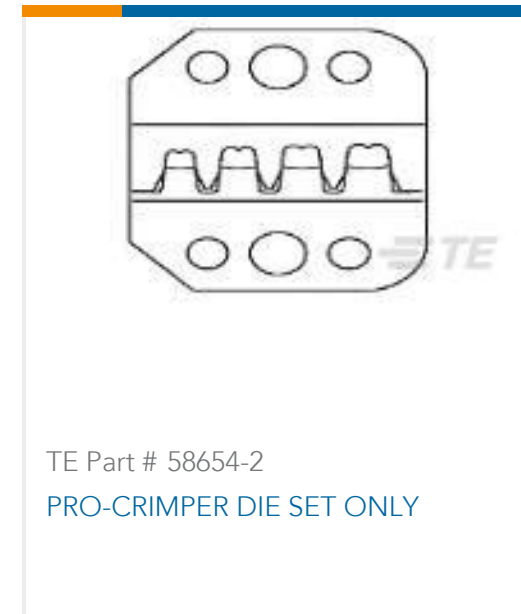
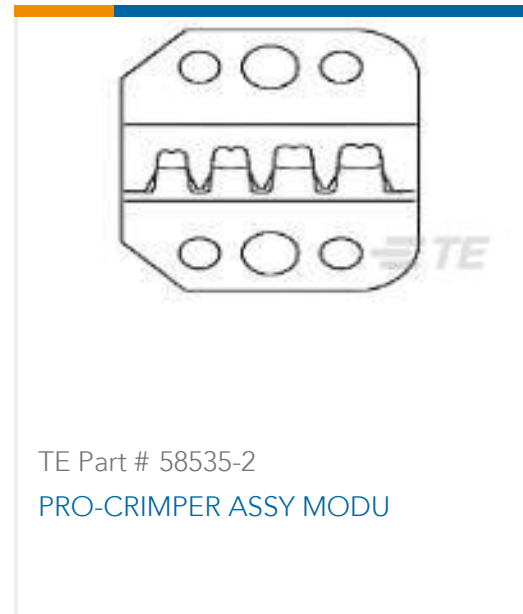
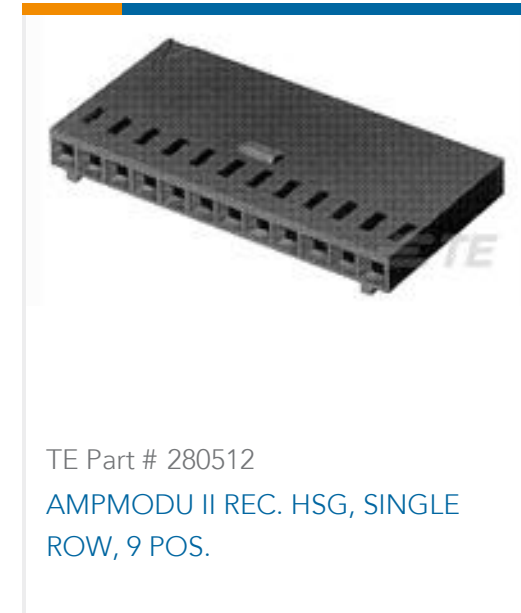
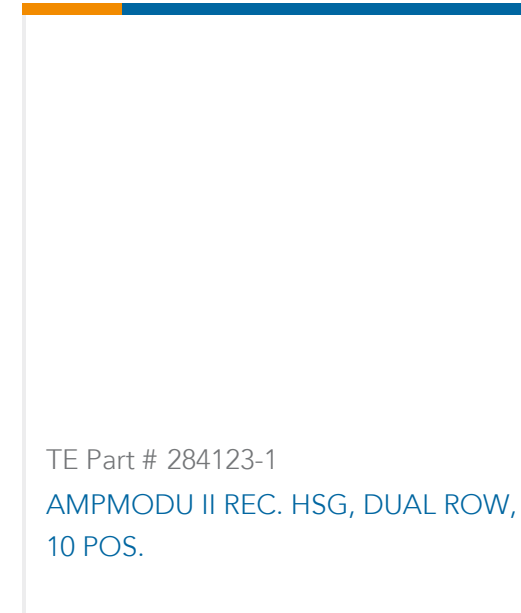

Also in the Series | **AMPMODU IV/V**



Automotive Housings(2)

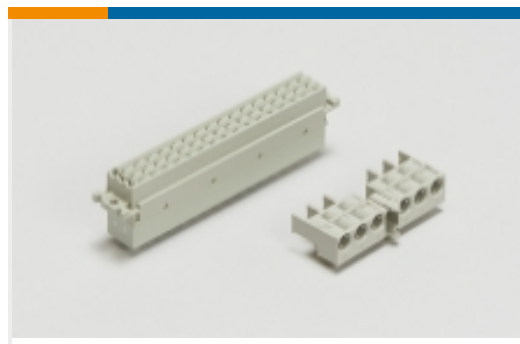

Backplane Connector Housings(1)



Board-to-Board Connector Contacts(6)



Insertion & Extraction Tools(4)

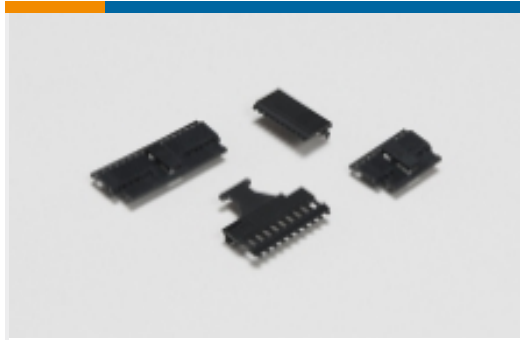

PCB Connector Covers(18)



PCB Connector Keying(6)



PCB Connector Mounting(1)

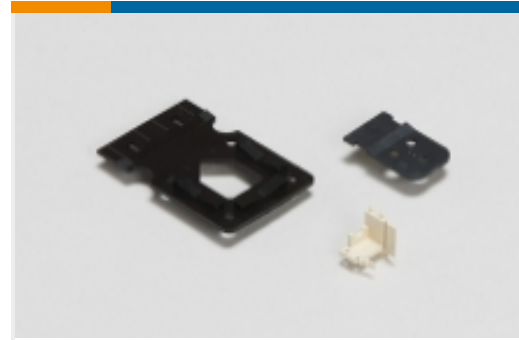

PCB Connector Strain Relief(3)



PCB Headers & Receptacles(939)



PCB Latches, Locks & Retainers(9)



Rectangular Connector Housings(5)



Standard Rectangular Connectors(8)



Wire-to-Board Connector Assemblies & Housings(473)



Wire-to-Board Connector Contacts (328)

Customers Also Bought



TE Part #2-1623788-5
Wirewound Resistor: Vertical Mount



TE Part #964203-1
STD PW TIMER CONTACT



TE Part #5677582005
RNF-3000-9/3-0-STK



TE Part #NB-PTCO-192
Pt1000, 1.2x4.0, Class A, PTFM102A1A0



Documents

Product Drawings

MOD 2 BUCHSE

English

CAD Files

3D PDF

3D

Customer View Model

[ENG_CVM_CVM_181270-3_AN_c-181270-3-an.2d_dxf.zip](#)

English

Customer View Model

[ENG_CVM_CVM_181270-3_AN_c-181270-3-an.3d_igs.zip](#)

English

Customer View Model

[ENG_CVM_CVM_181270-3_AN_c-181270-3-an.3d_stp.zip](#)

English

By downloading the CAD file I accept and agree to the [Terms and Conditions](#) of use.

Product Specifications

Application Specification

English

Product Environmental Compliance

Product Compliance

English

Product Compliance

English