

174804-1 ✓ ACTIVE

MATE-N-LOK | Commercial MATE-N-LOK

TE Internal #: 174804-1

Rectangular Power Connectors, Header, Receptacle, Wire-to-Board, 4 Position, .2 in [5.08 mm] Centerline, Printed Circuit Board, Commercial MATE-N-LOK

[View on TE.com >](#)



Connectors > Power Connectors > Rectangular Power > Rectangular Power Connectors

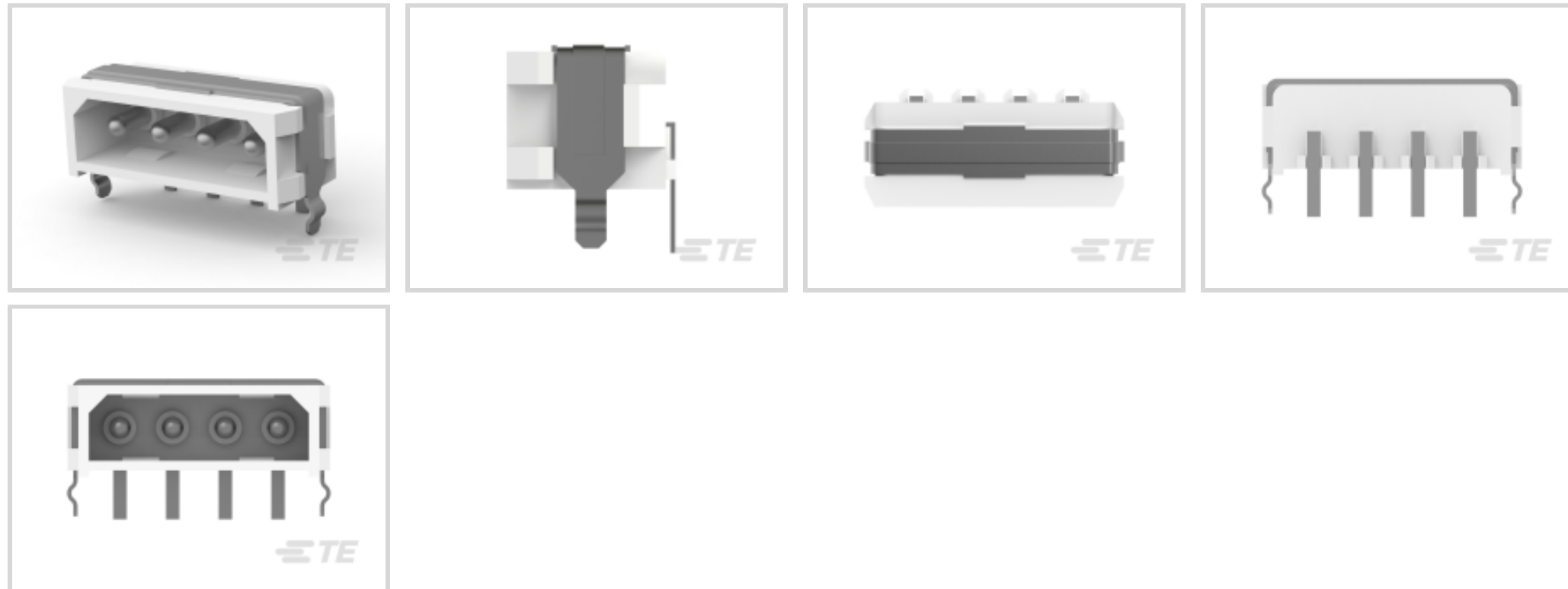

Rectangular Power Connector Type: **Header**

Connector & Housing Type: **Receptacle**

Connector System: **Wire-to-Board**

Number of Positions: **4**

Centerline (Pitch): **5.08 mm [.2 in]**

Features

Product Type Features

Header Type	Fully Shrouded
Rectangular Power Connector Type	Header
Connector & Housing Type	Receptacle
Connector System	Wire-to-Board
Sealable	No
Connector & Contact Terminates To	Printed Circuit Board

Configuration Features

Number of Positions	4
PCB Mount Orientation	Right Angle
Number of Power Positions	4
Number of Rows	1

Electrical Characteristics

Operating Voltage	250 VAC
-------------------	---------

Contact Features



Contact Layout	Inline
Contact Current Rating (Max)	10 A
Contact Retention Within Housing	Without
Contact Type	Pin
PCB Contact Termination Area Plating Material	Tin
Contact Mating Area Plating Material	Tin

Termination Features

Termination Post & Tail Length	4.1 mm[.161 in]
Termination Method to Printed Circuit Board	Through Hole - Solder

Mechanical Attachment

Mating Alignment Type	Polarization
Mating Alignment	With
PCB Mount Retention	With
PCB Mount Retention Type	Fixed Belt
Connector Mounting Type	Board Mount
Mating Retention	With
Mating Retention Type	Detent Lock

Housing Features

Centerline (Pitch)	5.08 mm[.2 in]
Housing Color	Natural
Housing Material	Nylon 66

Dimensions

Width	11.5 mm
PCB Thickness (Recommended)	.06 mm[1.6 in]
Height	13 mm
Length	25.3 mm

Usage Conditions

Operating Temperature Range	-20 – 105 °C[-4 – 221 °F]
-----------------------------	---------------------------

Operation/Application

Circuit Application	Power
---------------------	-------

Industry Standards

UL Flammability Rating	UL 94V-2
------------------------	----------



Glow Wire Rating	Standard Part - Not Glow Wire
Agency/Standard Number	E28476
Agency/Standard	CSA, UL
UL Rating	Certified, Recognized
CSA File Number	LR7189A
VDE Tested	No

Packaging Features

Packaging Method	Bag
Packaging Quantity	200

Other

For Use With	Socket (Plug) Housing
--------------	-----------------------

Product Compliance

[For compliance documentation, visit the product page on TE.com>](#)

EU RoHS Directive 2011/65/EU	Compliant
EU ELV Directive 2000/53/EC	Compliant
China RoHS 2 Directive MIIT Order No 32, 2016	No Restricted Materials Above Threshold
EU REACH Regulation (EC) No. 1907/2006	Current ECHA Candidate List: JUNE 2022 (224) Candidate List Declared Against: JAN 2022 (223) SVHC > Threshold: Not Yet Reviewed
Halogen Content	Low Halogen - Br, Cl, F, I < 900 ppm per homogenous material. Also BFR/CFR/PVC Free
Solder Process Capability	Wave solder capable to 265°C

Product Compliance Disclaimer

This information is provided based on reasonable inquiry of our suppliers and represents our current actual knowledge based on the information they provided. This information is subject to change. The part numbers that TE has identified as EU RoHS compliant have a maximum concentration of 0.1% by weight in homogenous materials for lead, hexavalent chromium, mercury, PBB, PBDE, DBP, BBP, DEHP, DIBP, and 0.01% for cadmium, or qualify for an exemption to these limits as defined in the Annexes of Directive 2011/65/EU (RoHS2). Finished electrical and electronic equipment products will be CE marked as required by Directive 2011/65/EU. Components may not be CE marked. Additionally, the part numbers that TE has identified as EU ELV compliant have a maximum concentration of 0.1% by weight in homogenous materials for lead, hexavalent chromium, and mercury, and 0.01% for cadmium, or qualify for an exemption to these limits as defined in the Annexes of Directive 2000/53/EC (ELV). Regarding the REACH Regulation, the information TE provides on SVHC in articles for this part number is based on the latest European Chemicals Agency (ECHA) 'Guidance on requirements for substances in articles' posted at this URL: <https://echa.europa.eu/guidance-documents/guidance-on-reach>

Compatible Parts



TE Part # 794287-1
04P CMNL HDR ASSY BLK HT



TE Part # 1-480424-0
04P CMNL PLUG HSG F/H NATL



TE Part # 770997-1
04P CMNL SOK HDR ASSY



TE Part # 1-480424-9
04P CMNL PLUG HSG F/H BLK



TE Part # 770156-4
4P CMNL IDC PLUG 20AWG YEL V2



TE Part # 770156-5
04P CMNL IDC PLUG 16 AWG BLU V



TE Part # 827001-2
4P MNL STIFTSOCKEL



TE Part # 172349-1
4P C-M-N-L HEADER ASSY H



TE Part # 770156-3
4P CMNL IDC PLUG 18AWG ORG V2



TE Part # 770156-2
4P CMNL IDC PLUG 22AWG RED V2

Also in the Series | Commercial MATE-N-LOK



Connector Contacts(26)



Crimp Wire Pins, Tabs & Ferrules(3)



Insertion & Extraction Tools(5)



Power Contacts(129)



Rectangular Caps & Covers(2)



Rectangular Connector Housings(17)

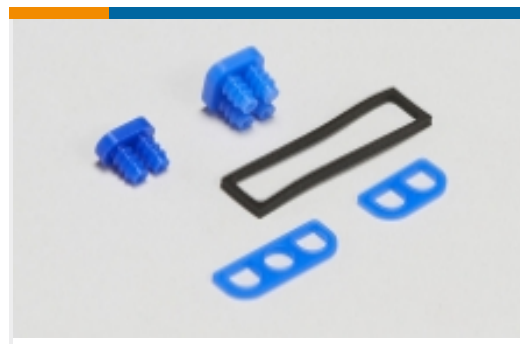

Rectangular Connector Seals(1)



Rectangular Power Connectors(170)



Standard Circular Connectors(4)



Standard Rectangular Connectors(10)



Wire-to-Board Connector Contacts(1)

Customers Also Bought



TE Part #5499913-9
AMP-LATCH UNIVERSAL HEADERS



TE Part #1-353080-2
DYNAMIC D-5200 HDR V ASSY 2P

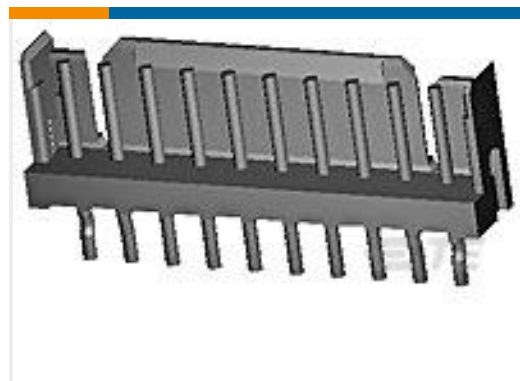

TE Part #1-292161-0
CT P/HDR ASSY V 10P W/KINK NAT

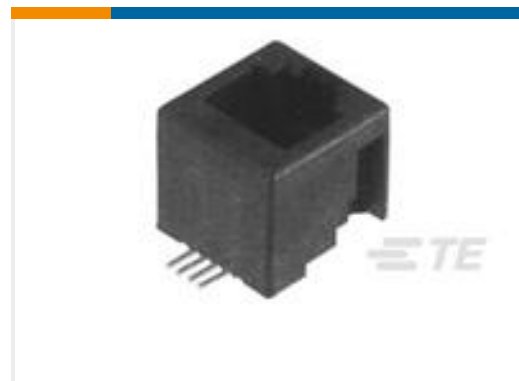

TE Part #1-338088-3
8/8 INV.MOD.JACK



TE Part #1986711-2
SCREWLESS, SW,2P,5.0 PCB



TE Part #9-146282-0
40 MODII HDR SRST B/A .100CL



TE Part #5-102617-1
06 MODII HDR DRRR SHRD LF



TE Part #170148-2
MNL SOCKET L.P. 170147



TE Part #172960-6

Documents



CAD Files

3D PDF

3D

Customer View Model

[ENG_CVM_CVM_174804-1_F.2d_dxf.zip](#)

English

Customer View Model

[ENG_CVM_CVM_174804-1_F.3d_igs.zip](#)

English

Customer View Model

[ENG_CVM_CVM_174804-1_F.3d_stp.zip](#)

English

3D PDF

English

Customer View Model

[ENG_CVM_174804-1_D.2d_dxf.zip](#)

English

Customer View Model

[ENG_CVM_174804-1_D.3d_igs.zip](#)

English

Customer View Model

[ENG_CVM_174804-1_D.3d_stp.zip](#)

English

By downloading the CAD file I accept and agree to the [Terms and Conditions](#) of use.

Datasheets & Catalog Pages

[SOFT_SHELL_PIN_SOCKET_CONNECTORS_STANDARD_DENSITY](#)

English

Product Specifications

[Product Specification](#)

English

[AMP Commercial MATE-N-LOK* Pin Header Assembly](#)

English

Product Environmental Compliance

[MD_174804-1_12182017144_dmtec](#)

English

[MD_174804-1_12182017144_dmtec](#)

English

Agency Approvals

[Agency Approval Document](#)

English