

1743206-1 ✓ ACTIVE

[Positive Lock](#) | [Positive Lock 250](#)

TE Internal #: 1743206-1

Crimp Terminal Housings, Receptacle, Receptacle, 2 Position, Flag,
UL 94V-0, Natural, Nylon, Contact Mating Retention, Positive Lock
250

[View on TE.com >](#)



Terminals & Splices > Terminal Housings, Insulation Sleeves & Blocks > Crimp Terminal Housings

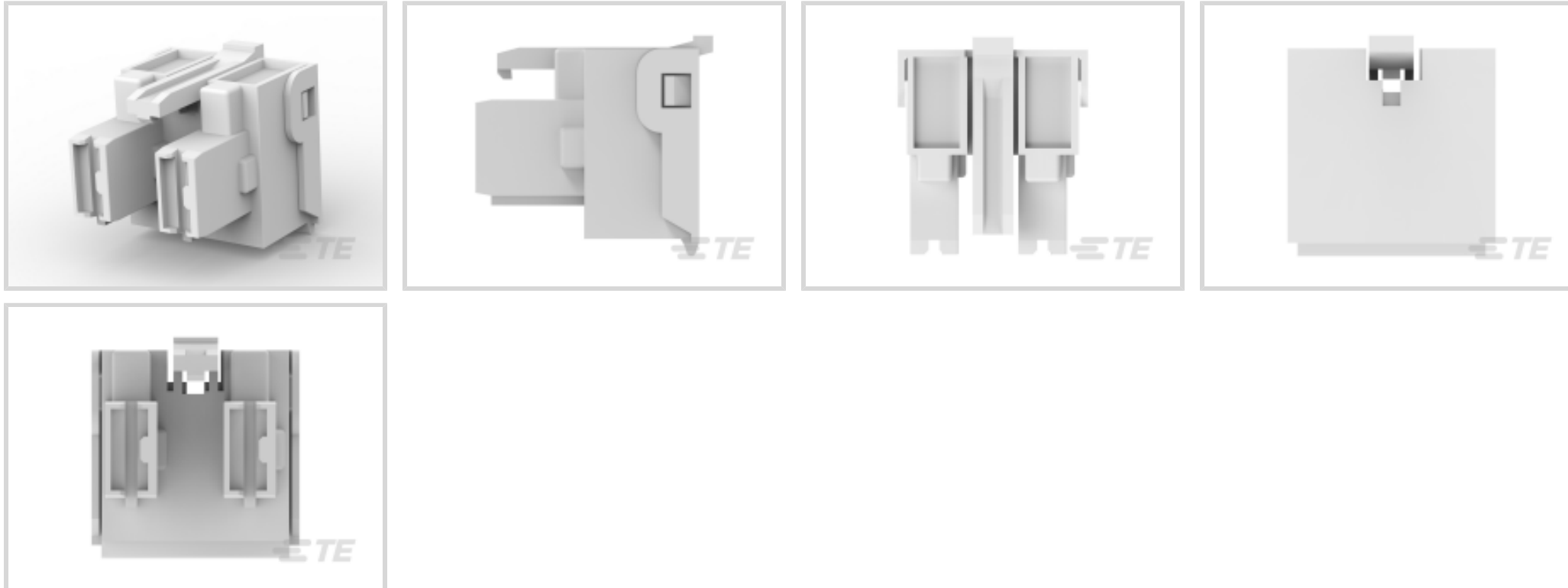

Terminal Type: **Receptacle**

Housing Type: **Receptacle**

Number of Positions: **2**

Terminal Orientation: **Flag**

UL Flammability Rating: **UL 94V-0**

Features

Product Type Features

Product Type	Terminal Housing
Sealable	No
Housing Type	Receptacle
Insulated	No

Configuration Features

Number of Positions	2
---------------------	---

Body Features

Primary Product Color	Natural
-----------------------	---------

Contact Features

Terminal Type	Receptacle
Terminal Orientation	Flag
Contact Mating Retention	With

Mechanical Attachment



Mating Alignment	With
Crimp Terminal Housing Mounting Style	Cable Mount (Free-Hanging)

Housing Features

Housing Material	Nylon
Centerline (Pitch)	12 mm[.472 in]

Usage Conditions

Operating Temperature Range	-40 – 105 °C[-40 – 221 °F]
-----------------------------	----------------------------

Industry Standards

UL Flammability Rating	UL 94V-0
------------------------	----------

Product Compliance

[For compliance documentation, visit the product page on TE.com>](#)

EU RoHS Directive 2011/65/EU	Compliant
EU ELV Directive 2000/53/EC	Compliant
China RoHS 2 Directive MIIT Order No 32, 2016	No Restricted Materials Above Threshold
EU REACH Regulation (EC) No. 1907/2006	Current ECHA Candidate List: JUNE 2022 (224) Candidate List Declared Against: JAN 2022 (223) SVHC > Threshold: Not Yet Reviewed
Halogen Content	Low Halogen - Br, Cl, F, I < 900 ppm per homogenous material. Also BFR/CFR/PVC Free
Solder Process Capability	Not applicable for solder process capability

Product Compliance Disclaimer

This information is provided based on reasonable inquiry of our suppliers and represents our current actual knowledge based on the information they provided. This information is subject to change. The part numbers that TE has identified as EU RoHS compliant have a maximum concentration of 0.1% by weight in homogenous materials for lead, hexavalent chromium, mercury, PBB, PBDE, DBP, BBP, DEHP, DIBP, and 0.01% for cadmium, or qualify for an exemption to these limits as defined in the Annexes of Directive 2011/65/EU (RoHS2). Finished electrical and electronic equipment products will be CE marked as required by Directive 2011/65/EU. Components may not be CE marked. Additionally, the part numbers that TE has identified as EU ELV compliant have a maximum concentration of 0.1% by weight in homogenous materials for lead, hexavalent chromium, and mercury, and 0.01% for cadmium, or qualify for an exemption to these limits as defined in the Annexes of Directive 2000/53/EC (ELV). Regarding the REACH Regulation, the information TE provides on SVHC in articles for this part number is based on the latest European Chemicals Agency (ECHA) 'Guidance on requirements for substances in articles' posted at this URL: <https://echa.europa.eu/guidance-documents/guidance-on-reach>

Compatible Parts

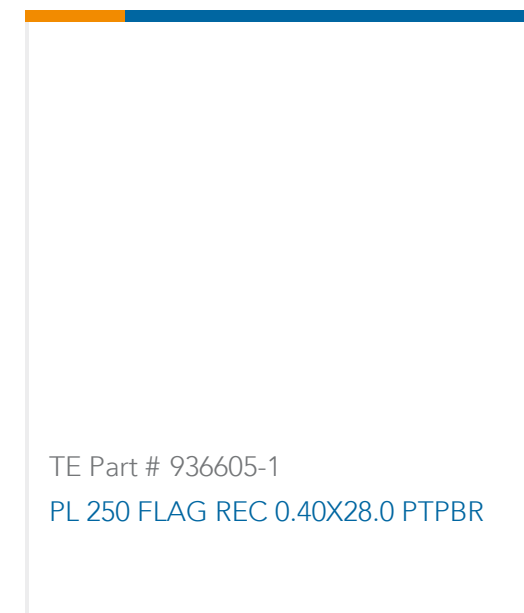
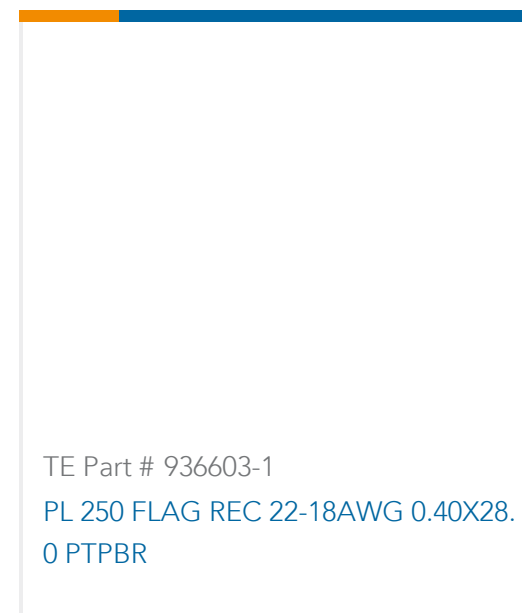

Also in the Series | Positive Lock 250

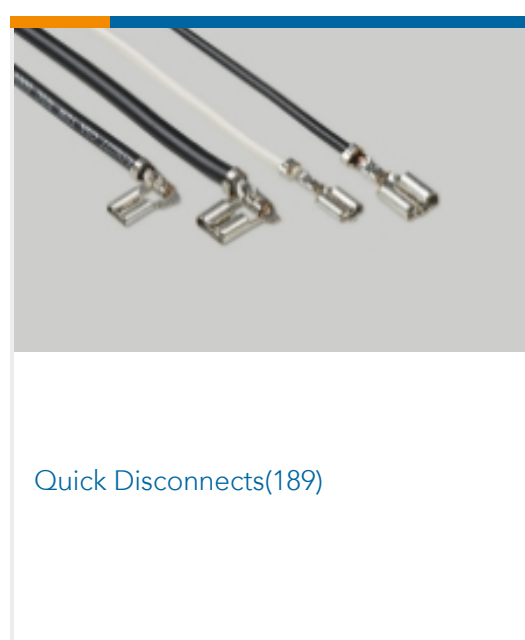
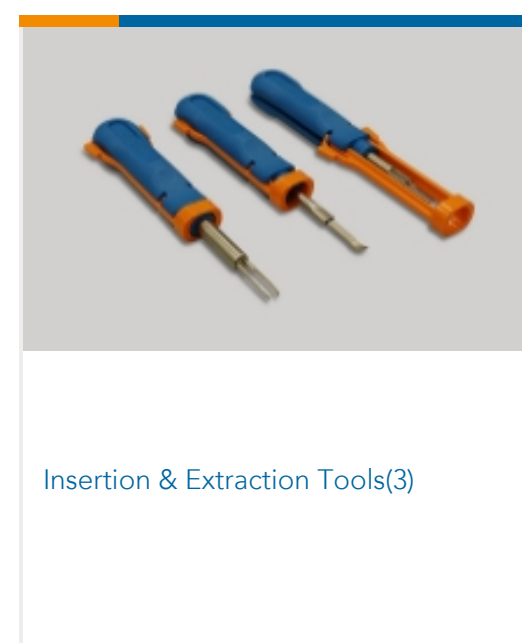
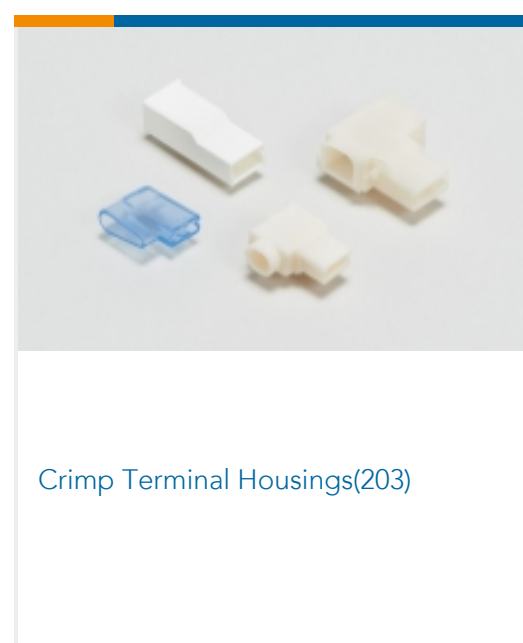
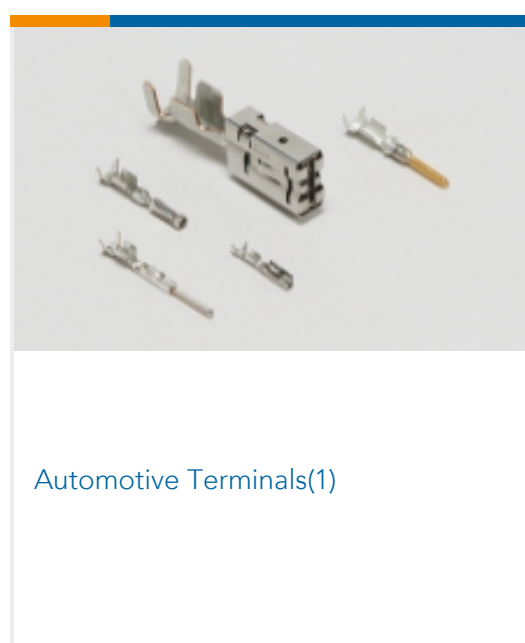

Customers Also Bought

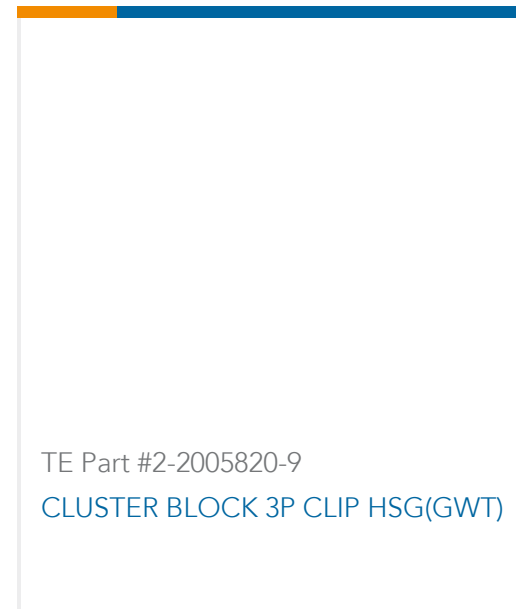
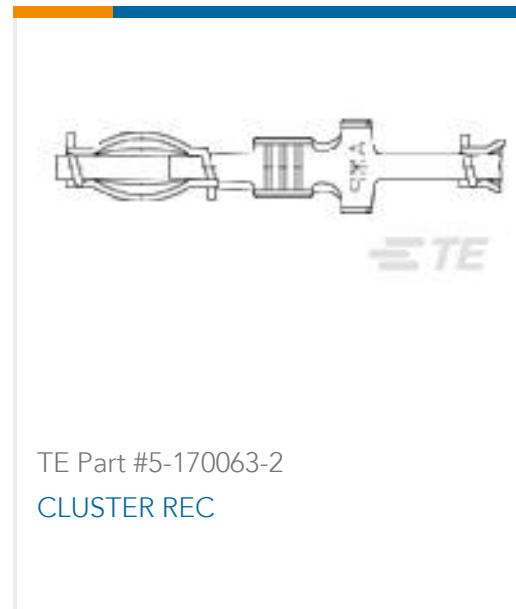

Documents

Product Drawings

POSITIVE LOCK 250 RECEPTACLE

English

CAD Files

3D PDF

3D

Customer View Model

[ENG_CVM_CVM_1743206-1_C.2d_dxf.zip](#)

English

Customer View Model

[ENG_CVM_CVM_1743206-1_C.3d_igs.zip](#)

English

Customer View Model

[ENG_CVM_CVM_1743206-1_C.3d_stp.zip](#)

English

By downloading the CAD file I accept and agree to the [Terms and Conditions](#) of use.

Product Specifications



250 Flag Positive lock 2P Housing(Pitch =12mm)

English

Product Environmental Compliance

[MD_1743206-1_072720172346_dmtec](#)

English

[MD_1743206-1_072720172346_dmtec](#)

English