



MATE-N-LOK | Mini-Universal MATE-N-LOK

TE Internal #: 170366-3

Power Contacts, Contact, 600 VAC, 600 VDC, Gold, 22 – 18 AWG

Wire Size, .3 – .89 mm<sup>2</sup> Wire Size, Wire-to-Wire, Wire & Cable, Mini-Universal MATE-N-LOK

[View on TE.com >](#)

Connectors > Power Connectors > Power Contacts

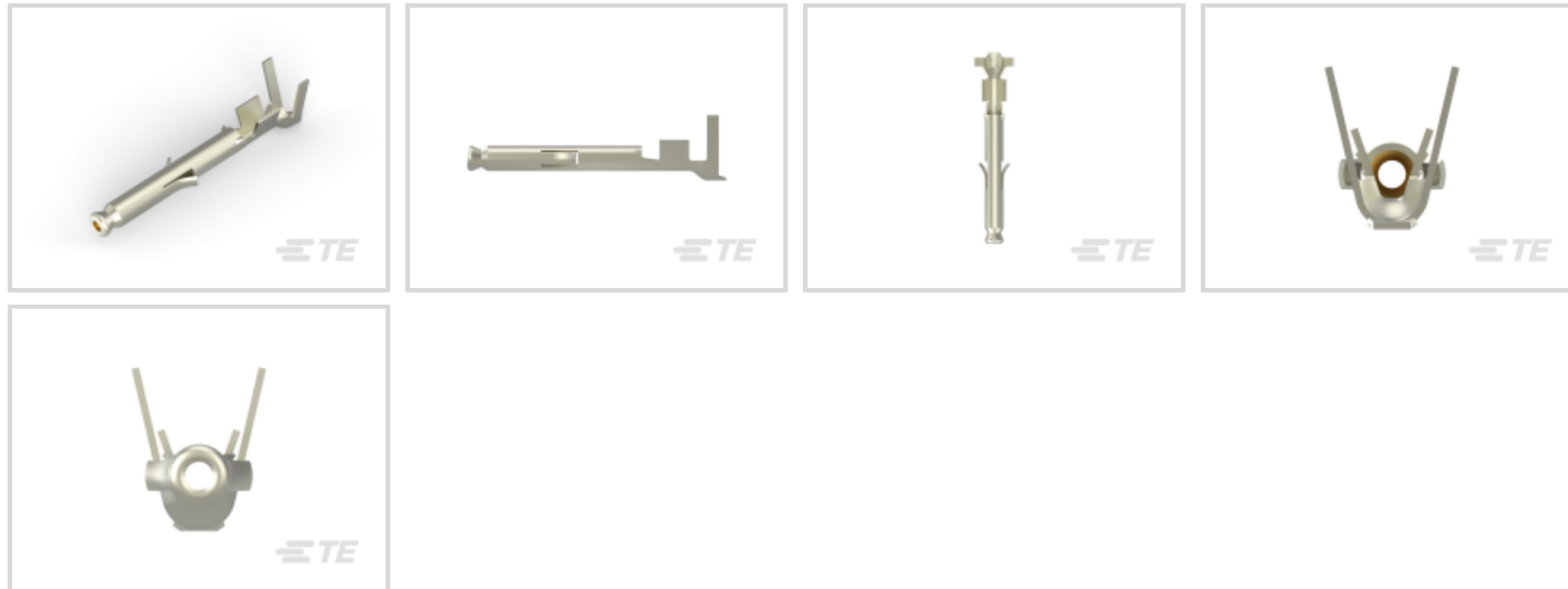

Power Contact Type: **Contact**

Operating Voltage: **600 VDC**

Contact Mating Area Plating Material: **Gold**

Wire Size: **22 – 18 AWG**

**Features**

**Product Type Features**

Power Contact Type	Contact
Connector System	Wire-to-Wire
Connector & Contact Terminates To	Wire & Cable

**Electrical Characteristics**

Operating Voltage	600 VDC
-------------------	---------

**Contact Features**

Contact Mating Area Plating Material	Gold
Contact Current Rating (Max)	7 A
Contact Type	Socket
Contact Retention Within Housing	With
Mating Pin Diameter	1 mm [.039 in]
Contact Base Material	Brass
Contact Mating Area Plating Material Thickness	.76 μm [30 μin]
Wire Contact Termination Area Plating Thickness	.76 μm [30 μin]
Wire Contact Termination Area Plating Material	Gold



Contact Orientation	Straight
Contact Underplating Material	Nickel
Barrel Type	Open Barrel
<b>Termination Features</b>	
Termination Method to Wire & Cable	Crimp
<b>Mechanical Attachment</b>	
Connector Mounting Type	Cable Mount (Free-Hanging)
Wire Insulation Support	Without
<b>Dimensions</b>	
Wire Size	.3 – .89 mm <sup>2</sup>
Accepts Wire Insulation Diameter Range	1.5 – 2.4 mm, 3.4 mm [.059 – .094 in] [.134 in]
<b>Usage Conditions</b>	
Operating Temperature Range	-20 – 105 °C [-4 – 221 °F]
<b>Operation/Application</b>	
Circuit Application	Power
<b>Industry Standards</b>	
CSA Rating	Certified
Glow Wire Rating	Standard Part - Not Glow Wire
VDE Tested	No
Agency/Standard	CSA, UL
CSA File Number	LR 7189
UL Rating	Recognized
UL File Number	E28476
<b>Packaging Features</b>	
Packaging Method	Bag
Packaging Quantity	300
<b>Other</b>	
Wire/Cable Type	Discrete Wire
Wire Type	Stranded
For Use With	Plug Housing



## Product Compliance

[For compliance documentation, visit the product page on TE.com>](#)

EU RoHS Directive 2011/65/EU	Compliant
EU ELV Directive 2000/53/EC	Compliant
China RoHS 2 Directive MIIT Order No 32, 2016	No Restricted Materials Above Threshold
EU REACH Regulation (EC) No. 1907/2006	Current ECHA Candidate List: JUNE 2022 (224) Candidate List Declared Against: JAN 2022 (223) SVHC > Threshold: Not Yet Reviewed
Halogen Content	Low Halogen - Br, Cl, F, I < 900 ppm per homogenous material. Also BFR/CFR/PVC Free
Solder Process Capability	Not applicable for solder process capability

### Product Compliance Disclaimer

This information is provided based on reasonable inquiry of our suppliers and represents our current actual knowledge based on the information they provided. This information is subject to change. The part numbers that TE has identified as EU RoHS compliant have a maximum concentration of 0.1% by weight in homogenous materials for lead, hexavalent chromium, mercury, PBB, PBDE, DBP, BBP, DEHP, DIBP, and 0.01% for cadmium, or qualify for an exemption to these limits as defined in the Annexes of Directive 2011/65/EU (RoHS2). Finished electrical and electronic equipment products will be CE marked as required by Directive 2011/65/EU. Components may not be CE marked. Additionally, the part numbers that TE has identified as EU ELV compliant have a maximum concentration of 0.1% by weight in homogenous materials for lead, hexavalent chromium, and mercury, and 0.01% for cadmium, or qualify for an exemption to these limits as defined in the Annexes of Directive 2000/53/EC (ELV). Regarding the REACH Regulation, the information TE provides on SVHC in articles for this part number is based on the latest European Chemicals Agency (ECHA) 'Guidance on requirements for substances in articles' posted at this URL: <https://echa.europa.eu/guidance-documents/guidance-on-reach>

## Compatible Parts





## Also in the Series | Mini-Universal MATE-N-LOK

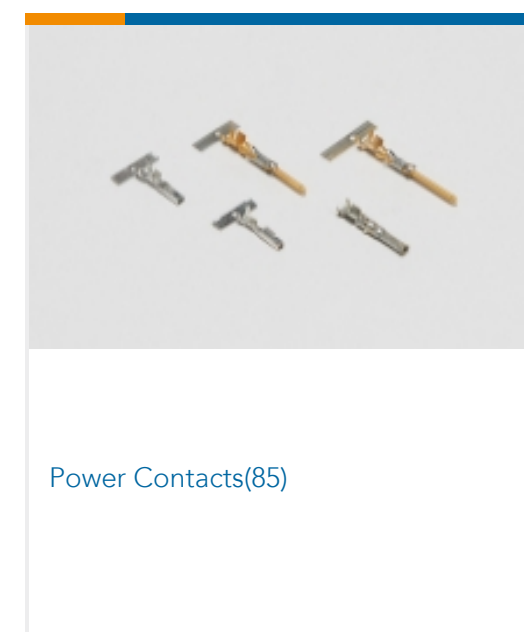
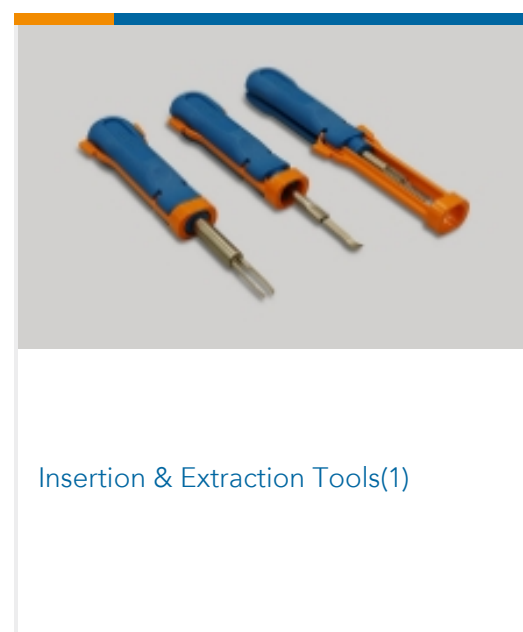
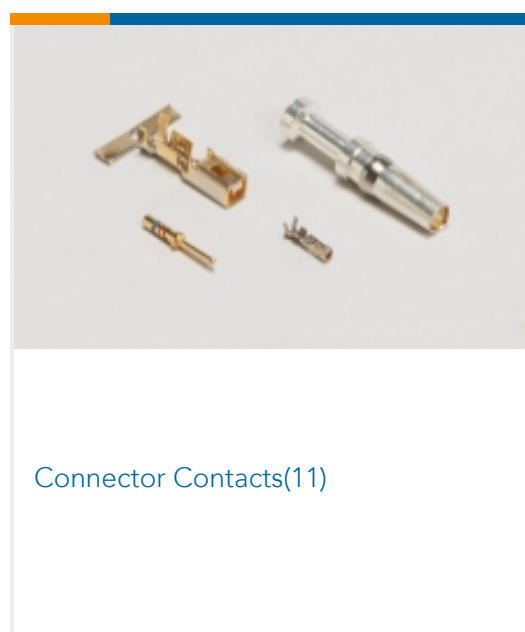



Rectangular Backshells & Clamps(2)

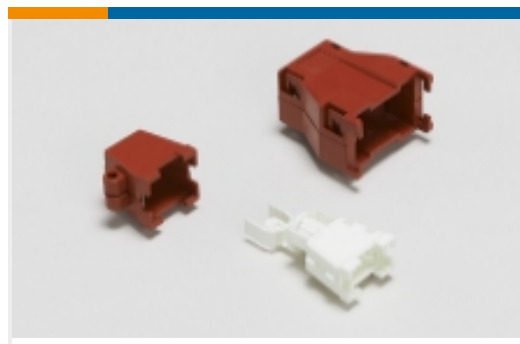

Rectangular Boots & Strain Relief(2)

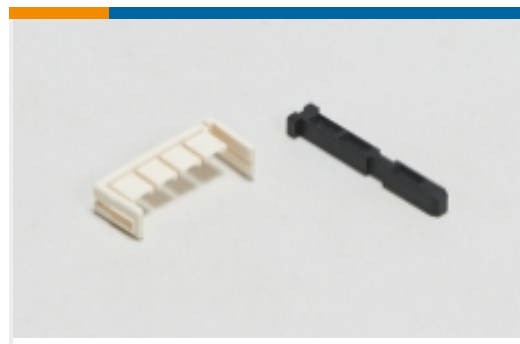

Rectangular Connector Keying Plugs(2)



Rectangular Connector Locking(2)



Rectangular Connector Seals(20)



Rectangular Power Connectors(283)

## Customers Also Bought



TE Part #172159-1  
4 CIR UNIV M-N-L CAP



TE Part #172167-1  
4 CIR UNIV M-N-L PLUG



TE Part #172165-1  
2 CIR UNIV M-N-L PLUG NATL

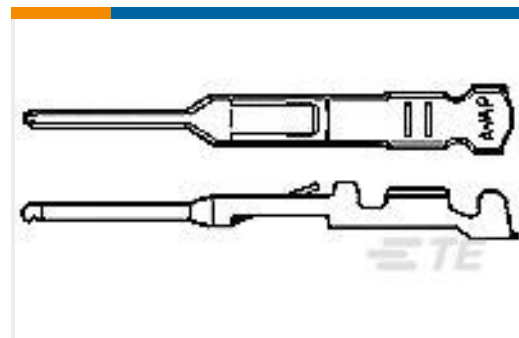

TE Part #170429-3  
SERIE EI STIFTKONT



TE Part #YDTS20F13-98SAV001  
RECP ASSY



TE Part #AFD56-22-55PX-1A  
PLUG ASSY



TE Part #ZPF00000000096069  
FDBA 50-22-55 PN-K-B6035



TE Part #YAFD50-12-10SNC127  
RECP ASSY

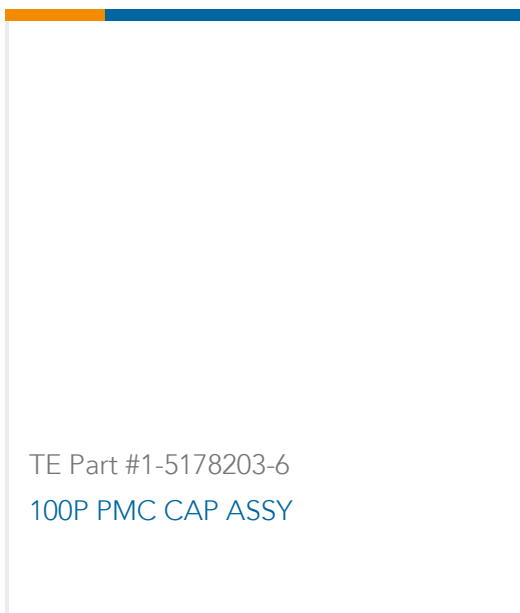

TE Part #1-5178203-6  
100P PMC CAP ASSY

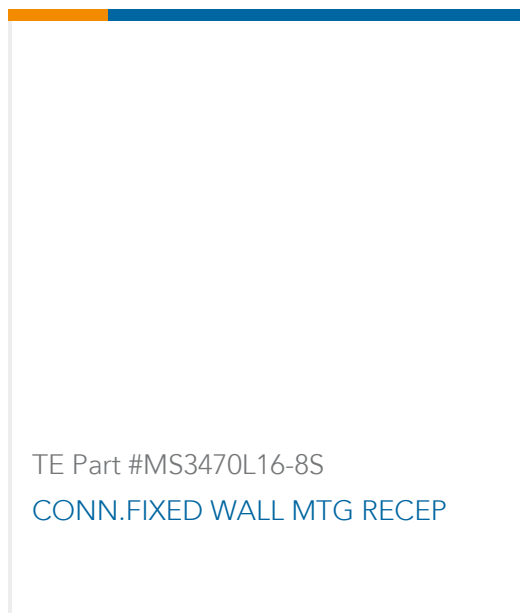

TE Part #MS3470L16-8S  
CONN.FIXED WALL MTG RECEP

## Documents



### CAD Files

#### 3D PDF

3D

#### Customer View Model

[ENG\\_CVM\\_CVM\\_170366-3\\_1\\_c-170366-3-1.2d\\_dxf.zip](#)

English

#### Customer View Model

[ENG\\_CVM\\_CVM\\_170366-3\\_1\\_c-170366-3-1.3d\\_igs.zip](#)

English

#### Customer View Model

[ENG\\_CVM\\_CVM\\_170366-3\\_1\\_c-170366-3-1.3d\\_stp.zip](#)

English

By downloading the CAD file I accept and agree to the [Terms and Conditions](#) of use.

### Product Specifications

#### Crimping of Mini-Universal MATE-N-LOK Contact

Japanese

#### Application Specification

Japanese

### Product Environmental Compliance

[MD\\_170366-3\\_08012011316](#)

English

[MD\\_170366-3\\_08012011316](#)

English

### Instruction Sheets

#### Instruction Sheet (non U.S.)

Japanese

#### Mini-Universal MATE-N-LOK Connector

Japanese