

172335-1 ✓ ACTIVE

MATE-N-LOK | Mini-Universal MATE-N-LOK

TE Internal #: 172335-1

Rectangular Power Connectors, Housing, Plug, Wire-to-Wire, 1 Position, Wire & Cable, UL 94V-2, Mini-Universal MATE-N-LOK

[View on TE.com >](#)



Connectors > Power Connectors > Rectangular Power > Rectangular Power Connectors



Rectangular Power Connector Type: **Housing**

Connector & Housing Type: **Plug**

Connector System: **Wire-to-Wire**

Number of Positions: **1**

Sealable: **No**

## Features

### Product Type Features

Rectangular Power Connector Type	Housing
Connector & Housing Type	Plug
Connector System	Wire-to-Wire
Sealable	No
Connector & Contact Terminates To	Wire & Cable

### Configuration Features

Number of Positions	1
Number of Rows	1

### Electrical Characteristics

Operating Voltage	600 VDC
-------------------	---------

### Contact Features

Multiple Contact Types	Without
Contact Layout	Inline
Contact Retention Within Housing	Without



Contact Type	Socket
--------------	--------

### Termination Features

Termination Method to Wire & Cable	Crimp
------------------------------------	-------

### Mechanical Attachment

Panel Mount Feature	Without
---------------------	---------

Connector Mounting Type	Cable Mount (Free-Hanging)
-------------------------	----------------------------

### Housing Features

Housing Color	Natural
---------------	---------

Housing Material	Nylon 6/6
------------------	-----------

### Usage Conditions

Operating Temperature Range	-20 – 105 °C[-4 – 221 °F]
-----------------------------	---------------------------

Insertion Force	1.5 kg
-----------------	--------

### Operation/Application

Assembly Integration Feature	Without
------------------------------	---------

Circuit Application	Power & Signal
---------------------	----------------

### Industry Standards

CSA Rating	Certified
------------	-----------

UL Flammability Rating	UL 94V-2
------------------------	----------

Glow Wire Rating	Standard Part - Not Glow Wire
------------------	-------------------------------

UL Rating	Recognized
-----------	------------

Agency/Standard Number	E28476
------------------------	--------

CSA File Number	LR7189
-----------------	--------

VDE Tested	No
------------	----

Agency/Standard	CSA, UL
-----------------	---------

### Packaging Features

Packaging Method	Bag
------------------	-----

Packaging Quantity	500
--------------------	-----

### Other

For Use With	Mini-Universal MATE-N-LOK Cap Housing
--------------	---------------------------------------

## Product Compliance

[For compliance documentation, visit the product page on TE.com>](#)



EU RoHS Directive 2011/65/EU	Compliant
EU ELV Directive 2000/53/EC	Compliant
China RoHS 2 Directive MIIT Order No 32, 2016	No Restricted Materials Above Threshold
EU REACH Regulation (EC) No. 1907/2006	Current ECHA Candidate List: JUNE 2022 (224) Candidate List Declared Against: JUNE 2022 (224) Does not contain REACH SVHC
Halogen Content	Low Halogen - Br, Cl, F, I < 900 ppm per homogenous material. Also BFR/CFR/PVC Free
Solder Process Capability	Not applicable for solder process capability

Product Compliance Disclaimer

This information is provided based on reasonable inquiry of our suppliers and represents our current actual knowledge based on the information they provided. This information is subject to change. The part numbers that TE has identified as EU RoHS compliant have a maximum concentration of 0.1% by weight in homogenous materials for lead, hexavalent chromium, mercury, PBB, PBDE, DBP, BBP, DEHP, DIBP, and 0.01% for cadmium, or qualify for an exemption to these limits as defined in the Annexes of Directive 2011/65/EU (RoHS2). Finished electrical and electronic equipment products will be CE marked as required by Directive 2011/65/EU. Components may not be CE marked. Additionally, the part numbers that TE has identified as EU ELV compliant have a maximum concentration of 0.1% by weight in homogenous materials for lead, hexavalent chromium, and mercury, and 0.01% for cadmium, or qualify for an exemption to these limits as defined in the Annexes of Directive 2000/53/EC (ELV). Regarding the REACH Regulation, the information TE provides on SVHC in articles for this part number is based on the latest European Chemicals Agency (ECHA) 'Guidance on requirements for substances in articles' posted at this URL: <https://echa.europa.eu/guidance-documents/guidance-on-reach>

## Compatible Parts

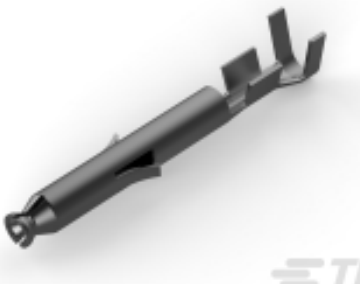
 <p>TE Part # 1-770985-0 MINI UMNL PIN 26-22AWG AU LP</p>	 <p>TE Part # 1-770987-0 MINI UMNL PIN 22-18 AWG AU LP</p>	 <p>TE Part # 770988-3 MINI UMNL SOK 22-18AWG AU LP</p>	 <p>TE Part # 1-794059-0 MINI UMNL PIN L/P LF</p>
 <p>TE Part # 770988-1 MINI UMNL SOK 22-18AWG SN LP</p>	 <p>TE Part # 770986-1 MINI UMNL SOK 26-22AWG SN LP</p>	 <p>TE Part # 170365-3 MINI UNIVERSAL M-N-L SOCKET LP</p>	 <p>TE Part # 170364-3 MINI UNIVERSAL M-N-L PIN LP</p>



Also in the Series | Mini-Universal MATE-N-LOK

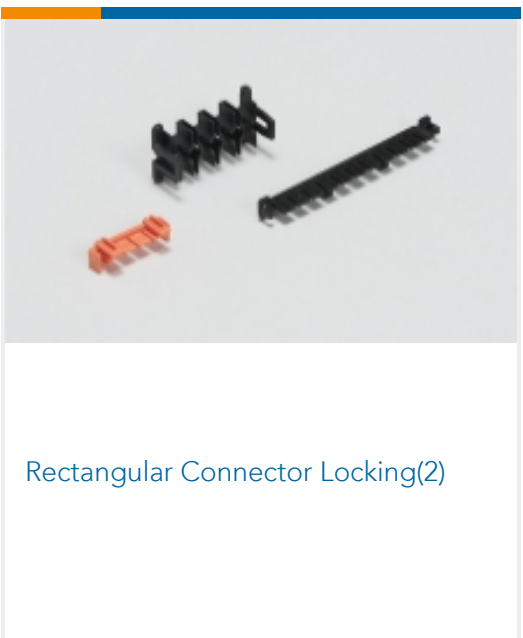
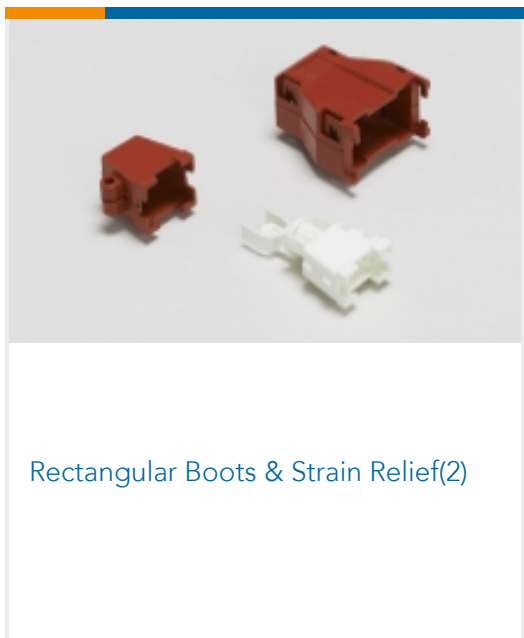
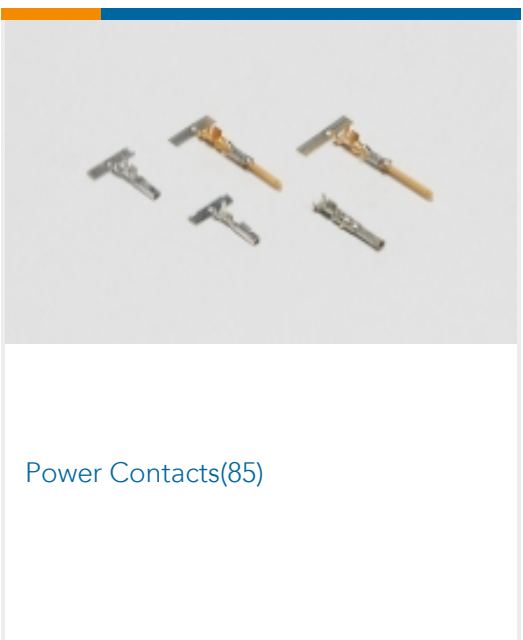
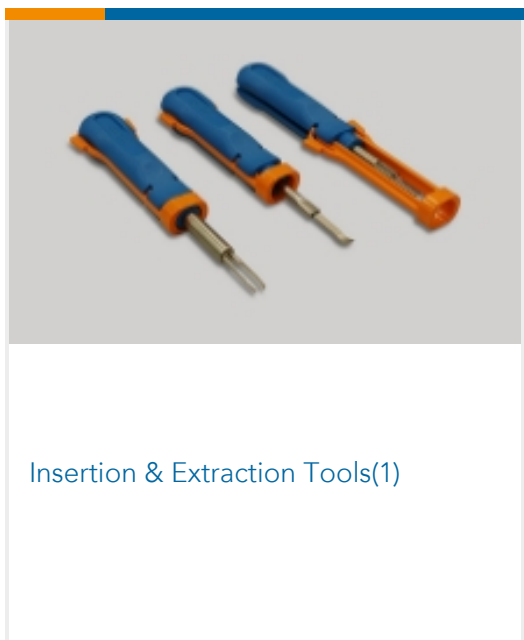
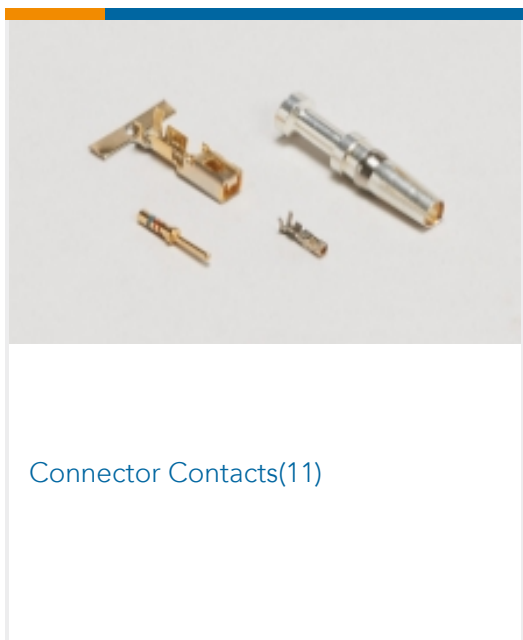

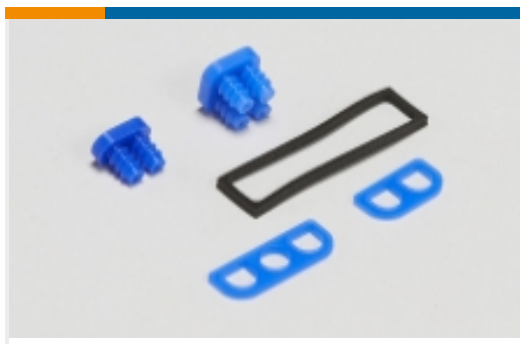

Rectangular Connector Seals(20)



Rectangular Power Connectors(283)

## Customers Also Bought



TE Part #9-160477-2  
PIDG FASTON RECPT QUICK DISCONNECTS



TE Part #130205  
PIDG RING

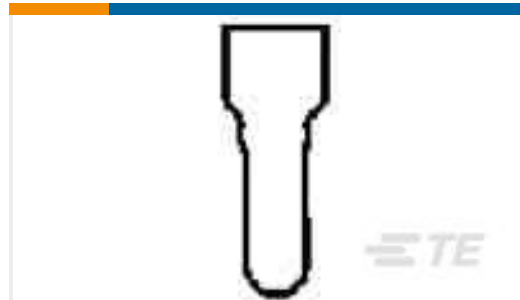

TE Part #55927-1  
SPLICE WIRE CE BLACK 22-14



TE Part #172156-1  
1 CIR UNIV M-N-L CAP



TE Part #1-154719-0  
PL 250 REC HSG 1P NYLON NAT

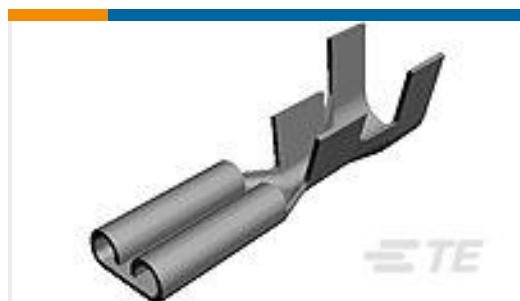

TE Part #5-160433-6  
187 FASTON REC 20-16 AWG TPBR

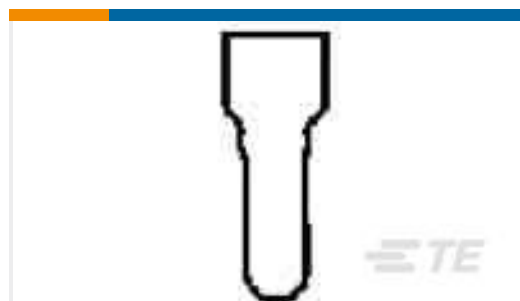

TE Part #55929-1  
SPLICE WIRE CE BLACK 22-10



TE Part #140635  
RING TONGUE .157 (4.0 MM)  
TERMINAL BR



TE Part #1579024-2  
HTV10 HAND TOOL MATE-N-LOK,  
0.5-2.1

## Documents

### Product Drawings

[MINI UMNL PLUG HOUSING 1P](#)

English

### CAD Files

[3D PDF](#)

English

### Customer View Model

[ENG\\_CVM\\_172335-1\\_A1.2d\\_dxf.zip](#)



English

**Customer View Model**

[ENG\\_CVM\\_172335-1\\_A1.3d\\_igs.zip](#)

English

**Customer View Model**

[ENG\\_CVM\\_172335-1\\_A1.3d\\_stp.zip](#)

English

By downloading the CAD file I accept and agree to the [Terms and Conditions](#) of use.

---

**Datasheets & Catalog Pages**

[SOFT\\_SHELL\\_PIN\\_AND\\_SOCKET\\_CONNECTORS\\_CATALOG](#)

English

[1-1773458-0\\_MINI\\_UNIVERSAL\\_MATE\\_N\\_LOK\\_CONNECTOR\\_SYSTEM\\_QRG](#)

English

---

**Product Specifications**

[Application Specification](#)

English

---

**Product Environmental Compliance**

[TE Material Declaration](#)

English

---

**Instruction Sheets**

[Instruction Sheet \(U.S.\)](#)

English

[Instruction Sheet \(U.S.\)](#)

English

---

**Agency Approvals**

[Agency Approval Document](#)

English

[Agency Approval Document](#)

English