

1658623-1 ✓ ACTIVE



## AMP-LATCH

TE Internal #: 1658623-1

Ribbon Cable Connectors, Wire-to-Board, 10 Position, .1 in [2.54 mm] Centerline, Vertical, Through Hole - Solder, Insulation

Displacement (IDC), 2 Row

[View on TE.com >](#)

Connectors > PCB Connectors > Wire-to-Board Connectors > FFC, FPC & Ribbon Connectors > Ribbon Cable Connectors



Connector System: **Wire-to-Board**

Number of Positions: **10**

Centerline (Pitch): **2.54 mm [ .1 in ]**

PCB Mount Retention: **Without**

PCB Mount Orientation: **Vertical**

### Features

#### Product Type Features

Connector Type	Connector Assembly
Ribbon Cable Connector Header Type	Pin Header
Connector Product Type	Connector Assembly
Connector System	Wire-to-Board
Connector & Housing Type	Receptacle
Connector & Contact Terminates To	Wire & Cable

#### Configuration Features

Compatible With Wire & Cable Type	Ribbon Cable
Number of Positions	10
PCB Mount Orientation	Vertical
Number of Rows	2

#### Electrical Characteristics

UL Voltage Rating	250 VAC
Insulation Resistance	5000 MΩ



Operating Voltage	250 VAC
-------------------	---------

### Body Features

Daisy Chain	Without
-------------	---------

Connector Profile	Low
-------------------	-----

### Contact Features

Mating Square Post Dimension	.64 mm[.025 in]
------------------------------	-----------------

Mating Pin Diameter	.64 mm[.025 in]
---------------------	-----------------

Contact Type	Socket
--------------	--------

Wire Contact Termination Area Plating Thickness	1.27 $\mu$ m[50 $\mu$ in]
---	---------------------------

Wire Contact Termination Area Plating Material	Tin
--	-----

Contact Mating Area Plating Material Thickness	.76 $\mu$ m[29.92 $\mu$ in]
--	-----------------------------

Contact Mating Area Plating Material	Gold or Palladium Nickel or Performance Based
--------------------------------------	---

Contact Shape & Form	Tuning Fork
----------------------	-------------

Contact Base Material	Phosphor Bronze
-----------------------	-----------------

Contact Current Rating (Max)	1 A
------------------------------	-----

### Termination Features

Termination Method to Printed Circuit Board	Through Hole - Solder
---	-----------------------

Termination Method to Wire & Cable	Insulation Displacement (IDC)
------------------------------------	-------------------------------

### Mechanical Attachment

Mating Alignment	With
------------------	------

PCB Mount Alignment	Without
---------------------	---------

Panel Mount Feature	Without
---------------------	---------

PCB Mount Retention	Without
---------------------	---------

Mating Alignment Type	Polarization
-----------------------	--------------

Mating Retention	Without
------------------	---------

Connector Mounting Type	Cable Mount (Free-Hanging)
-------------------------	----------------------------

### Housing Features

Housing Material	Thermoplastic
------------------	---------------

Housing Color	Black
---------------	-------

Centerline (Pitch)	2.54 mm[.1 in]
--------------------	----------------

### Dimensions



Connector Length	17.27 mm[.68 in]
Connector Height	15.16 mm[.597 in]
Connector Width	6.1 mm[.24 in]
Wire Size	.08 – .15 mm <sup>2</sup>
Accepts Wire Insulation Diameter Range	.79 – .94 mm[.031 – .037 in]
Row-to-Row Spacing	2.54 mm[.1 in]

### Usage Conditions

Operating Temperature Range	-65 – 105 °C[-85 – 221 °F]
-----------------------------	----------------------------

### Operation/Application

Circuit Application	Signal
---------------------	--------

### Industry Standards

CSA File Number	LR 7189
UL Rating	Recognized
UL File Number	E28476
Agency/Standard	CSA, UL
UL Flammability Rating	UL 94V-0

### Packaging Features

Packaging Quantity	60
Packaging Method	Box & Tube, Tube

### Product Compliance

[For compliance documentation, visit the product page on TE.com>](#)

EU RoHS Directive 2011/65/EU	Compliant
EU ELV Directive 2000/53/EC	Compliant
China RoHS 2 Directive MIIT Order No 32, 2016	No Restricted Materials Above Threshold
EU REACH Regulation (EC) No. 1907/2006	Current ECHA Candidate List: JUNE 2022 (224) Candidate List Declared Against: JAN 2022 (223) SVHC > Threshold: Not Yet Reviewed
Halogen Content	Not Low Halogen - contains Br or Cl > 900 ppm.
Solder Process Capability	Not applicable for solder process capability

Product Compliance Disclaimer

This information is provided based on reasonable inquiry of our suppliers and represents our current actual knowledge based on the information they provided. This information is subject to change. The part numbers that TE has identified as EU RoHS compliant have a maximum concentration of 0.1% by weight in homogenous materials for lead, hexavalent chromium, mercury, PBB, PBDE, DBP, BBP, DEHP, DIBP, and 0.01% for cadmium, or qualify for an exemption to these limits as defined in the Annexes of Directive 2011/65/EU (RoHS2). Finished electrical and electronic equipment products will be CE marked as required by Directive 2011/65/EU. Components may not be CE marked. Additionally, the part numbers that TE has identified as EU ELV compliant have a maximum concentration of 0.1% by weight in homogenous materials for lead, hexavalent chromium, and mercury, and 0.01% for cadmium, or qualify for an exemption to these limits as defined in the Annexes of Directive 2000/53/EC (ELV). Regarding the REACH Regulation, the information TE provides on SVHC in articles for this part number is based on the latest European Chemicals Agency (ECHA) 'Guidance on requirements for substances in articles' posted at this URL: <https://echa.europa.eu/guidance-documents/guidance-on-reach>

## Compatible Parts

 <p>TE Part # CAT-AM74-UN384H AMP-LATCH UNIVERSAL HEADERS</p>	 <p>TE Part # 499252-5 010 STRAIN RELIEF A-L RCPT</p>	 <p>TE Part # 1-111446-4 10 UNIV I/O, NO EARS, LEAD FREE</p>	 <p>TE Part # 1-111504-4 10 UNIV I/O, NO EARS, LEAD FREE</p>
 <p>TE Part # 2-1761605-3 IDC LOW PRO HDR 10P RA BLUE</p>	 <p>TE Part # 1761681-3 IDC LOW PRO HDR 10P VERT HT BLACK</p>	 <p>TE Part # 2-1761603-3 IDC LOW PRO HDR 10P VERT BLUE</p>	 <p>TE Part # 1761607-3 IDC LOW PRO HDR 10P RA LG LAT</p>
 <p>TE Part # 5104338-1 A/L LOW PRO HDR 10P VERT HT</p>	 <p>TE Part # 5103311-1 A/L LOW PRO HDR 10P RA BLACK</p>	 <p>TE Part # 2-1761713-3 IDC LOW PRO HDR 10P VERT SHT L</p>	 <p>TE Part # 1761609-3 IDC LOW PRO HDR 10P RA SHT LAT</p>
 <p>TE Part # 1-111506-6 010 UNIV I/O 30DP SLOT LTCH</p>	 <p>TE Part # 1761606-3 IDC LOW PRO HDR 10P VERT LG LAT BLK</p>	 <p>TE Part # 2-1761711-3 IDC LOW PRO HDR 10P VERT LG LA</p>	 <p>TE Part # 1761608-3 IDC LOW PRO HDR 10P VERT SHT L</p>

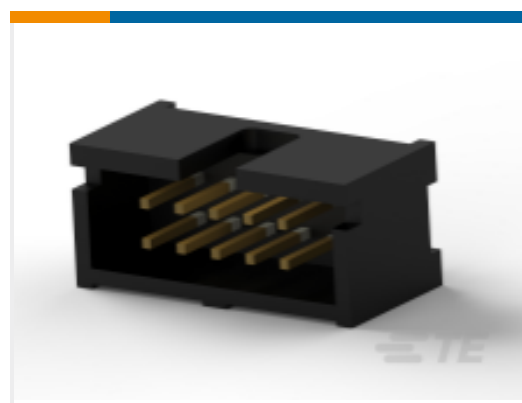

TE Part # 5103310-1  
A/L LOW PRO HDR 10P RA BLACK

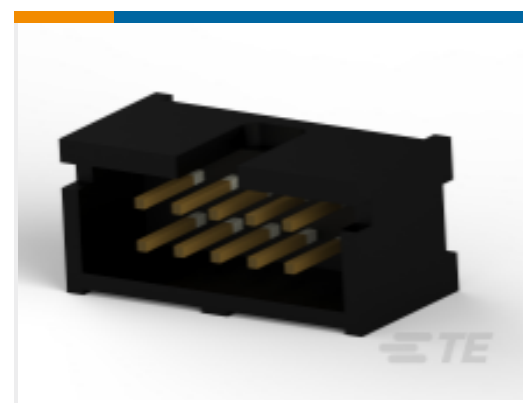

TE Part # 5103309-1  
A/L LOW PRO HDR 10P VERT BLACK

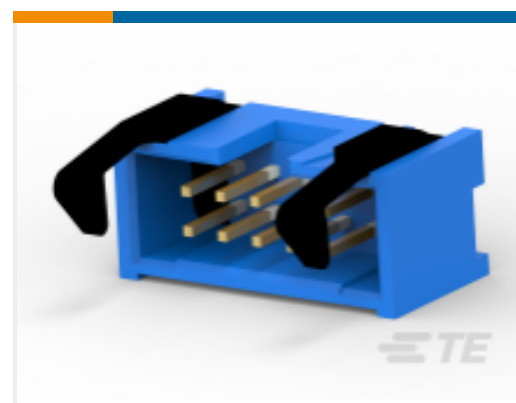

TE Part # 2-1761608-3  
IDC LOW PRO HDR 10P VERT SHT L

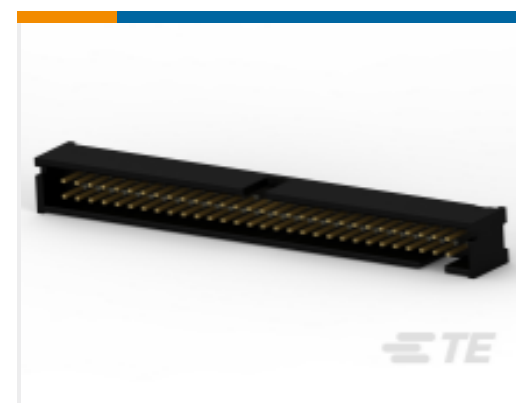

TE Part # 5103308-1  
A/L LOW PRO HDR 10P VERT BLACK

## Customers Also Bought



TE Part #2-6609006-5  
15EJT1=F8137

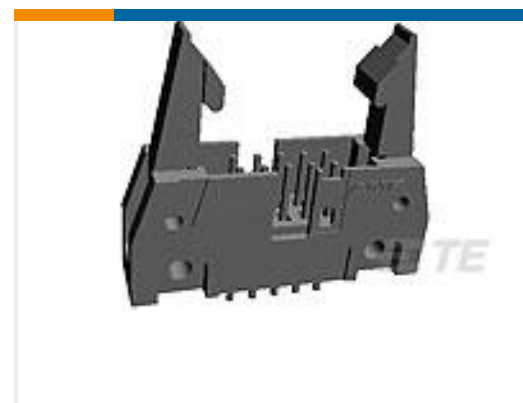

TE Part #5499160-6  
A/L UNIV HDR 26P VERT SHT LAT

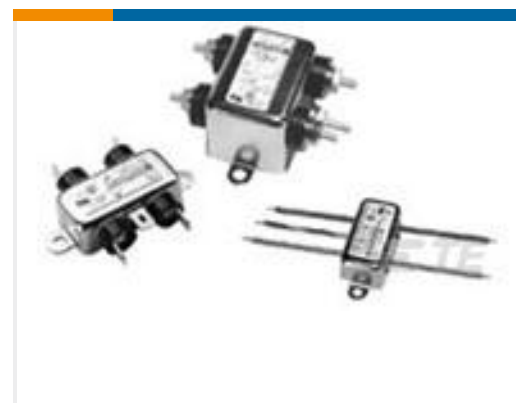

TE Part #1-6609021-0  
10VB3=F7129 S0



TE Part #5088450-9  
Ribbon Cable Connector: Pull Loop

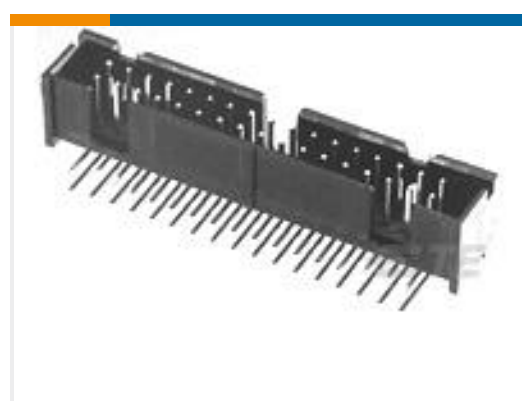

TE Part #5103310-8  
A/L LOW PRO HDR 40P RA BLACK



TE Part #1658623-6  
26 NOVO MIL 30DP, LEAD FREE



TE Part #1658623-7  
30 NOVO MIL 30DP, LEAD FREE



TE Part #1926671-1  
CROWN CLIP SENIOR POWER SKT  
GOLD PLATING

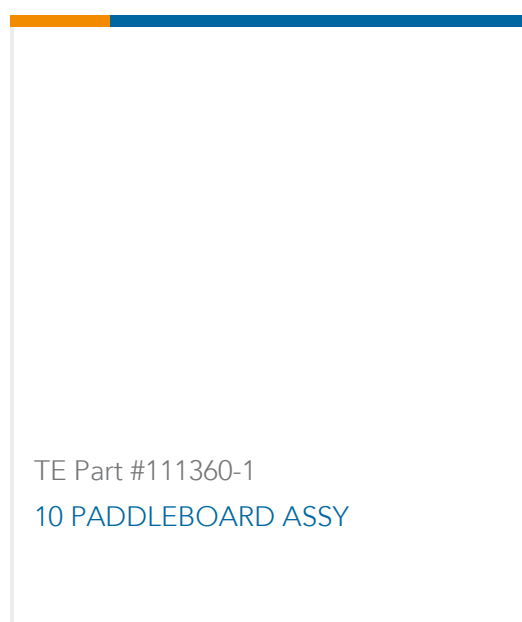

TE Part #111360-1  
10 PADDLEBOARD ASSY

## Documents

### Product Drawings

10 NOVO MIL 30DP, LEAD FREE

English

### CAD Files

Customer View Model

ENG\_CVM\_CVM\_1658623-1\_C.2d\_dxf.zip

English

3D PDF



3D

Customer View Model

[ENG\\_CVM\\_CVM\\_1658623-1\\_C.3d\\_igs.zip](#)

English

Customer View Model

[ENG\\_CVM\\_CVM\\_1658623-1\\_C.3d\\_stp.zip](#)

English

By downloading the CAD file I accept and agree to the [Terms and Conditions](#) of use.

---

### Datasheets & Catalog Pages

[Ribbon Cable Interconnect Solutions](#)

English

---

### Product Specifications

[Application Specification](#)

English

---

### Product Environmental Compliance

[MD\\_1658623-1\\_012920141157\\_dmtec](#)

English

[MD\\_1658623-1\\_012920141157\\_dmtec](#)

English

---

### Instruction Sheets

[Instruction Sheet \(U.S.\)](#)

English

---

### Agency Approvals

[Agency Approval Document](#)

English