



MATE-N-LOK | Mini-Universal MATE-N-LOK

TE Internal #: 170362-4

Power Contacts, Contact, 600 VAC, 600 VDC, Pre-Tin, 22 – 18 AWG

Wire Size, .3 – .89 mm² Wire Size, Wire-to-Wire, Mini-Universal

MATE-N-LOK

[View on TE.com >](#)

Connectors > Power Connectors > Power Contacts

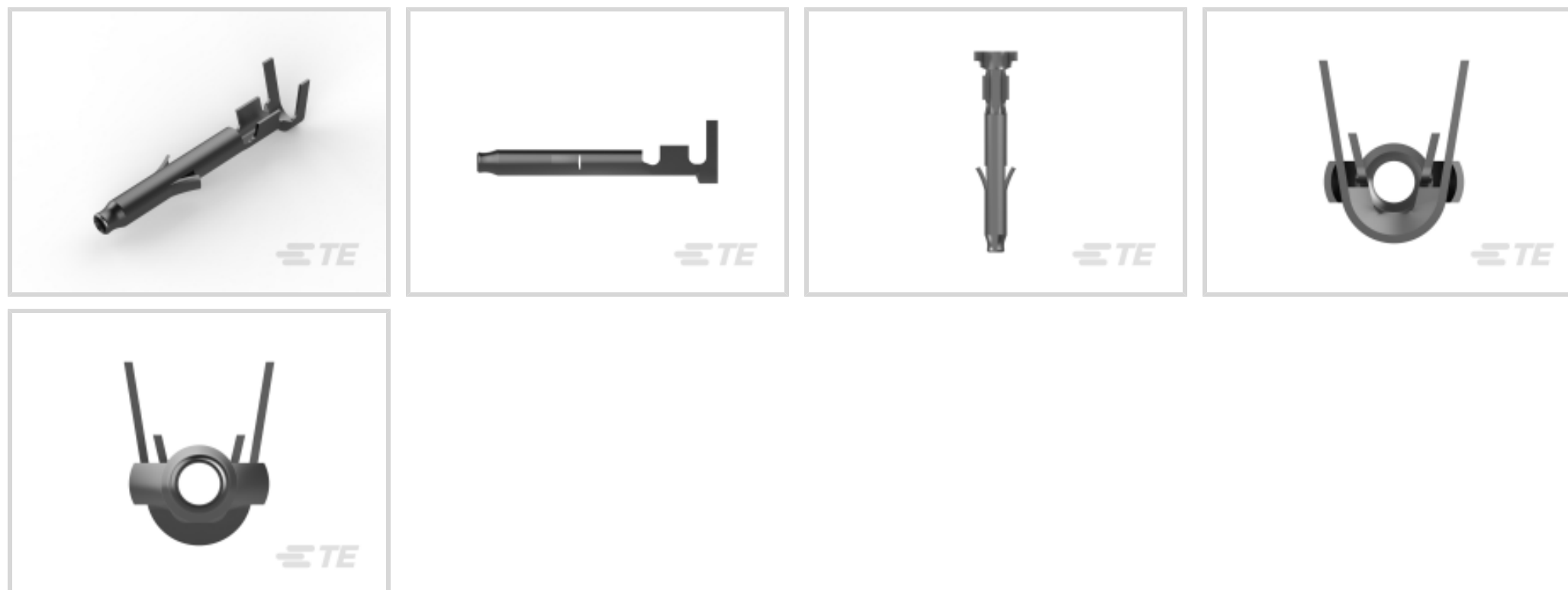

Power Contact Type: **Contact**

Operating Voltage: **600 VDC**

Contact Mating Area Plating Material: **Pre-Tin**

Wire Size: **22 – 18 AWG**

Features

Product Type Features

Power Contact Type	Contact
Connector System	Wire-to-Wire
Connector & Contact Terminates To	Wire & Cable

Electrical Characteristics

Operating Voltage	600 VDC
-------------------	---------

Contact Features

Contact Mating Area Plating Material	Pre-Tin
Contact Current Rating (Max)	7 A
Contact Type	Socket
Contact Retention Within Housing	With
Mating Pin Diameter	1 mm [.039 in]
Contact Base Material	Phosphor Bronze
Contact Mating Area Plating Material Thickness	.8 μm [31.49 μin]
Wire Contact Termination Area Plating Thickness	.8 μm [31.49 μin]
Wire Contact Termination Area Plating Material	Pre-Tin



Wire Contact Termination Area Plating Material Finish	Matte
Contact Orientation	Straight
Barrel Type	Open Barrel

Termination Features

Termination Method to Wire & Cable	Crimp
------------------------------------	-------

Mechanical Attachment

Connector Mounting Type	Cable Mount (Free-Hanging)
Wire Insulation Support	Without

Dimensions

Wire Size	.3 – .89 mm ²
Accepts Wire Insulation Diameter Range	1.5 – 2.4 mm, 3.4 mm [.059 – .094 in] [.134 in]

Usage Conditions

Operating Temperature Range	-20 – 105 °C [-4 – 221 °F]
-----------------------------	----------------------------

Operation/Application

Circuit Application	Power
---------------------	-------

Industry Standards

CSA Rating	Certified
Glow Wire Rating	Standard Part - Not Glow Wire
VDE Tested	No
Agency/Standard	CSA, UL
CSA File Number	LR 7189
UL Rating	Recognized
UL File Number	E28476

Packaging Features

Packaging Method	Reel
Packaging Quantity	4000

Other

Wire/Cable Type	Discrete Wire
Wire Type	Stranded
For Use With	Plug Housing



Product Compliance

[For compliance documentation, visit the product page on TE.com>](#)

EU RoHS Directive 2011/65/EU	Compliant
EU ELV Directive 2000/53/EC	Compliant
China RoHS 2 Directive MIIT Order No 32, 2016	No Restricted Materials Above Threshold
EU REACH Regulation (EC) No. 1907/2006	Current ECHA Candidate List: JUNE 2022 (224) Candidate List Declared Against: JAN 2022 (223) SVHC > Threshold: Not Yet Reviewed
Halogen Content	Low Halogen - Br, Cl, F, I < 900 ppm per homogenous material. Also BFR/CFR/PVC Free
Solder Process Capability	Not applicable for solder process capability

Product Compliance Disclaimer

This information is provided based on reasonable inquiry of our suppliers and represents our current actual knowledge based on the information they provided. This information is subject to change. The part numbers that TE has identified as EU RoHS compliant have a maximum concentration of 0.1% by weight in homogenous materials for lead, hexavalent chromium, mercury, PBB, PBDE, DBP, BBP, DEHP, DIBP, and 0.01% for cadmium, or qualify for an exemption to these limits as defined in the Annexes of Directive 2011/65/EU (RoHS2). Finished electrical and electronic equipment products will be CE marked as required by Directive 2011/65/EU. Components may not be CE marked. Additionally, the part numbers that TE has identified as EU ELV compliant have a maximum concentration of 0.1% by weight in homogenous materials for lead, hexavalent chromium, and mercury, and 0.01% for cadmium, or qualify for an exemption to these limits as defined in the Annexes of Directive 2000/53/EC (ELV). Regarding the REACH Regulation, the information TE provides on SVHC in articles for this part number is based on the latest European Chemicals Agency (ECHA) 'Guidance on requirements for substances in articles' posted at this URL: <https://echa.europa.eu/guidance-documents/guidance-on-reach>

Compatible Parts





Also in the Series | Mini-Universal MATE-N-LOK

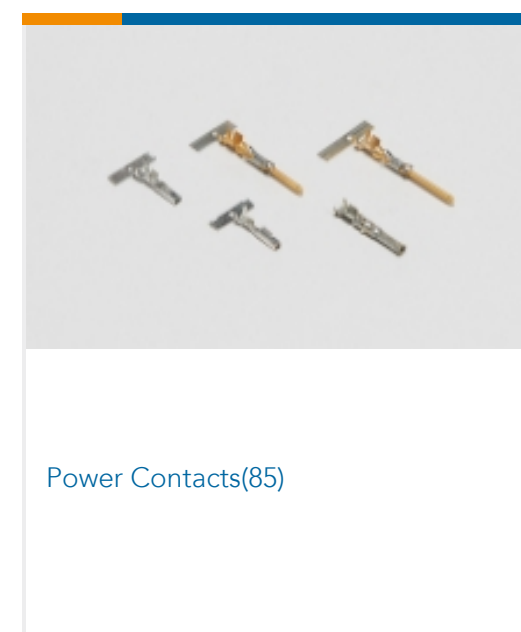
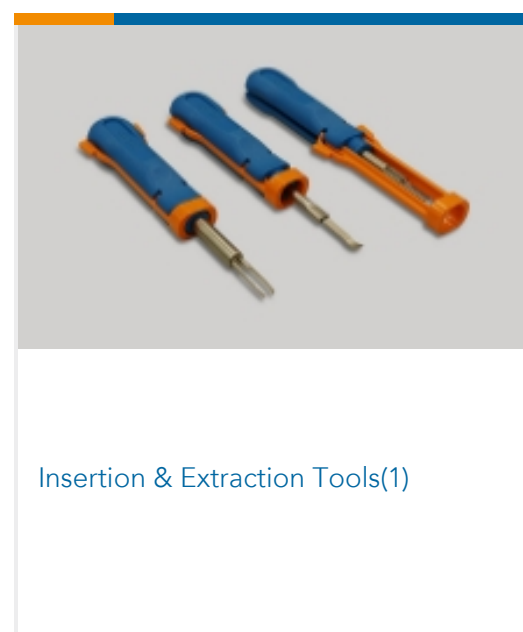
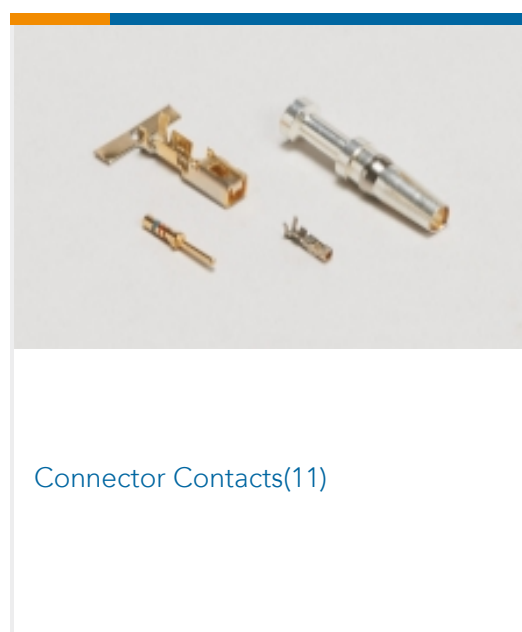



Rectangular Backshells & Clamps(2)

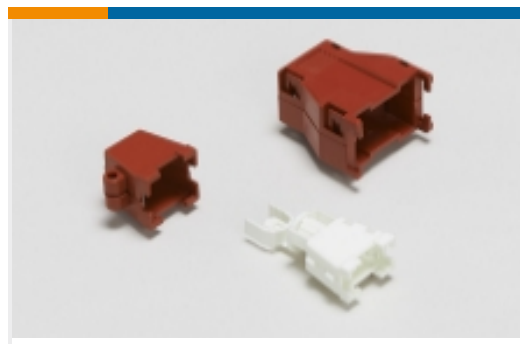

Rectangular Boots & Strain Relief(2)

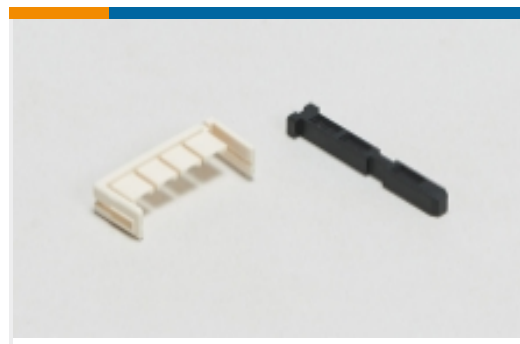

Rectangular Connector Keying Plugs(2)



Rectangular Connector Locking(2)



Rectangular Connector Seals(20)



Rectangular Power Connectors(283)

Customers Also Bought



TE Part #9-1827864-3
DYNAMIC 1200D REC HSG 6P X
BLACK

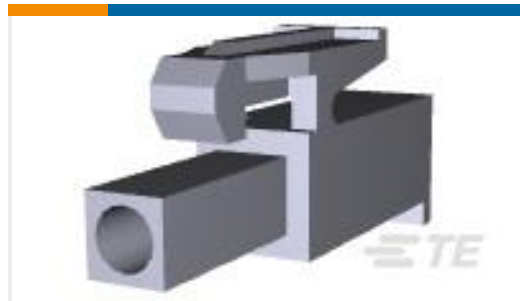

TE Part #172164-1
1 CIR UNIV M-N-L PLUG

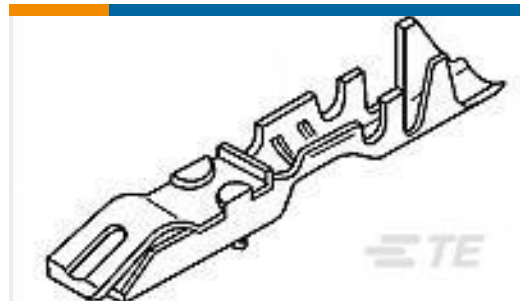

TE Part #87190-1
LOCKING CLIP CONT ASSY .025 SQ



TE Part #6-146256-0
20 MODII HDR DRST B/A .100CL L



TE Part #926209-4
2X4P LOCK-CLIP GEH

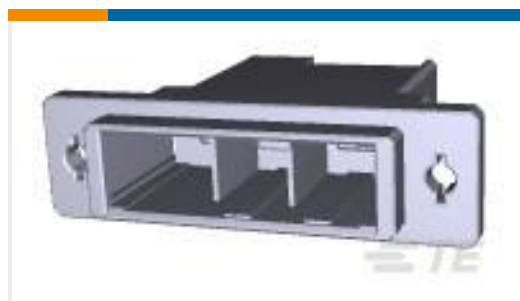

TE Part #2-353047-3
DYNAMIC D-5200S TAB HSG 3P K/Y



TE Part #9-1827862-5
DYNAMIC 1100D REC HSG 10P X
BLACK



TE Part #52465-1
TERMINAL,PG SPR SPD 16-14 10

Documents

Product Drawings

MINI UNIVERSAL M-N-L SOCKET

English

CAD Files

3D PDF

3D

Customer View Model

ENG_CVM_CVM_170362-4_N.2d_dxf.zip



English

Customer View Model

[ENG_CVM_CVM_170362-4_N.3d_igs.zip](#)

English

Customer View Model

[ENG_CVM_CVM_170362-4_N.3d_stp.zip](#)

English

By downloading the CAD file I accept and agree to the [Terms and Conditions](#) of use.

Product Specifications

[Crimping of Mini-Universal MATE-N-LOK Contact](#)

Japanese

[Application Specification](#)

Japanese

Product Environmental Compliance

[Product Compliance](#)

English

[Product Compliance](#)

English

Instruction Sheets

[Instruction Sheet \(non U.S.\)](#)

Japanese

[Mini-Universal MATE-N-LOK Connector](#)

Japanese