

172213-5 ✓ ACTIVE

TE Internal #: 172213-5

Housing, Plug, Wire-to-Board, 5 Position, 2.5 mm [.098 in]

Centerline, Crimp, 1 Row, Natural, Mating Retention, Wire & Cable,
Power & Signal

[View on TE.com >](#)



Connectors > PCB Connectors > Wire-to-Board Connectors > Wire-to-Board Connector Assemblies & Housings

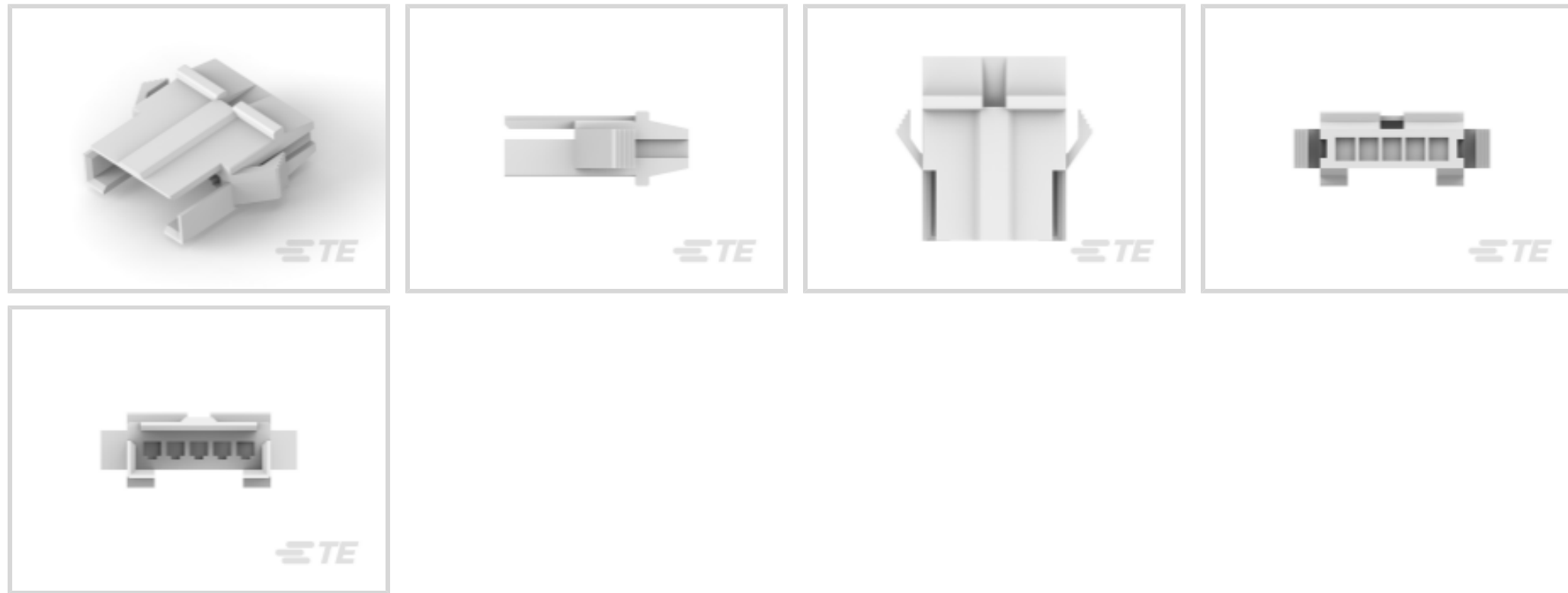

Connector Product Type: **Housing**

Connector & Housing Type: **Plug**

Connector System: **Wire-to-Board**

Number of Positions: **5**

Centerline (Pitch): **2.5 mm [.098 in]**

Features

Product Type Features

Connector Product Type	Housing
Connector & Housing Type	Plug
Connector System	Wire-to-Board
Sealable	No
Connector & Contact Terminates To	Wire & Cable

Configuration Features

Number of Positions	5
Number of Rows	1

Electrical Characteristics

Operating Voltage	250 VAC
-------------------	---------

Body Features

Connector Profile	Standard
-------------------	----------

Contact Features

Contact Layout	Inline
----------------	--------



Contact Type	Pin
--------------	-----

Contact Current Rating (Max)	2 A
------------------------------	-----

Termination Features

Termination Method to Wire & Cable	Crimp
------------------------------------	-------

Mechanical Attachment

Strain Relief	Without
---------------	---------

Panel Mount Feature	With
---------------------	------

PCB Mount Retention	Without
---------------------	---------

Mating Retention Type	Lock
-----------------------	------

Mating Retention	With
------------------	------

Connector Mounting Type	Panel Mount
-------------------------	-------------

Housing Features

Housing Material	Nylon 6/6
------------------	-----------

Centerline (Pitch)	2.5 mm [.098 in]
--------------------	------------------

Housing Color	Natural
---------------	---------

Dimensions

Connector Length	21 mm
------------------	-------

Panel Thickness (Recommended)	.81 – 1.6 mm [.032 – .063 in]
-------------------------------	-------------------------------

Connector Height	8 mm
------------------	------

Usage Conditions

Operating Temperature Range	-20 – 95 °C [-4 – 203 °F]
-----------------------------	---------------------------

Operation/Application

Circuit Application	Power & Signal
---------------------	----------------

Industry Standards

UL Flammability Rating	UL 94V-0
------------------------	----------

Agency/Standard	UL
-----------------	----

Packaging Features

Packaging Quantity	1000
--------------------	------

Packaging Method	Bag
------------------	-----

Product Compliance

[For compliance documentation, visit the product page on TE.com>](#)







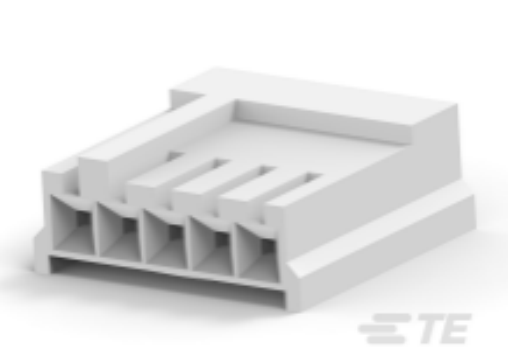
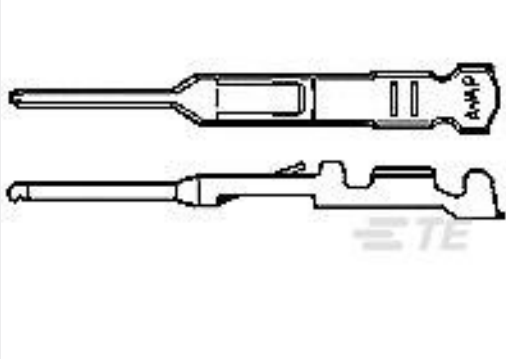

EU RoHS Directive 2011/65/EU	Compliant
EU ELV Directive 2000/53/EC	Compliant
China RoHS 2 Directive MIIT Order No 32, 2016	No Restricted Materials Above Threshold
EU REACH Regulation (EC) No. 1907/2006	Current ECHA Candidate List: JUNE 2022 (224) Candidate List Declared Against: JAN 2022 (223) SVHC > Threshold: Not Yet Reviewed
Halogen Content	Low Halogen - Br, Cl, F, I < 900 ppm per homogenous material. Also BFR/CFR/PVC Free
Solder Process Capability	Not applicable for solder process capability

Product Compliance Disclaimer

This information is provided based on reasonable inquiry of our suppliers and represents our current actual knowledge based on the information they provided. This information is subject to change. The part numbers that TE has identified as EU RoHS compliant have a maximum concentration of 0.1% by weight in homogenous materials for lead, hexavalent chromium, mercury, PBB, PBDE, DBP, BBP, DEHP, DIBP, and 0.01% for cadmium, or qualify for an exemption to these limits as defined in the Annexes of Directive 2011/65/EU (RoHS2). Finished electrical and electronic equipment products will be CE marked as required by Directive 2011/65/EU. Components may not be CE marked. Additionally, the part numbers that TE has identified as EU ELV compliant have a maximum concentration of 0.1% by weight in homogenous materials for lead, hexavalent chromium, and mercury, and 0.01% for cadmium, or qualify for an exemption to these limits as defined in the Annexes of Directive 2000/53/EC (ELV). Regarding the REACH Regulation, the information TE provides on SVHC in articles for this part number is based on the latest European Chemicals Agency (ECHA) 'Guidance on requirements for substances in articles' posted at this URL: <https://echa.europa.eu/guidance-documents/guidance-on-reach>

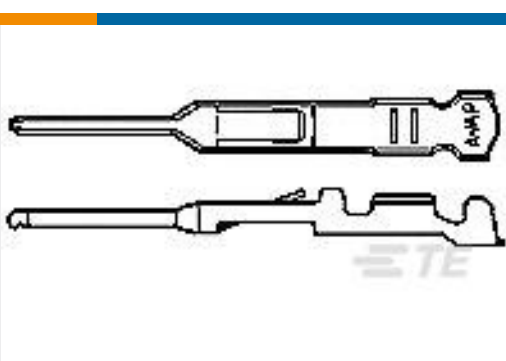
Compatible Parts

 <p>TE Part # 171822-5 EIS REC. HSG 5P-NATURAL</p>	 <p>TE Part # 170429-2 EIS REC CONT 26-20 AWG PHOS TN</p>	 <p>TE Part # 170429-1 EIS REC CONT 26-20 AWG BR TN</p>	 <p>TE Part # 170376-2 EI-SRS COSI CONTACT</p>
 <p>TE Part # 170376-1 AMP EI PIN CONTACT</p>	 <p>TE Part # 170377-1 EIS CONTACT</p>	 <p>TE Part # 170376-3 EIS CONN. PIN CONTACT</p>	 <p>TE Part # 170429-3 SERIE EI STIFTKONT</p>

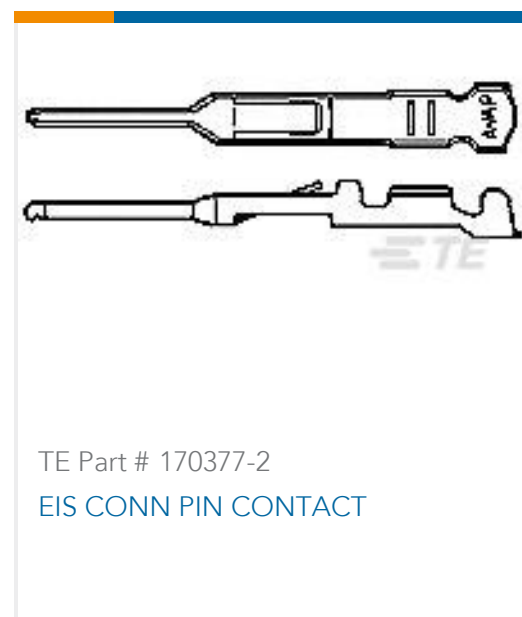

Customers Also Bought



Documents



Product Drawings

[EIS CAP HSG PANEL MOUNT 5P NATUTURAL](#)

English

CAD Files

[3D PDF](#)

3D

Customer View Model

[ENG_CVM_CVM_172213-5_F.2d_dxf.zip](#)

English

Customer View Model

[ENG_CVM_CVM_172213-5_F.3d_igs.zip](#)

English

Customer View Model

[ENG_CVM_CVM_172213-5_F.3d_stp.zip](#)

English

By downloading the CAD file I accept and agree to the [Terms and Conditions](#) of use.

Datasheets & Catalog Pages

[1-1773972-5_EIS_Connectors_Brochure](#)

English

Product Specifications

[Crimping of AMP EI Series Connector Contacts](#)

Japanese

[Application Specification](#)

Japanese

Product Environmental Compliance

[Product Compliance](#)

English

[Product Compliance](#)

English

Agency Approvals

[Agency Approval Document](#)

English