

172157-1 ✓ ACTIVE

MATE-N-LOK | Mini-Universal MATE-N-LOK

TE Internal #: 172157-1

Rectangular Power Connectors, Housing, Receptacle, Wire-to-Panel / Wire-to-Wire, 2 Position, .165 in [4.2 mm] Centerline, Mini-Universal MATE-N-LOK

[View on TE.com >](#)



Connectors > Power Connectors > Rectangular Power > Rectangular Power Connectors



Rectangular Power Connector Type: **Housing**

Connector & Housing Type: **Receptacle**

Connector System: **Wire-to-Panel, Wire-to-Wire**

Number of Positions: **2**

Centerline (Pitch): **4.2 mm [.165 in]**

Features

Product Type Features

Rectangular Power Connector Type	Housing
Connector & Housing Type	Receptacle
Connector System	Wire-to-Panel, Wire-to-Wire
Sealable	No
Connector & Contact Terminates To	Wire & Cable

Configuration Features

Number of Positions	2
Number of Rows	1

Electrical Characteristics

Operating Voltage	600 VDC
-------------------	---------

Contact Features

Contact Layout	Inline
Multiple Contact Types	Without
Contact Retention Within Housing	Without



Contact Type	Pin
--------------	-----

Termination Features

Termination Method to Wire & Cable	Crimp
------------------------------------	-------

Mechanical Attachment

Panel Mount Feature	With
---------------------	------

Panel Mount Feature Type	Mounting Ears
--------------------------	---------------

Connector Mounting Type	Panel Mount
-------------------------	-------------

Housing Features

Centerline (Pitch)	4.2 mm [.165 in]
--------------------	------------------

Housing Color	Natural
---------------	---------

Housing Material	Nylon 66
------------------	----------

Dimensions

Width	11.95 mm
-------	----------

Panel Thickness	.8 – 2 mm [.031 – .078 in]
-----------------	----------------------------

Height	11.8 mm
--------	---------

Length	23.7 mm
--------	---------

Usage Conditions

Operating Temperature Range	-20 – 105 °C [-4 – 221 °F]
-----------------------------	----------------------------

Operation/Application

Assembly Integration Feature	Without
------------------------------	---------

Circuit Application	Power & Signal
---------------------	----------------

Industry Standards

CSA Rating	Certified
------------	-----------

UL Flammability Rating	UL 94V-0
------------------------	----------

Glow Wire Rating	Standard Part - Not Glow Wire
------------------	-------------------------------

Agency/Standard Number	E28476
------------------------	--------

Agency/Standard	CSA, UL
-----------------	---------

UL Rating	Recognized
-----------	------------

CSA File Number	LR7189
-----------------	--------

VDE Tested	No
------------	----

Packaging Features



Packaging Method	Bag
------------------	-----

Packaging Quantity	500
--------------------	-----

Other

For Use With	Mini-Universal MATE-N-LOK Cap Housing
--------------	---------------------------------------

Product Compliance

[For compliance documentation, visit the product page on TE.com>](#)

EU RoHS Directive 2011/65/EU	Compliant
------------------------------	-----------

EU ELV Directive 2000/53/EC	Compliant
-----------------------------	-----------

China RoHS 2 Directive MIIT Order No 32, 2016	No Restricted Materials Above Threshold
---	---

EU REACH Regulation (EC) No. 1907/2006	Current ECHA Candidate List: JUNE 2022 (224) Candidate List Declared Against: JAN 2022 (223) SVHC > Threshold: Not Yet Reviewed
--	--

Halogen Content	Low Halogen - Br, Cl, F, I < 900 ppm per homogenous material. Also BFR/CFR/PVC Free
-----------------	---











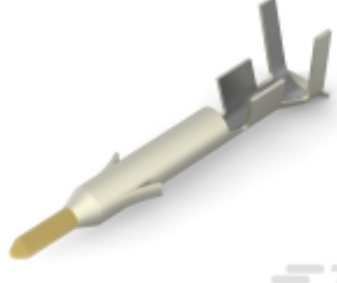
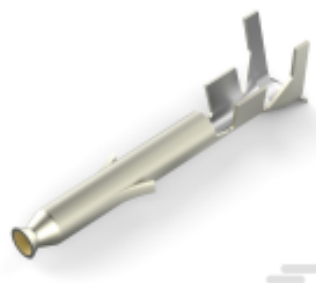

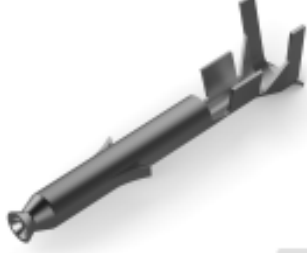

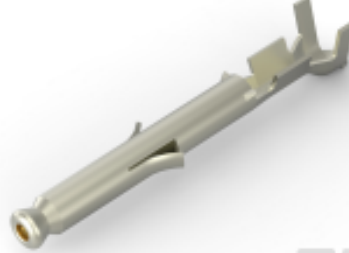
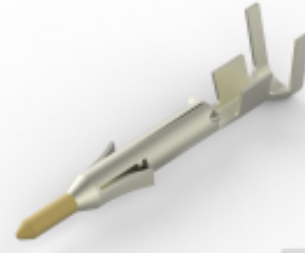
Solder Process Capability	Not applicable for solder process capability
---------------------------	--

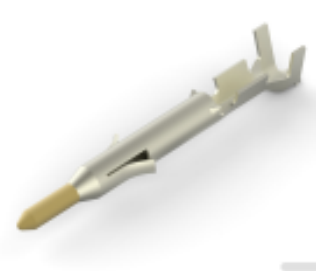
Product Compliance Disclaimer

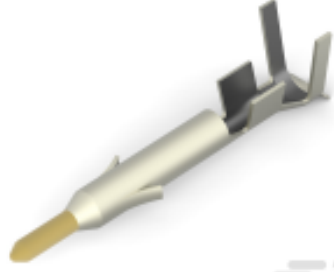
This information is provided based on reasonable inquiry of our suppliers and represents our current actual knowledge based on the information they provided. This information is subject to change. The part numbers that TE has identified as EU RoHS compliant have a maximum concentration of 0.1% by weight in homogenous materials for lead, hexavalent chromium, mercury, PBB, PBDE, DBP, BBP, DEHP, DIBP, and 0.01% for cadmium, or qualify for an exemption to these limits as defined in the Annexes of Directive 2011/65/EU (RoHS2). Finished electrical and electronic equipment products will be CE marked as required by Directive 2011/65/EU. Components may not be CE marked. Additionally, the part numbers that TE has identified as EU ELV compliant have a maximum concentration of 0.1% by weight in homogenous materials for lead, hexavalent chromium, and mercury, and 0.01% for cadmium, or qualify for an exemption to these limits as defined in the Annexes of Directive 2000/53/EC (ELV). Regarding the REACH Regulation, the information TE provides on SVHC in articles for this part number is based on the latest European Chemicals Agency (ECHA) 'Guidance on requirements for substances in articles' posted at this URL: <https://echa.europa.eu/guidance-documents/guidance-on-reach>

Compatible Parts

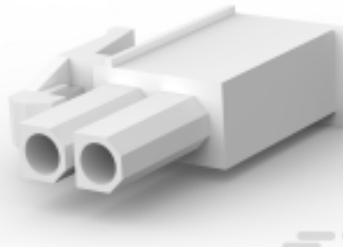

 <p>TE Part # 1-770985-0 MINI UMNL PIN 22-22AWG AU LP</p>	 <p>TE Part # 1-770987-0 MINI UMNL PIN 22-18 AWG AU LP</p>	 <p>TE Part # 770988-3 MINI UMNL SOK 22-18AWG AU LP</p>	 <p>TE Part # 1-794059-0 MINI UMNL PIN L/P LF</p>
 <p>TE Part # 770988-1 MINI UMNL SOK 22-18AWG SN LP</p>	 <p>TE Part # 770986-1 MINI UMNL SOK 26-22AWG SN LP</p>	 <p>TE Part # 170365-3 MINI UNIVERSAL M-N-L SOCKET LP</p>	 <p>TE Part # 170364-3 MINI UNIVERSAL M-N-L PIN LP</p>
 <p>TE Part # 770985-1 MINI UMNL PIN 26-22AWG SN LP</p>	 <p>TE Part # 1-794407-1 MINI UMNL SOK 20-16 AWG AU LF</p>	 <p>TE Part # 170363-3 MINI UNIVERSAL M-N-L PIN LP</p>	 <p>TE Part # 171639-1 MINI U-M-N-L SOCKET LP</p>
 <p>TE Part # 770903-3 MINI UMNL PIN 22-18 AWG AU</p>	 <p>TE Part # 170364-1 MINI UNIVERSAL M-N-L PIN LP</p>	 <p>TE Part # 1-770902-1 MINI UMNL SOK 26-22 AWG AU LF</p>	 <p>TE Part # 170366-1 MINI UNIVERSAL M-N-L SOCKET LP</p>
 <p>TE Part # 170363-1 MINI UNIVERSAL M-N-L PIN LP</p>	 <p>TE Part # 170365-1 MINI UNIVERSAL M-N-L SOCKET LP</p>	 <p>TE Part # 172165-1 2 CIR UNIV M-N-L PLUG NATL</p>	 <p>TE Part # 794406-3 MINI UMNL CONT 20-16AWG AU</p>

Also in the Series | **Mini-Universal MATE-N-LOK**



Connector Contacts(11)

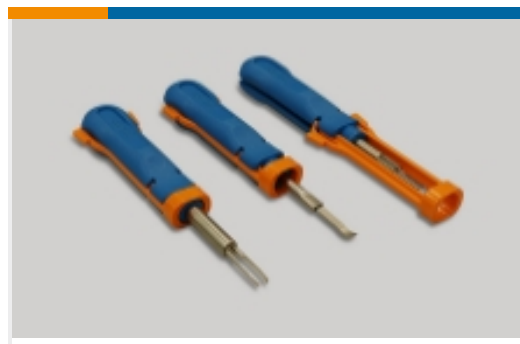

Insertion & Extraction Tools(1)

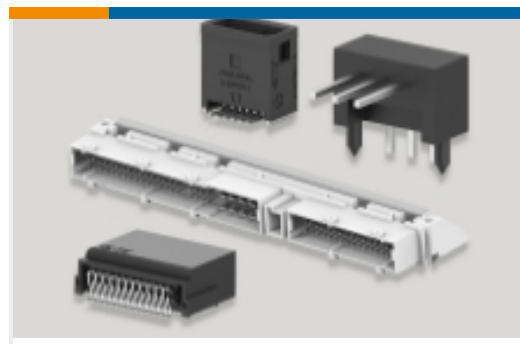

PCB Headers & Receptacles(1)

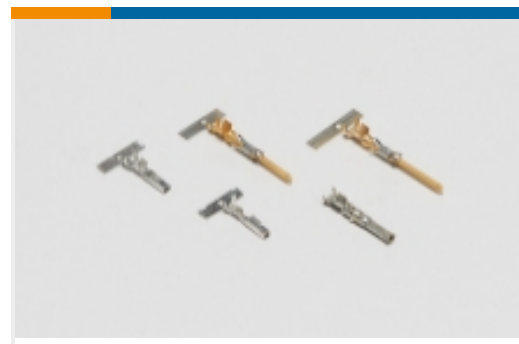

Power Contacts(85)



Rectangular Backshells & Clamps(2)

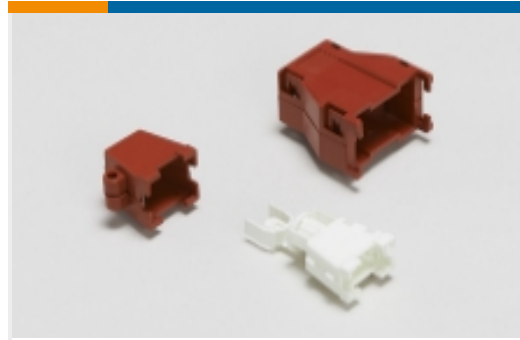

Rectangular Boots & Strain Relief(2)

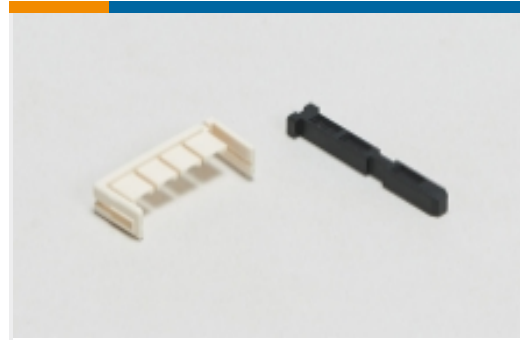

Rectangular Connector Keying Plugs(2)



Rectangular Connector Locking(2)



Rectangular Connector Seals(20)



Rectangular Power Connectors(283)

Customers Also Bought



TE Part #172170-1
12 CIR UNIV M-N-L PLUG



TE Part #172162-1
12 CIR UNIV M-N-L CAP



TE Part #172158-1
3 CIR UNIV M-N-L CAP

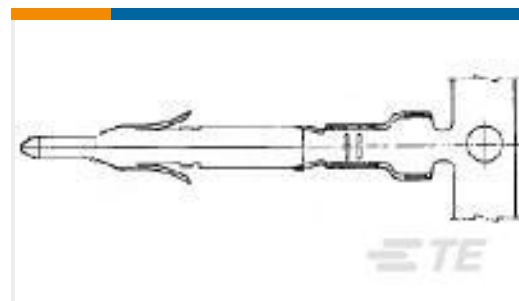

TE Part #170363-1
MINI UNIVERSAL M-N-L PIN LP



TE Part #172161-1
9 CIR UNIV M-N-L CAP

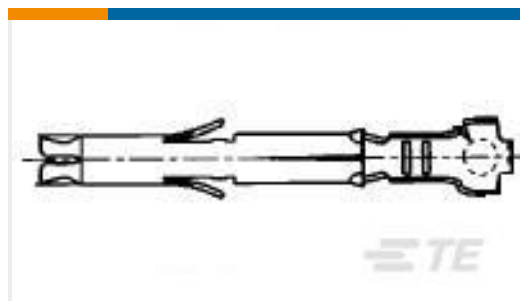

TE Part #170365-1
MINI UNIVERSAL M-N-L SOCKET LP



TE Part #172169-1
9 CIR UNIV M-N-L PLUG



TE Part #172167-1
4 CIR UNIV M-N-L PLUG



Documents

Product Drawings

[2CIR MINI U-M-N-L CAP NATL](#)

English

CAD Files

[3D PDF](#)

3D

Customer View Model

[ENG_CVM_CVM_172157-1_K.2d_dxf.zip](#)

English

Customer View Model

[ENG_CVM_CVM_172157-1_K.3d_igs.zip](#)

English

Customer View Model

[ENG_CVM_CVM_172157-1_K.3d_stp.zip](#)

English

By downloading the CAD file I accept and agree to the [Terms and Conditions](#) of use.

Datasheets & Catalog Pages

[SOFT_SHELL_PIN_AND_SOCKET_CONNECTORS_CATALOG](#)

English

[1-1773458-0_MINI_UNIVERSAL_MATE_N_LOK_CONNECTOR_SYSTEM_QRG](#)

English

Product Specifications

[Application Specification](#)

English

Product Environmental Compliance

[MD_172157-1_06142018142_dmtec](#)

English

[MD_172157-1_06142018142_dmtec](#)

English

Instruction Sheets

[Instruction Sheet \(U.S.\)](#)



English

[Agency Approvals](#)

[Agency Approval Document](#)

English

[Agency Approval Document](#)

English