

175022-1 ✓ ACTIVE

Positive Lock | Positive Lock 250

TE Internal #: 175022-1

Quick Disconnects, Receptacle, 18 – 14 AWG Wire Size, .82 – 2.08 mm² Wire Size, Mating Tab Width .25 in [6.35 mm], Straight, Brass, Positive Lock 250

[View on TE.com >](#)



Terminals & Splices > Quick Disconnects



Quick Disconnect Terminal Type: **Receptacle**

Wire Size: .82 – 2.08 mm²

Mating Tab Width: 6.35 mm [.25 in]

Mating Tab Thickness: .81 mm [.032 in]

Features

Product Type Features

Terminates To	Wire & Cable
Wire Stop	No
Wire/Cable Type	Regular Wire
Sealable	No

Configuration Features

Connection Capacity	Single
---------------------	--------

Electrical Characteristics

Voltage (Max)	250 V
---------------	-------

Contact Features

Quick Disconnect Terminal Type	Receptacle
Mating Tab Width	6.35 mm [.25 in]
Mating Tab Thickness	.81 mm [.032 in]
Terminal Orientation	Straight
Contact Base Material	Brass



Terminal Plating Material	Pre-Tin
---------------------------	---------

Crimp Type	F-Crimp
------------	---------

Barrel Type	Open
-------------	------

Mechanical Attachment

Wire Insulation Support	With
-------------------------	------

Dimensions

Accepts Wire Insulation Diameter Range	2.2 – 3.4 mm [.086 – .133 in]
--	-------------------------------

Overall Length	21.2 mm [.834 in]
----------------	-------------------

Receptacle Terminal Stock Thickness	.41 mm [.016 in]
-------------------------------------	------------------

Wire Size	.82 – 2.08 mm ²
-----------	----------------------------

Usage Conditions

Insulation Option	Fully Insulated
-------------------	-----------------

Operating Temperature Range	-40 – 110 °C [-40 – 230 °F]
-----------------------------	-----------------------------

Packaging Features

Packaging Quantity	4500
--------------------	------

Packaging Method	Strip/Reel
------------------	------------

Product Compliance

[For compliance documentation, visit the product page on TE.com>](#)

EU RoHS Directive 2011/65/EU	Compliant
------------------------------	-----------

EU ELV Directive 2000/53/EC	Compliant
-----------------------------	-----------

China RoHS 2 Directive MIIT Order No 32, 2016	No Restricted Materials Above Threshold
---	---

EU REACH Regulation (EC) No. 1907/2006	Current ECHA Candidate List: JUNE 2022 (224) Candidate List Declared Against: JAN 2022 (223) SVHC > Threshold: Not Yet Reviewed
--	--

Halogen Content	Low Halogen - Br, Cl, F, I < 900 ppm per homogenous material. Also BFR/CFR/PVC Free
-----------------	---

Solder Process Capability	Not applicable for solder process capability
---------------------------	--

Product Compliance Disclaimer

This information is provided based on reasonable inquiry of our suppliers and represents our current actual knowledge based on the information they provided. This information is subject to change. The part numbers that TE has identified as EU RoHS compliant have a maximum concentration of 0.1% by weight in homogenous materials for lead, hexavalent

chromium, mercury, PBB, PBDE, DBP, BBP, DEHP, DIBP, and 0.01% for cadmium, or qualify for an exemption to these limits as defined in the Annexes of Directive 2011/65/EU (RoHS2). Finished electrical and electronic equipment products will be CE marked as required by Directive 2011/65/EU. Components may not be CE marked. Additionally, the part numbers that TE has identified as EU ELV compliant have a maximum concentration of 0.1% by weight in homogenous materials for lead, hexavalent chromium, and mercury, and 0.01% for cadmium, or qualify for an exemption to these limits as defined in the Annexes of Directive 2000/53/EC (ELV). Regarding the REACH Regulation, the information TE provides on SVHC in articles for this part number is based on the latest European Chemicals Agency (ECHA) 'Guidance on requirements for substances in articles' posted at this URL: <https://echa.europa.eu/guidance-documents/guidance-on-reach>

Compatible Parts



TE Part # CAT-P9426-P9601B
DP CONTACTORS, 3 POLE, 20-40FLA



TE Part # CAT-P9426-P9601A
DP CONTACTORS, 2 POLE



TE Part # CAT-P9426-P9601
DP CONTACTORS, 1 POLE



TE Part # CAT-P9426-P9601C
DP CONTACTORS, 4 POLE



TE Part # 5-1393252-6
W67-X2Q12-15=M6/M7/M9/W6/W7



TE Part # 3-1423675-9
W57-XB1A4A10-15=CKTBKR,THERM,P



TE Part # 3-1393250-8
W28-XQ1A-5=W28-



TE Part # 3-1393250-9
W28-XQ1A-6=W28-



TE Part # 4-1393250-0
W28-XQ1A-7=W28



TE Part # 2-1393250-5
W28-XQ1A-10=W28-



TE Part # 2-1393250-7
W28-XQ1A-12=W28



TE Part # 3-1393250-3
W28-XQ1A-20=W28



TE Part # 3-1393250-0
W28-XQ1A-15=W28



TE Part # 3-1393250-7
W28-XQ1A-4=W28-



TE Part # 4-1393250-2
W28-XQ1A-9=W28



TE Part # 2232343-1
250 PL EX FLAG REC. 18-12AWG PTBR



TE Part # 2-1393132-6
P25P42D22P1-24=CONTACTORS



TE Part # 1-1393250-9
W28-XQ1A-0.25=W28



TE Part # 2-1393250-1
W28-XQ1A-0.50=W28



TE Part # 2-1393250-2
W28-XQ1A-0.75=W28

Also in the Series | Positive Lock 250



Automotive Terminals(1)



Crimp Terminal Housings(203)



Insertion & Extraction Tools(3)



Insulation Boots & Sleeves(4)



Quick Disconnects(189)

Customers Also Bought

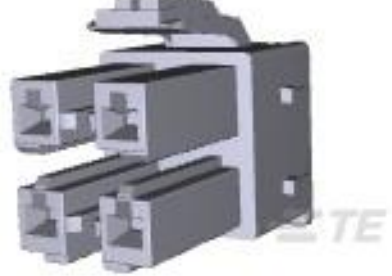

TE Part #179861-1
AMP POWER D/LOCK PLUG HSG 4P



TE Part #1-1123823-1
EP IP PLUG NATURAL



TE Part #1-176497-1
250 HSG. PL EX FLAG REC. NAT



TE Part #173722-1
187 PL EX REC. 26-20AWG PTBR



TE Part #1-1565373-1
025 28POS CAP ASSY H AU

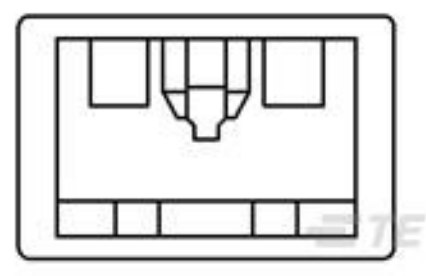

TE Part #1318954-6
250 HSG. PL EX REC. BLUE



TE Part #2232111-3
250 FASTON, FLAG, REC., 12-20 AWG, TPBR



TE Part #1217133-4
187 FASTON, PCB TAB, TNBR

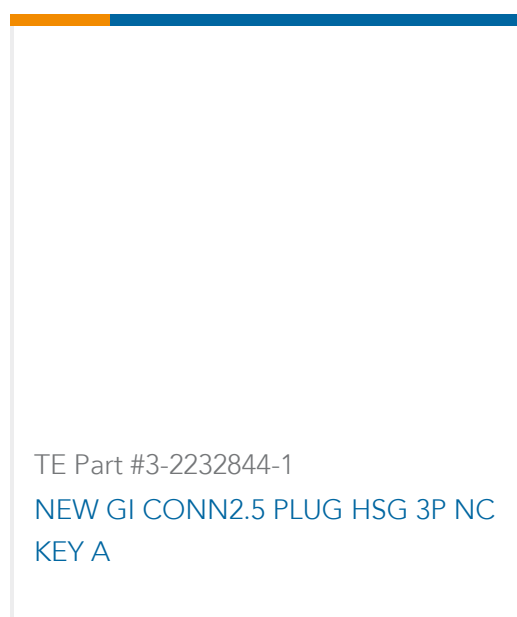

Documents

Product Drawings

[250 PL EX REC. 18-14AWG PTBR](#)

English

CAD Files

[3D PDF](#)

3D

Customer View Model

[ENG_CVM_CVM_175022-1_L_c-175022-1-l.2d_dxf.zip](#)

English

Customer View Model

[ENG_CVM_CVM_175022-1_L_c-175022-1-l.3d_igs.zip](#)

English

Customer View Model

[ENG_CVM_CVM_175022-1_L_c-175022-1-l.3d_stp.zip](#)

English

By downloading the CAD file I accept and agree to the [Terms and Conditions](#) of use.

Product Specifications

[Application Specification](#)

English

Product Environmental Compliance

[MD_175022-1_11122018846_dmtec](#)

English

[MD_175022-1_11122018846_dmtec](#)

English

Instruction Sheets

[Instruction Sheet \(non U.S.\)](#)

English

[POSITIVE LOCK EX CONTACT](#)

English

Agency Approvals

[Agency Approval Document](#)



English