



AMP | Multilock Connector System

TE Internal #: 174933-2

Housing for Female Terminals, Wire-to-Wire, 12 Position, Black, Signal, Cable Mount (Free-Hanging), Multilock Connector System

[View on TE.com >](#)

Connectors > Automotive Connectors > Connector Housings > MULTILOCK, CONNECTOR HOUSING

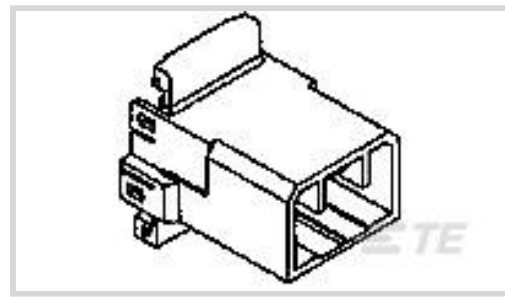

Connector & Housing Type: **Housing for Female Terminals**

Mating Tab Width: **1.8 mm [.071 in]**

Connector System: **Wire-to-Wire**

Number of Positions: **12**

Sealable: **No**

[All MULTILOCK, CONNECTOR HOUSING \(576\)](#)

Features

Product Type Features

Connector & Housing Shape	Rectangular
Connector & Housing Type	Housing for Female Terminals
Connector System	Wire-to-Wire
Sealable	No
Hybrid Connector	No

Configuration Features

Number of Positions	12
Number of Rows	2

Body Features

Body Material	PBT
Primary Product Color	Black

Contact Features

Contact Size	1.8mm
Contact Type	Receptacle
Mating Tab Width	1.8 mm[.071 in]

Mechanical Attachment

Mounting Feature	Without
------------------	---------



Terminal Position Assurance	No
Strain Relief	Without
Mating Alignment Type	Polarized
Mating Alignment	With
Connector Mounting Type	Cable Mount (Free-Hanging)

Dimensions

Product Width	18.2 mm[.717 in]
Product Length	32.7 mm[1.29 in]
Product Height	31.4 mm[1.24 in]
Row-to-Row Spacing	3 mm[.118 in]

Usage Conditions

Operating Temperature (Max)	70 °C, 75 °C, 80 °C, 85 °C, 90 °C, 100 °C, 105 °C[158 °F][167 °F][176 °F][185 °F][194 °F][212 °F][221 °F]
Operating Temperature Range	-30 – 105 °C[-22 – 221 °F]

Operation/Application

Circuit Application	Signal
---------------------	--------

Packaging Features

Packaging Quantity	50
--------------------	----

Other

Connector Position Assurance Capable	No
--------------------------------------	----

Product Compliance

[For compliance documentation, visit the product page on TE.com>](#)

EU RoHS Directive 2011/65/EU	Compliant
EU ELV Directive 2000/53/EC	Compliant
China RoHS 2 Directive MIIT Order No 32, 2016	No Restricted Materials Above Threshold
EU REACH Regulation (EC) No. 1907/2006	Current ECHA Candidate List: JUNE 2022 (224) Candidate List Declared Against: JAN 2022 (223) SVHC > Threshold: Not Yet Reviewed
Halogen Content	Low Halogen - Br, Cl, F, I < 900 ppm per homogenous material. Also BFR/CFR/PVC Free

Solder Process Capability

Not applicable for solder process capability

Product Compliance Disclaimer

This information is provided based on reasonable inquiry of our suppliers and represents our current actual knowledge based on the information they provided. This information is subject to change. The part numbers that TE has identified as EU RoHS compliant have a maximum concentration of 0.1% by weight in homogenous materials for lead, hexavalent chromium, mercury, PBB, PBDE, DBP, BBP, DEHP, DIBP, and 0.01% for cadmium, or qualify for an exemption to these limits as defined in the Annexes of Directive 2011/65/EU (RoHS2). Finished electrical and electronic equipment products will be CE marked as required by Directive 2011/65/EU. Components may not be CE marked. Additionally, the part numbers that TE has identified as EU ELV compliant have a maximum concentration of 0.1% by weight in homogenous materials for lead, hexavalent chromium, and mercury, and 0.01% for cadmium, or qualify for an exemption to these limits as defined in the Annexes of Directive 2000/53/EC (ELV). Regarding the REACH Regulation, the information TE provides on SVHC in articles for this part number is based on the latest European Chemicals Agency (ECHA) 'Guidance on requirements for substances in articles' posted at this URL: <https://echa.europa.eu/guidance-documents/guidance-on-reach>

Compatible Parts



TE Part # CAT-M9194-T273
MULTILOCK, RECEPTACLE AND TAB



TE Part # CAT-M9194-CH8172
MULTILOCK, CONNECTOR HOUSING



TE Part # 175029-1
070 TAB CONTACT L.P 24-22



TE Part # 175030-3
070 TAB CONTACT L/P

Also in the Series | Multilock Connector System



Automotive Connector Caps & Covers (16)



Automotive Connector EMC Shielding (1)



Automotive Connector Locks & Position Assurance(2)



Automotive Housings(575)



Automotive Seals & Cavity Plugs(2)



Automotive Terminals(141)



Insertion & Extraction Tools(6)



Other Automotive Connector Accessories(9)



PCB Headers & Receptacles(129)

Customers Also Bought

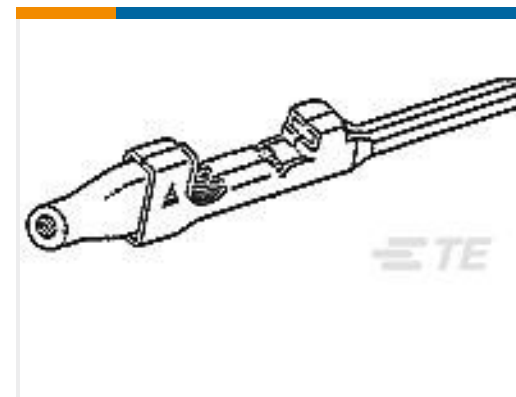
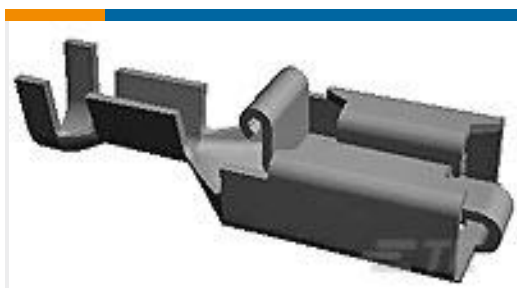
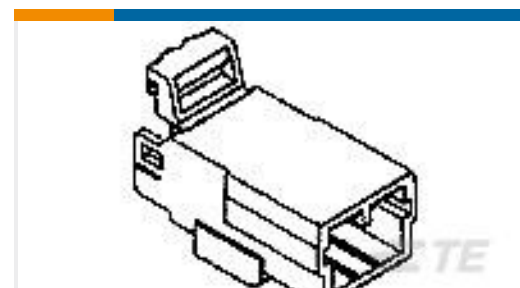
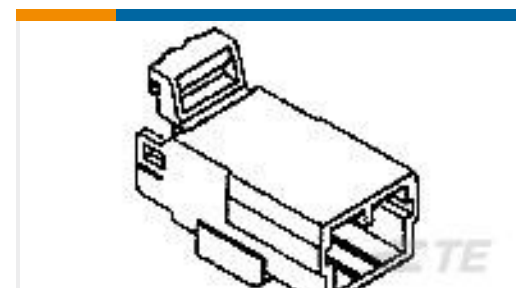
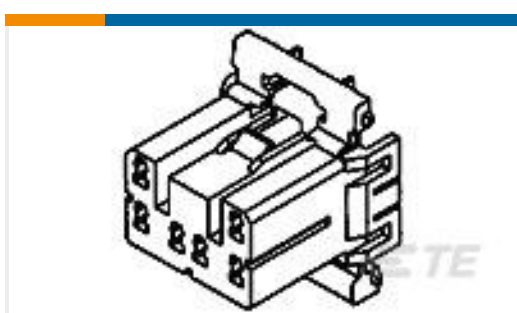
TE Part #2822352-1
070 TYPE RUBBER PLUGTE Part #929941-3
TIMER, RECEPTACLE AND TABTE Part #173682-1
040 MLC TAB CONTACTTE Part #1534594-1
MCON 1.2 CB REC SRC SNTE Part #160759-3
250 PL MKI REC. 20-15AWG TPBRTE Part #174930-2
070 MLC W-W CAP HSG 6P BLACKTE Part #174928-2
070 MLC W-W CAP HSG 3P BLACKTE Part #2112758-1
COVERTE Part #173851-2
070 MLC PLG 12P B

Documents

Product Drawings

[070 MLC W-W CAP HSG 12P B](#)

English

CAD Files

[3D PDF](#)

3D

[Customer View Model](#)

[ENG_CVM_CVM_174933-2_K.2d_dxf.zip](#)



English

Customer View Model

[ENG_CVM_CVM_174933-2_K.3d_igs.zip](#)

English

Customer View Model

[ENG_CVM_CVM_174933-2_K.3d_stp.zip](#)

English

By downloading the CAD file I accept and agree to the [Terms and Conditions](#) of use.

Datasheets & Catalog Pages

[MULTILOCK Connector System](#)

English

Product Specifications

[Product Specification](#)

Japanese