

172779-1 ✓ ACTIVE

AMP | Mark II

TE Internal #: 172779-1

Automotive Terminals, Tab, Mating Tab Width 3 mm [.118 in], Tab

Thickness .025 in [.65 mm], 22 – 18 AWG Wire Size, .3 – .85 mm²

Wire Size, Mark II

[View on TE.com >](#)



Terminals & Splices > Automotive Terminals

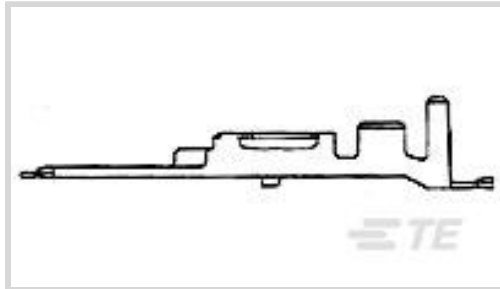

Terminal Type: **Tab**

Mating Tab Width: **3 mm [.118 in]**

Mating Tab Thickness: **.65 mm [.025 in]**

Terminal Transmits: **0 – 24 A (Low Power)**

Wire Size: **22 – 18 AWG**

Features

Product Type Features

Sealable	No
----------	----

Contact Features

Contact Size	3mm
Contact Fabrication	Stamped & Formed
Crimp Type	F-Crimp
Terminal Type	Tab
Mating Tab Width	3 mm[.118 in]
Mating Tab Thickness	.65 mm[.025 in]
Interface Plating	Tin (Sn)
Contact Termination Area Plating Material	Tin (Sn)

Termination Features

Termination Method to Wire & Cable	Crimp
Product Terminates To	Wire

Dimensions

Wire Size	.3 – .85 mm ²
Wire Size Search	18 AWG, 19 AWG, 20 AWG, 21 AWG, 22 AWG
Wire Insulation Diameter	1.5 – 2.6 mm[.059 – .102 in]



Usage Conditions

Insulation Option	Uninsulated
Operating Temperature (Max)	80 °C, 85 °C, 90 °C, 100 °C, 105 °C [176 °F] [185 °F][194 °F][212 °F][221 °F]
Operating Temperature Range	-30 – 105 °C [-22 – 221 °F]

Packaging Features

Packaging Method	Reel
Packaging Quantity	5000

Other

Terminal Transmits	0 – 24 A (Low Power)
--------------------	----------------------

Product Compliance

[For compliance documentation, visit the product page on TE.com>](#)

EU RoHS Directive 2011/65/EU	Compliant
EU ELV Directive 2000/53/EC	Compliant
China RoHS 2 Directive MIIT Order No 32, 2016	No Restricted Materials Above Threshold
EU REACH Regulation (EC) No. 1907/2006	Current ECHA Candidate List: JUNE 2022 (224) Candidate List Declared Against: JAN 2022 (223) SVHC > Threshold: Not Yet Reviewed
Halogen Content	Low Halogen - Br, Cl, F, I < 900 ppm per homogenous material. Also BFR/CFR/PVC Free
Solder Process Capability	Not applicable for solder process capability

Product Compliance Disclaimer

This information is provided based on reasonable inquiry of our suppliers and represents our current actual knowledge based on the information they provided. This information is subject to change. The part numbers that TE has identified as EU RoHS compliant have a maximum concentration of 0.1% by weight in homogenous materials for lead, hexavalent chromium, mercury, PBB, PBDE, DBP, BBP, DEHP, DIBP, and 0.01% for cadmium, or qualify for an exemption to these limits as defined in the Annexes of Directive 2011/65/EU (RoHS2). Finished electrical and electronic equipment products will be CE marked as required by Directive 2011/65/EU. Components may not be CE marked. Additionally, the part numbers that TE has identified as EU ELV compliant have a maximum concentration of 0.1% by weight in homogenous materials for lead, hexavalent chromium, and mercury, and 0.01% for cadmium, or qualify for an exemption to these limits as defined in the Annexes of Directive 2000/53/EC (ELV). Regarding the REACH Regulation, the information TE provides on SVHC in articles for this part number is based on the latest European Chemicals Agency (ECHA) 'Guidance on requirements for substances in articles' posted at this URL: <https://echa.europa.eu/guidance-documents/guidance-on-reach>

Compatible Parts

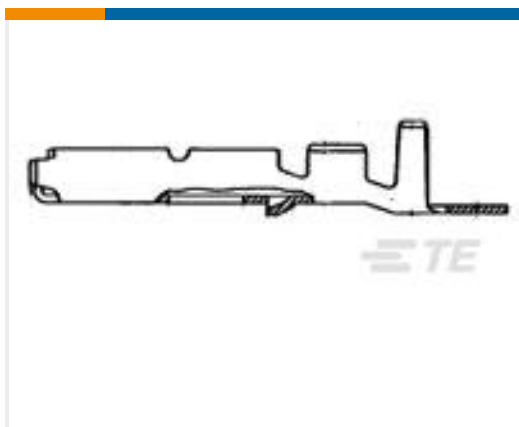
TE Part # 172775-1
MIC MK-2 REC B TYPE



TE Part # 2-2150855-2
OC-PA-E-FA-070F130F-001-0217



TE Part # 2150855-2
OC-AT-E-FA-070F130F-001-0217



TE Part # 7-2150855-7
OC-070F130F-CRIMPTOOLINGKIT

Also in the Series | **Mark II**



Automotive Housings(5)

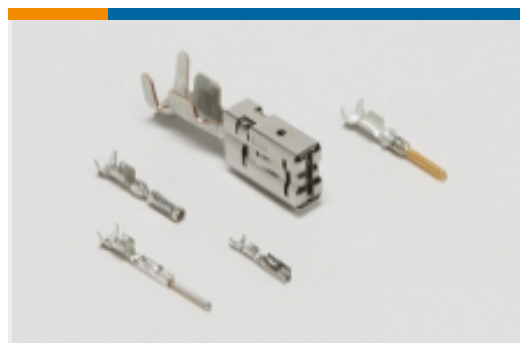

Automotive Terminals(22)



Insertion & Extraction Tools(2)

Customers Also Bought



TE Part #1-178128-5
DYNAMIC 3200 REC HSG 5P X



TE Part #170887-3
IS SHUR PLG 5 DIA NAT



TE Part #2-2138650-1
2POS MQS REC COD B



TE Part #170286-1
MIC REC CONTACT



TE Part #172776-1
MIC MARK-2 REC CONTACT L.P



TE Part #2-963748-1
TAB 2.8x0.8 CONTACT CF SWS Sn (LP)



TE Part #172505-1
MIC CAP HSG 7P MK II



TE Part #172495-1
MIC MK-II PLUG HSG 7P NATURAL

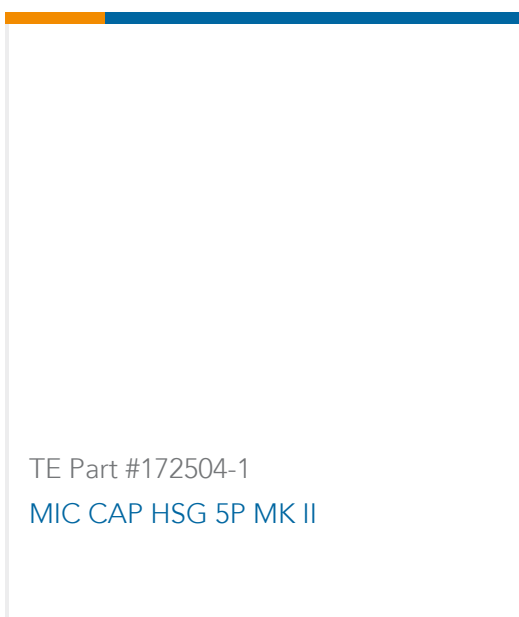

TE Part #172504-1
MIC CAP HSG 5P MK II

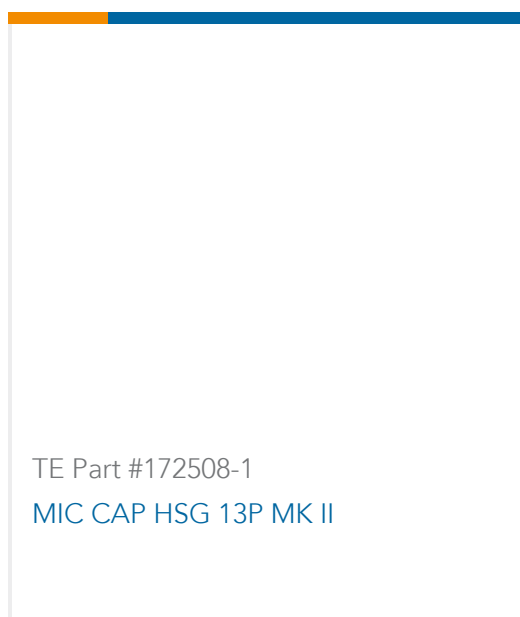

TE Part #172508-1
MIC CAP HSG 13P MK II



Documents

Product Drawings

MIC MARK-2 TAB CONTACT

English

CAD Files

Customer View Model

[ENG_CVM_172779-1_C.3d_igs.zip](#)

English

Customer View Model

[ENG_CVM_172779-1_C.3d_stp.zip](#)

English

Customer View Model

[ENG_CVM_172779-1_C.2d_dxf.zip](#)

English

3D PDF

English

By downloading the CAD file I accept and agree to the [Terms and Conditions](#) of use.

Product Specifications

Application Specification

English

Crimping Multi-Interlock (MIC) Connector Mark II, Tab Contact

English

Instruction Sheets

Instruction Sheet (non U.S.)

English

Multi-Interlock Mark II Contact From Plug & Cap HSG

English