

171636-1 ✓ ACTIVE

MATE-N-LOK | Mini-Universal MATE-N-LOK

TE Internal #: 171636-1

Power Contacts, Contact, 600 VAC, 600 VDC, Pre-Tin, 20 – 16 AWG

Wire Size, .5 – 1.3 mm² Wire Size, Wire-to-Wire, Mini-Universal

MATE-N-LOK

[View on TE.com >](#)



Connectors > Power Connectors > Power Contacts

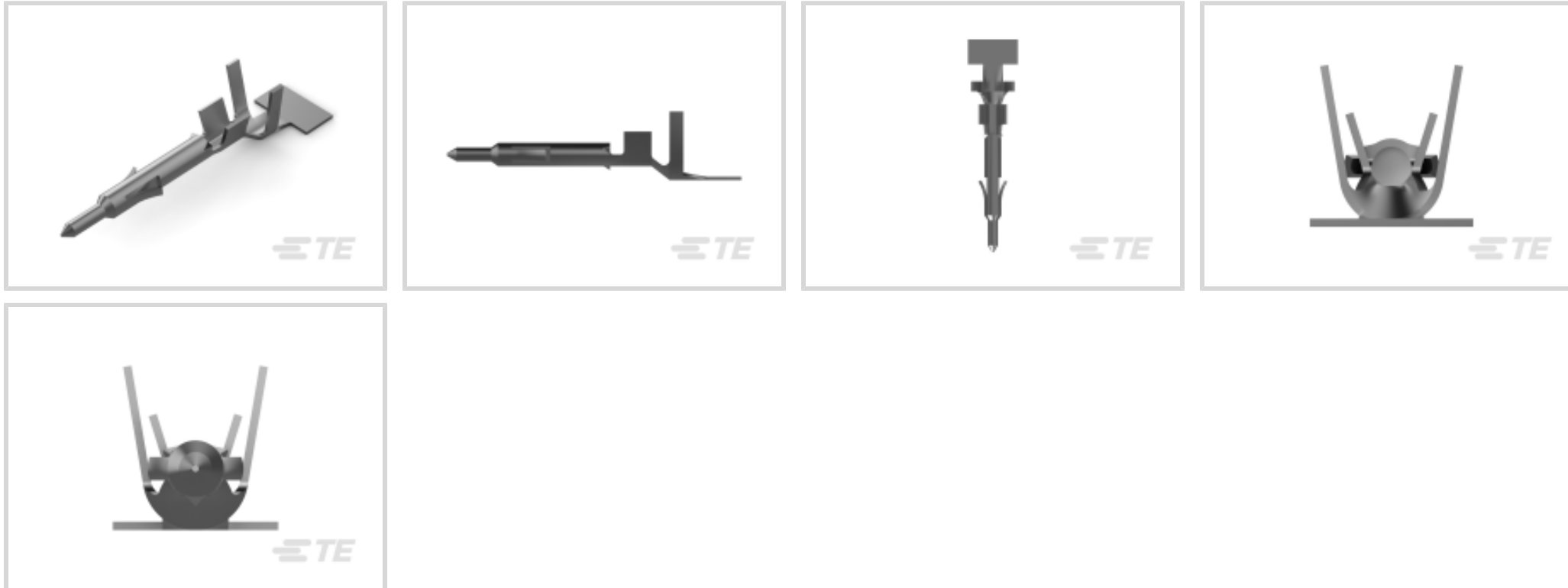

Power Contact Type: **Contact**

Operating Voltage: **600 VDC**

Contact Mating Area Plating Material: **Pre-Tin**

Wire Size: **20 – 16 AWG**

Features

Product Type Features

Power Contact Type	Contact
Connector System	Wire-to-Wire
Connector & Contact Terminates To	Wire & Cable

Electrical Characteristics

Operating Voltage	600 VDC
-------------------	---------

Contact Features

Contact Shape & Form	Square
Contact Mating Area Plating Material	Pre-Tin
Contact Current Rating (Max)	7 A
Contact Type	Pin
Contact Retention Within Housing	With
Mating Pin Diameter	1 mm[.039 in]
Contact Base Material	Brass
Contact Mating Area Plating Material Thickness	.8 μm[31.49 μin]
Wire Contact Termination Area Plating Thickness	.8 μm[31.49 μin]



Wire Contact Termination Area Plating Material	Pre-Tin
Wire Contact Termination Area Plating Material Finish	Matte
Contact Orientation	Straight
Barrel Type	Open Barrel

Termination Features

Termination Method to Wire & Cable	Crimp
------------------------------------	-------

Mechanical Attachment

Connector Mounting Type	Cable Mount (Free-Hanging)
Wire Insulation Support	Without

Dimensions

Wire Size	.5 – 1.3 mm ²
Accepts Wire Insulation Diameter Range	2 – 3.2 mm, 2.4 mm [.079 – .126 in][.094 in]

Usage Conditions

Operating Temperature Range	-20 – 105 °C [-4 – 221 °F]
-----------------------------	----------------------------

Operation/Application

Circuit Application	Power
---------------------	-------

Industry Standards

CSA Rating	Certified
Glow Wire Rating	Standard Part - Not Glow Wire
VDE Tested	No
Agency/Standard	CSA, UL
CSA File Number	LR 7189
UL Rating	Recognized
UL File Number	E28476

Packaging Features

Packaging Method	Reel
Packaging Quantity	4000

Other

Wire/Cable Type	Discrete Wire
Wire Type	Stranded
For Use With	Plug or Cap Housing



Comment

HDM Applicator part number ending in -1 is used on AMPOMATOR CLS Machine with T or G Terminators, -2 is used on AMP-O-LECTRIC Model K Machine, -3 is used on AMP-O-LECTRIC Model G Machine.

Product Compliance





[For compliance documentation, visit the product page on TE.com>](#)

EU RoHS Directive 2011/65/EU	Compliant
EU ELV Directive 2000/53/EC	Compliant
China RoHS 2 Directive MIIT Order No 32, 2016	No Restricted Materials Above Threshold
EU REACH Regulation (EC) No. 1907/2006	Current ECHA Candidate List: JUNE 2022 (224) Candidate List Declared Against: JAN 2022 (223) SVHC > Threshold: Not Yet Reviewed
Halogen Content	Low Halogen - Br, Cl, F, I < 900 ppm per homogenous material. Also BFR/CFR/PVC Free
Solder Process Capability	Not applicable for solder process capability

Product Compliance Disclaimer

This information is provided based on reasonable inquiry of our suppliers and represents our current actual knowledge based on the information they provided. This information is subject to change. The part numbers that TE has identified as EU RoHS compliant have a maximum concentration of 0.1% by weight in homogenous materials for lead, hexavalent chromium, mercury, PBB, PBDE, DBP, BBP, DEHP, DIBP, and 0.01% for cadmium, or qualify for an exemption to these limits as defined in the Annexes of Directive 2011/65/EU (RoHS2). Finished electrical and electronic equipment products will be CE marked as required by Directive 2011/65/EU. Components may not be CE marked. Additionally, the part numbers that TE has identified as EU ELV compliant have a maximum concentration of 0.1% by weight in homogenous materials for lead, hexavalent chromium, and mercury, and 0.01% for cadmium, or qualify for an exemption to these limits as defined in the Annexes of Directive 2000/53/EC (ELV). Regarding the REACH Regulation, the information TE provides on SVHC in articles for this part number is based on the latest European Chemicals Agency (ECHA) 'Guidance on requirements for substances in articles' posted at this URL: <https://echa.europa.eu/guidance-documents/guidance-on-reach>

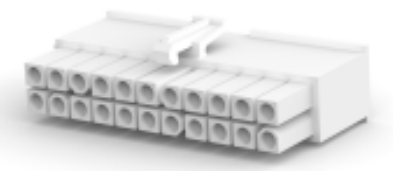
Compatible Parts

 <p>TE Part # 189727-1 EXTRACTION TOOL</p>	 <p>TE Part # 455830-1 INSERTION TOOL</p>	 <p>TE Part # 770586-1 22P MINI UMNL PLUG HSG</p>	 <p>TE Part # 770587-1 24P MINI UMNL PLUG HSG</p>
---	--	--	--



Also in the Series | Mini-Universal MATE-N-LOK

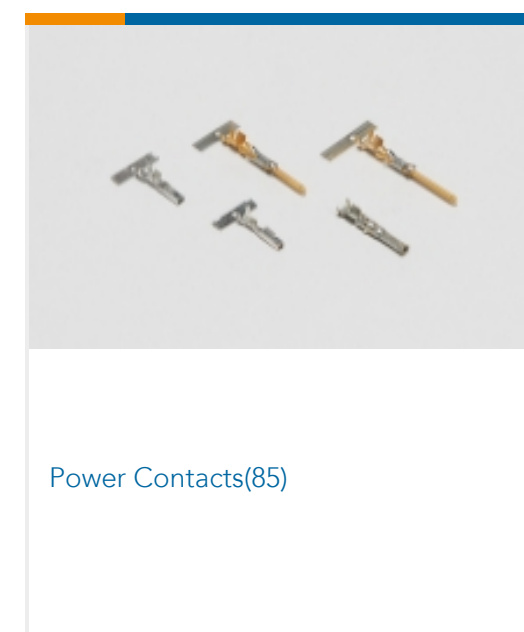
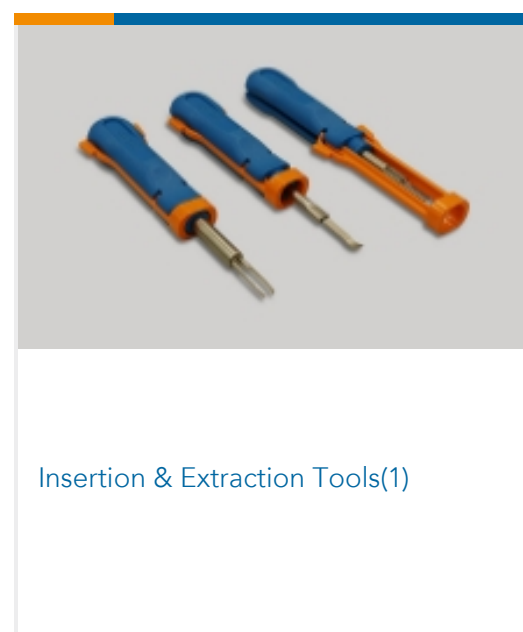
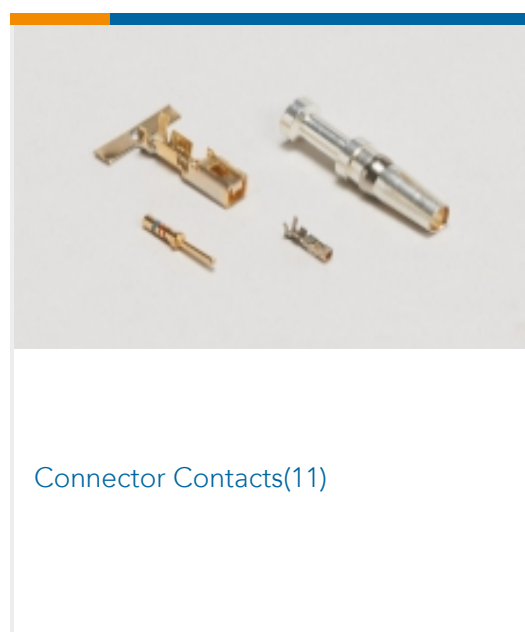



Rectangular Backshells & Clamps(2)

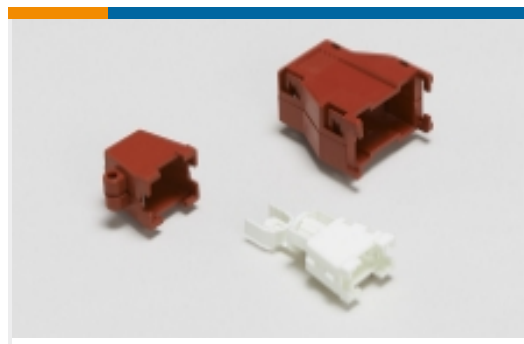

Rectangular Boots & Strain Relief(2)

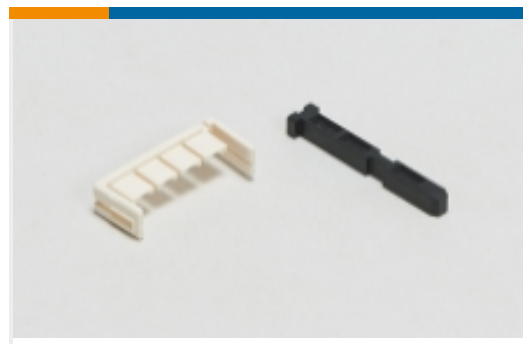

Rectangular Connector Keying Plugs(2)



Rectangular Connector Locking(2)



Rectangular Connector Seals(20)



Rectangular Power Connectors(283)

Customers Also Bought



TE Part #2016693-2
RF CA,UMCC1 TO RPSMA JACK,1.13 MM,L100MM



TE Part #2-456404-5
CRIMPER, WIRE .070

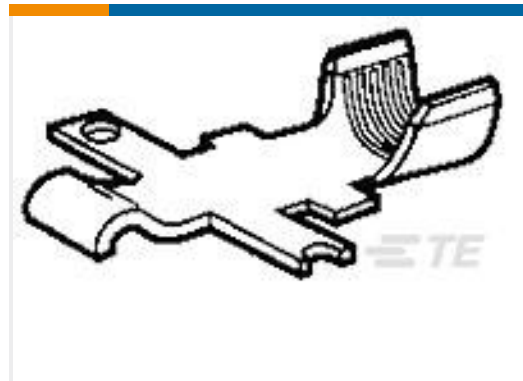

TE Part #53880-2
CONTACT,PWR LK,SRS2,STRIP,CRMP

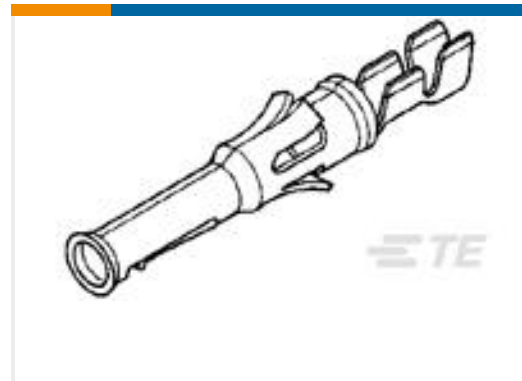

TE Part #66582-2
TYPE VI SKT CONT,MULTI-MATE

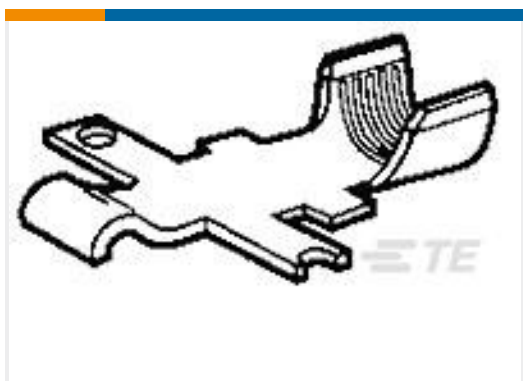

TE Part #53892-2
CONTACT,PWR LK,SRS1,STRIP,CRMP



TE Part #1-172165-6
2CIR MINI U-M-N-L PLUG BLUE



TE Part #EP26656001
DWFR-8/2-0-190MM



TE Part #EP54546001
DWFR-8/2-0-368MM

Documents

Product Drawings

[MINI U-M-N-L PIN CONTACT](#)

English

CAD Files

[Customer View Model](#)

[ENG_CVM_CVM_171636-1_D.2d_dxf.zip](#)

English

[3D PDF](#)



3D

Customer View Model

[ENG_CVM_CVM_171636-1_D.3d_igs.zip](#)

English

Customer View Model

[ENG_CVM_CVM_171636-1_D.3d_stp.zip](#)

English

By downloading the CAD file I accept and agree to the [Terms and Conditions](#) of use.

Datasheets & Catalog Pages

[SOFT_SHELL_PIN_SOCKET_CONNECTORS_STANDARD_DENSITY](#)

English

Product Specifications

[Crimping of Mini-Universal MATE-N-LOK Contact](#)

Japanese

[Application Specification](#)

Japanese

Product Environmental Compliance

[MD_171636-1_12082017139_dmtec](#)

English

[MD_171636-1_12082017139_dmtec](#)

English

Instruction Sheets

[Instruction Sheet \(non U.S.\)](#)

English

[MINI UNIVERSAL MATE-N-LOK CONNECTOR](#)

English