

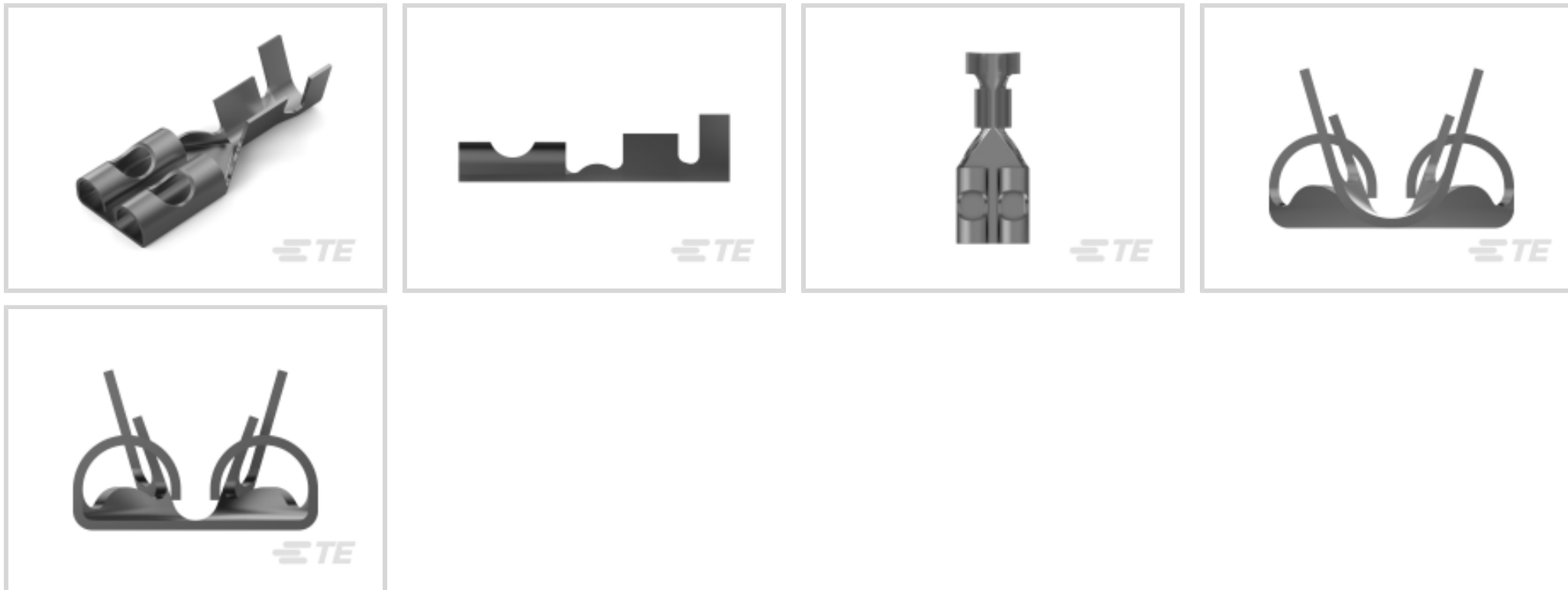

Terminals & Splices > Quick Disconnects



Quick Disconnect Terminal Type: **Receptacle**

Wire Size: .51 – 2.08 mm²

Mating Tab Width: 6.35 mm [.25 in]

Mating Tab Thickness: .61 mm [.024 in]

Features

Product Type Features

Terminates To	Wire & Cable
Wire Stop	No
Wire/Cable Type	Regular Wire
Insertion Force	Normal
Sealable	No

Configuration Features

Connection Capacity	Single
---------------------	--------

Contact Features

Quick Disconnect Terminal Type	Receptacle
Mating Tab Width	6.35 mm [.25 in]
Mating Tab Thickness	.61 mm [.024 in]
Terminal Orientation	Straight
Contact Base Material	Brass
Terminal Plating Material	Tin
Crimp Type	F-Crimp



Barrel Type	Open
-------------	------

Mechanical Attachment

Extraction Force	4.9 – 39.2 Newton
Wire Insulation Support	With

Dimensions

Accepts Wire Insulation Diameter Range	2.21 – 3.4 mm [.087 – .134 in]
Overall Length	19.6 mm [.77 in]
Receptacle Terminal Stock Thickness	.3 mm [.012 in]
Wire Size	.51 – 2.08 mm ²

Usage Conditions

Insulation Option	Uninsulated
Operating Temperature Range	-40 – 110 °C [-40 – 230 °F]

Packaging Features

Packaging Quantity	4000
Packaging Method	Strip/Reel

Other

Line	FASTON .250
------	-------------

Product Compliance

[For compliance documentation, visit the product page on TE.com>](#)

EU RoHS Directive 2011/65/EU	Compliant
EU ELV Directive 2000/53/EC	Compliant
China RoHS 2 Directive MIIT Order No 32, 2016	No Restricted Materials Above Threshold
EU REACH Regulation (EC) No. 1907/2006	Current ECHA Candidate List: JUNE 2022 (224) Candidate List Declared Against: JAN 2022 (223) SVHC > Threshold: Not Yet Reviewed
Halogen Content	Low Halogen - Br, Cl, F, I < 900 ppm per homogenous material. Also BFR/CFR/PVC Free
Solder Process Capability	Not applicable for solder process capability

Product Compliance Disclaimer

This information is provided based on reasonable inquiry of our suppliers and represents our current actual knowledge based on the information they provided. This information is subject to change. The part numbers that TE has identified as EU RoHS compliant have a maximum concentration of 0.1% by weight in homogenous materials for lead, hexavalent chromium, mercury, PBB, PBDE, DBP, BBP, DEHP, DIBP, and 0.01% for cadmium, or qualify for an exemption to these limits as defined in the Annexes of Directive 2011/65/EU (RoHS2). Finished electrical and electronic equipment products will be CE marked as required by Directive 2011/65/EU. Components may not be CE marked. Additionally, the part numbers that TE has identified as EU ELV compliant have a maximum concentration of 0.1% by weight in homogenous materials for lead, hexavalent chromium, and mercury, and 0.01% for cadmium, or qualify for an exemption to these limits as defined in the Annexes of Directive 2000/53/EC (ELV). Regarding the REACH Regulation, the information TE provides on SVHC in articles for this part number is based on the latest European Chemicals Agency (ECHA) 'Guidance on requirements for substances in articles' posted at this URL: <https://echa.europa.eu/guidance-documents/guidance-on-reach>

Compatible Parts



TE Part # 2-2150034-1
OCEAN_2.0_APPLICATOR-E-110F180F



TE Part # 2150034-1
OCEAN_2.0_APPLICATOR-E-110F180F



TE Part # 7-2150034-7
OCEAN_2.0_SPARE_PART_KIT-110F180F



TE Part # 2150034-2
OCEAN_2.0_APPLICATOR-E-110F180FA

Also in the Series | FASTON 250



Compression Connectors(4)

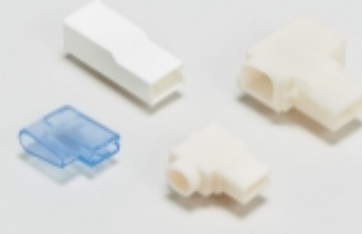

Crimp Terminal Housings(143)



Insertion & Extraction Tools(6)



Magnet Wire Terminals(1)



PCB Terminals(144)



Quick Disconnects(456)



Splices(4)

Customers Also Bought



TE Part #3-640442-5
05P MTA100 CONN ASSY BLU



TE Part #177908-1
POWER DBL LOCK CAP HSG P/M 4P

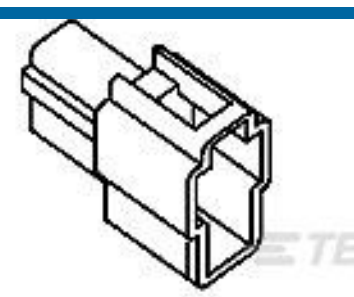

TE Part #172129-1
FF 250 PLUG HSG 2P NYLON NAT

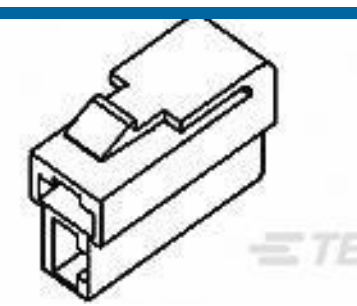

TE Part #172130-1
FF 250 REC HSG 2P NYLON NAT

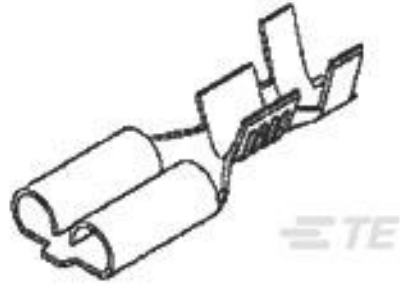

TE Part #170258-2
FF 250 REC 14-12AWG TPBR
REREELING

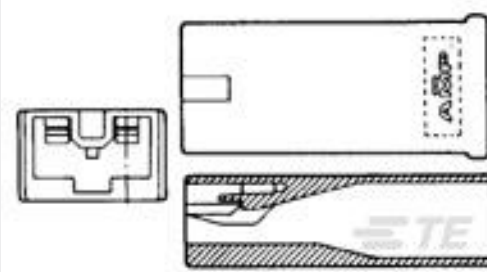

TE Part #179970-1
250 HSG. PL EX REC.



TE Part #170213-2
250 FASTON, REC., 18-14 AWG, TPBR



TE Part #170140-2
187 FASTON, FLAG, REC., 16-20 AWG,
TPBR



TE Part #179974-1
250 PL EX REC. 18-14AWG PTBR

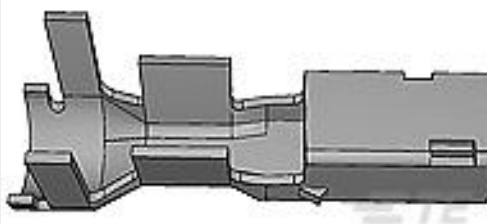

TE Part #1376347-1
5MM POWER KEY CONN REC CONT
L

Documents

Product Drawings

[250 FASTON, REC., 20-14 AWG, TPBR](#)

English

CAD Files

[3D PDF](#)

3D

Customer View Model

[ENG_CVM_CVM_170342-2_L_c-170342-2-l.2d_dxf.zip](#)

English

Customer View Model

[ENG_CVM_CVM_170342-2_L_c-170342-2-l.3d_igs.zip](#)

English

Customer View Model

[ENG_CVM_CVM_170342-2_L_c-170342-2-l.3d_stp.zip](#)

English

By downloading the CAD file I accept and agree to the [Terms and Conditions](#) of use.

Product Specifications



[Crimping of 250 Series Tab and Receptacle Contacts](#)

Japanese

[Application Specification](#)

Japanese

[Application Specification](#)

Japanese

[Crimping of 250 Series Tab and Receptacle Contacts](#)

Japanese

[Product Environmental Compliance](#)

[MD_170342-2_06202016223_dmtec](#)

English

[MD_170342-2_06202016223_dmtec](#)

English