

Printed-circuit board connector - SPC 5/ 2-STCL-7,62 - 1718481

Please be informed that the data shown in this PDF Document is generated from our Online Catalog. Please find the complete data in the user's documentation. Our General Terms of Use for Downloads are valid (<http://phoenixcontact.com/download>)

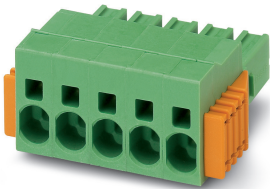

PCB connector, nominal cross section: 6 mm², color: green, nominal current: 41 A, rated voltage (III/2): 1000 V, contact surface: Tin, type of contact: Female connector, Number of potentials: 2, Number of rows: 1, Number of positions per row: 2, number of connections: 2, product range: SPC 5/..-STCL, pitch: 7.62 mm, connection method: Push-in spring connection, conductor/PCB connection direction: 0 °, Locking clip: - without locking clip, plug-in system: POWER COMBICON 5, Locking: Clip locking, type of packaging: packed in cardboard

The figure shows a 5-pos. version of the product

Your advantages

- ✓ Time saving push-in connection, tools not required
- ✓ Defined contact force ensures that contact remains stable over the long term
- ✓ Clamping space opened by means of fixed screwdriver enables convenient conductor connection
- ✓ Integrated double steel spring provides additional safety in the event of temperature and power fluctuations
- ✓ Optimized for tight installation situations: operation and conductor connection from one direction
- ✓ The automatically locking Click and Lock system prevents accidental disconnection
- ✓ 600 V UL approval in the smallest of dimensions



Key Commercial Data

Packing unit	50 pc
GTIN	
GTIN	4046356173957

Technical data

Item properties

Brief article description	PCB connector
Plug-in system	POWER COMBICON 5
Type of contact	Female connector
Range of articles	SPC 5/..-STCL
Pitch	7.62 mm
Number of positions	2
Locking	Click & Lock latching slide
Number of levels	1

Printed-circuit board connector - SPC 5/ 2-STCL-7,62 - 1718481

Technical data

Item properties

Number of connections	2
Number of potentials	2

Electrical parameters

Nominal current	41 A
Nom. voltage	1000 V
Rated voltage (III/3)	1000 V
Rated voltage (III/2)	1000 V
Rated voltage (II/2)	1000 V
Rated surge voltage (III/3)	8 kV
Rated surge voltage (III/2)	8 kV
Rated surge voltage (II/2)	6 kV

Connection capacity

Connection method	Push-in spring connection
pluggable	Yes
Conductor cross section solid	0.2 mm ² ... 10 mm ²
Conductor cross section flexible	0.2 mm ² ... 6 mm ²
Conductor cross section AWG / kcmil	24 ... 8
Conductor cross section flexible, with ferrule without plastic sleeve	0.25 mm ² ... 6 mm ²
Conductor cross section, flexible, with ferrule, with plastic sleeve	0.25 mm ² ... 4 mm ²
2 conductors with the same cross section, flexible, with TWIN ferrule with plastic sleeve	0.25 mm ² ... 1.5 mm ²
Cylindrical gauge a x b / diameter	4.3 mm x 4.0 mm / 4.0 mm
Stripping length	15 mm

Flange specifications

Type of locking	Clip locking
Mounting flange	Click & Lock latching slide

Material data - contact

Note	WEEE/RoHS-compliant, free of whiskers according to IEC 60068-2-82/ JEDEC JESD 201
Contact material	Cu alloy
Surface characteristics	hot-dip tin-plated
Metal surface terminal point (top layer)	Tin (4 - 8 µm Sn)
Metal surface contact area (top layer)	Tin (4 - 8 µm Sn)

Material data - housing

Housing color	green (6021)
Insulating material	PA
Insulating material group	I
CTI according to IEC 60112	600
Flammability rating according to UL 94	V0

Printed-circuit board connector - SPC 5/ 2-STCL-7,62 - 1718481

Technical data

Material data - housing

Glow wire flammability index GWFI according to EN 60695-2-12	850
Glow wire ignition temperature GWIT according to EN 60695-2-13	775
Temperature for the ball pressure test according to EN 60695-10-2	125 °C

Material data – actuating element

Insulating material	PA
CTI according to IEC 60112	600
Flammability rating according to UL 94	V0

Dimensions for the product

Caption	Schematische Abbildung - weitere Details siehe Produktfamilienzeichnung im Download Center
Length [l]	38.45 mm
Width [w]	23.24 mm
Height [h]	19.8 mm
Pitch	7.62 mm

Packaging information

Type of packaging	packed in cardboard
Pieces per package	50
Denomination packing units	Pcs.

General product information

Note	In accordance with IEC 61984, COMBICON connectors have no switching power (COC). During designated use, they must not be plugged in or disconnected when carrying voltage or under load.
------	--

Ambient conditions

Ambient temperature (storage/transport)	-40 °C ... 70 °C
Ambient temperature (assembly)	-5 °C ... 100 °C
Ambient temperature (operation)	-40 °C ... 100 °C (dependent on the derating curve)

Termination and connection method

Conductor connection test	The stripped-off ends of the largest conductor can be completely inserted in the opening of the terminal point without using excessive force.
Test result	Test passed
Test – repeated connection and release	IEC 60999-1:1999-11
	Test passed
Test for conductor damage and slackening	IEC 60999-1:1999-11
	Test passed

Pull-out test

Pull-out test	IEC 60999-1:1999-11
Conductor cross section / conductor type / tensile force	0.2 mm ² / solid / > 10 N
	0.2 mm ² / flexible / > 10 N

Printed-circuit board connector - SPC 5/ 2-STCL-7,62 - 1718481

Technical data

Pull-out test

	10 mm ² / solid / > 90 N
	6 mm ² / flexible / > 80 N

Mechanical tests according to standard

Test specification	IEC 61984
Visual inspection	IEC 60512-1-1:2002-02
Dimension check	IEC 60512-1-2:2002-02
Resistance of inscriptions	IEC 60068-2-70:1995-12
Insertion and withdrawal force	IEC 60512-13-2:2006-02
No. of cycles	50
Insertion strength per pos. approx.	8 N
Withdraw strength per pos. approx.	6 N
Polarization and coding	IEC 60512-13-5:2006-02
Contact holder in insert	IEC 60512-15-1:2008-05
Test force per pos.	34 N

Air clearances and creepage distances

Clearances and creepage distances	IEC 60664-1:2007-04
Specification	IEC 60664-1:2007-04
Minimum clearance - inhomogeneous field (III/3)	8 mm
Minimum clearance - inhomogeneous field (III/2)	8 mm
Minimum clearance - inhomogeneous field (II/2)	5.5 mm
Minimum creepage distance value (III/3)	12.5 mm
Minimum creepage distance value (III/2)	8 mm
Minimum creepage distance value (II/2)	5.5 mm

Electrical tests - Function

Specification	IEC 60999-1:1999-11
---------------	---------------------

Temperature cycles

Specification	IEC 60999-1:1999-11
---------------	---------------------

Current carrying capacity / derating curves

Caption	Type: SPC 5/...-STCL-7,62 with PC 5/...-GSF-7,62
---------	--

Mechanical tests (A)

Test specification	IEC 61984
Insertion strength per pos. approx.	8 N
Withdraw strength per pos. approx.	6 N
Polarization when inserted requirement >20 N	Test passed
Contact holder in insert requirements >20 N	Test passed

Durability tests (B)

Specification	IEC 60512-9-1:2010-03
Contact resistance R ₁	0.8 mΩ

Printed-circuit board connector - SPC 5/ 2-STCL-7,62 - 1718481

Technical data

Durability tests (B)

Insertion/withdrawal cycles	50
Contact resistance R_2	0.8 m Ω
Impulse withstand voltage at sea level	7.3 kV

Thermal tests (C)

Specification	IEC 60512-5-1:2002-02
Number of positions	12
Upper limiting temperature requirements <100 °C	Test passed

Climatic tests (D)

Specification	ISO 6988:1985-02
Cold stress	-40 °C/2 h
Thermal stress	100 °C/168 h
Corrosive stress	0.2 dm ³ SO ₂ on 300 dm ³ /40 °C/1 cycle
Impulse withstand voltage at sea level	7.3 kV
Power-frequency withstand voltage	3.31 kV

Environmental and durability tests (E)

Specification	IEC 61984:2008-10
Result, degree of protection, IP code	Finger safety with IP20 test finger

Environmental Product Compliance

China RoHS	Environmentally friendly use period: unlimited = EFUP-e
	No hazardous substances above threshold values

Drawings

Diagram

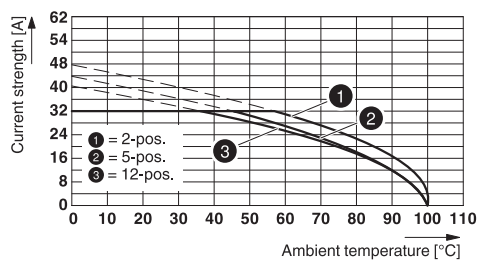

Diagram

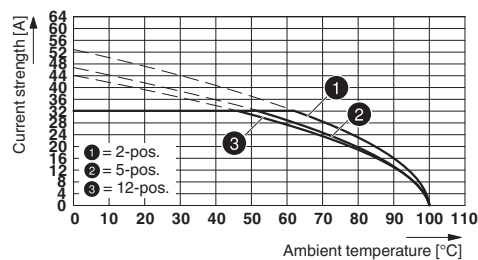

Type: SPC 5/...-STCL-7,62 with PC 5/...-GSF-7,62

Type: SPC 5/...-STCL-7,62 with ISPC 5/...-STGCL-7,62

Printed-circuit board connector - SPC 5/ 2-STCL-7,62 - 1718481

Schematic diagram

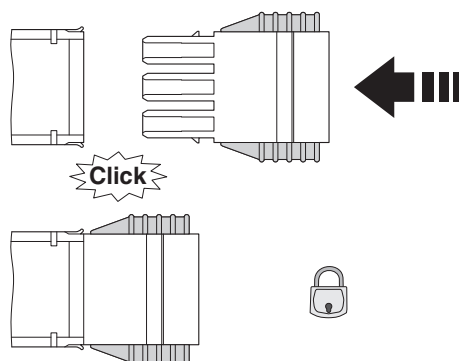

Dimensional drawing

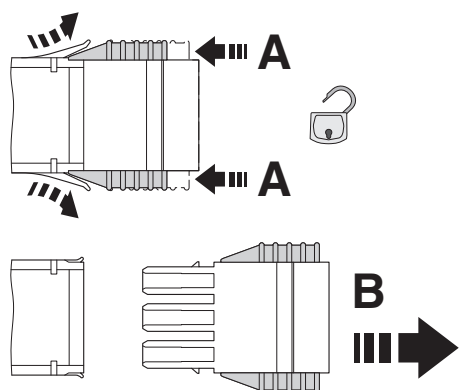
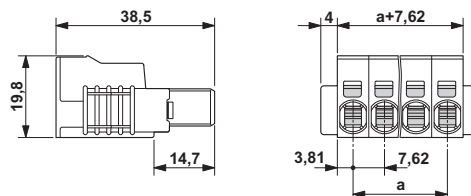

Click and Lock system method of operation

Diagram

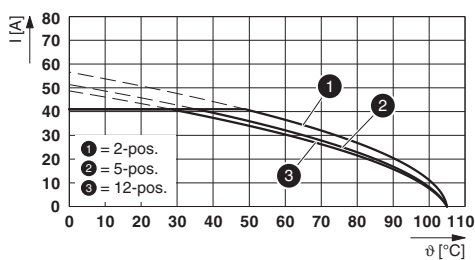

Type: SPC 5/...-STCL-7,62 with IPC 5/...-STGCL-7,62

Classifications

eCl@ss

eCl@ss 10.0.1	27440309
eCl@ss 11.0	27460202
eCl@ss 4.0	27260700
eCl@ss 4.1	27260700
eCl@ss 5.0	27260700

Printed-circuit board connector - SPC 5/ 2-STCL-7,62 - 1718481

Classifications

eCl@ss

eCl@ss 5.1	27260700
eCl@ss 6.0	27260700
eCl@ss 7.0	27440309
eCl@ss 9.0	27440309

ETIM

ETIM 3.0	EC001121
ETIM 4.0	EC002638
ETIM 6.0	EC002638
ETIM 7.0	EC002638

UNSPSC

UNSPSC 6.01	30211810
UNSPSC 7.0901	39121409
UNSPSC 11	39121409
UNSPSC 12.01	39121409
UNSPSC 13.2	39121409
UNSPSC 18.0	39121409
UNSPSC 19.0	39121409
UNSPSC 20.0	39121409
UNSPSC 21.0	39121409

Approvals

Approvals

Approvals

EAC / cULus Recognized

Ex Approvals

Approval details

EAC		B.01687
-----	--	---------

Printed-circuit board connector - SPC 5/ 2-STCL-7,62 - 1718481

Approvals

cULus Recognized		http://database.ul.com/cgi-bin/XYV/template/LISEXT/1FRAME/index.htm	E60425-19920722
	B	C	
Nominal voltage UN	600 V	600 V	
Nominal current IN	35 A	35 A	
mm ² /AWG/kcmil	24-8	24-8	

Accessories

Accessories

Cable end sleeve

Ferrule - AI 4 -15 GY - 1200264



Ferrule, sleeve length: 15 mm, length: 23 mm, color: gray

Coding element

Coding profile - CP-PC RD - 1701967



Coding profile, for plugging into the coding ribs of the plug at a later date, insulating material, color: Red

Crimping tool

Crimping pliers - CRIMPFOX 6 - 1212034



Crimping pliers, for ferrules without insulating collar according to DIN 46228 Part 1 and ferrules with insulating collar according to DIN 46228 Part 4, 0.25 mm² ... 6.0 mm², lateral entry, trapezoidal crimp

Labeled terminal marker

Printed-circuit board connector - SPC 5/ 2-STCL-7,62 - 1718481

Accessories

Marker card - SK 7,62/3,8:FORTL.ZAHLEN - 0804549



Marker card, Card, white, labeled, horizontal: consecutive numbers 1 ... 10, 11 ... 20, etc. up to 91 ... 100, mounting type: adhesive, for terminal block width: 7.62 mm, lettering field size: 7.62 x 3.8 mm

Marker card - SK 3,8 REEL P7,62 WH CUS - 0825128



Marker card, Card, can be ordered: by card, white, labeled according to customer specifications, mounting type: adhesive, for terminal block width: 7.62 mm, lettering field size: continuous x 3.8 mm

Screwdriver tools

Screwdriver - SZF 1-0,6X3,5 - 1204517



Actuation tool, for ST terminal blocks, also suitable for use as a bladed screwdriver, size: 0.6 x 3.5 x 100 mm, 2-component grip, with non-slip grip

Terminal marking

Marker card - SK U/3,8 WH:UNBEDRUCKT - 0803906



Marker card, Sheet, white, unlabeled, can be labeled with: PLOTMARK, CMS-P1-PLOTTER, Office printing systems, mounting type: adhesive, for terminal block width: 210 mm, lettering field size: 186 x 3.8 mm, Number of individual labels: 1440

Marker strip - SK 3,8 WH:REEL - 0805218



Marker strip, Roll, white, unlabeled, can be labeled with: THERMOMARK ROLL 2.0, THERMOMARK ROLL, THERMOMARK ROLL X1, THERMOMARK ROLLMASTER 300/600, THERMOMARK X1.2, mounting type: adhesive, for terminal block width: 90000 mm, lettering field size: continuous x 3.8 mm, Number of individual labels: 210000

Additional products

Printed-circuit board connector - SPC 5/ 2-STCL-7,62 - 1718481

Accessories

Printed-circuit board connector - ISPC 5/ 2-STGCL-7,62 - 1748862



PCB connector, nominal cross section: 6 mm², color: green, nominal current: 41 A, rated voltage (III/2): 1000 V, contact surface: Tin, type of contact: Male connector, Number of potentials: 2, Number of rows: 1, Number of positions per row: 2, number of connections: 2, product range: ISPC 5/..-STGCL, pitch: 7.62 mm, connection method: Push-in spring connection, conductor/PCB connection direction: 0 °, Locking clip: - without locking clip, plug-in system: POWER COMBICON 5, Locking: Clip locking, type of packaging: packed in cardboard

Phoenix Contact 2021 © - all rights reserved
<http://www.phoenixcontact.com>

PHOENIX CONTACT GmbH & Co. KG
Flachsmarktstr. 8
32825 Blomberg
Germany
Tel. +49 5235 300
Fax +49 5235 3 41200
<http://www.phoenixcontact.com>