



**MQS**

TE Internal #: 1719545-5

Automotive Terminals, Receptacle, Mating Tab Width .63 mm [.025 in], Tab Thickness .025 in [.63 mm], 22 – 20 AWG Wire Size, MQS

[View on TE.com >](#)

Terminals & Splices > Automotive Terminals > MQS, RECEPTACLE AND TAB

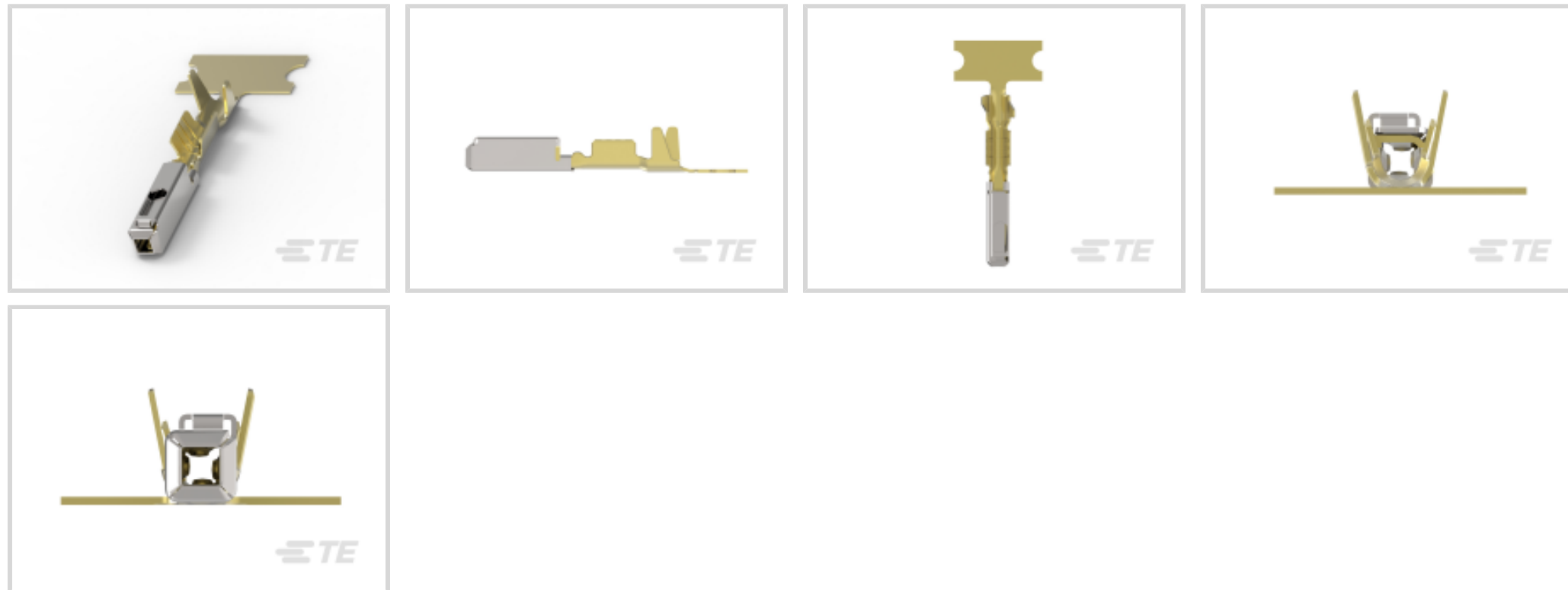

Terminal Type: **Receptacle**

Mating Tab Width: **.63 mm [.025 in]**

Mating Tab Thickness: **.63 mm [.025 in]**

Terminal Transmits: **0 – 24 A (Low Power)**

Wire Size: **22 – 20 AWG**

[All MQS, RECEPTACLE AND TAB \(125\)](#)

**Features**

**Product Type Features**

Receptacle Style	180°
Sealable	No
Primary Locking Feature	Clean Body

**Contact Features**

Contact Size	.63mm
Contact Fabrication	Stamped & Formed
Typical Current Rating	5 A
Crimp Type	F-Crimp
Terminal Type	Receptacle
Mating Tab Width	.63 mm[.025 in]
Mating Tab Thickness	.63 mm[.025 in]
Interface Plating	Gold (Au)
Contact Termination Area Plating Material	Gold (Au)



### Termination Features

Termination Method to Wire & Cable	Crimp
Product Terminates To	Wire

### Dimensions

Wire Size	.32 – .52 mm <sup>2</sup>
Wire Size Search	20 AWG, 21 AWG, 22 AWG
Wire Insulation Diameter	1.5 – 1.85 mm [.059 – .074 in]

### Usage Conditions

Insulation Option	Uninsulated
Operating Temperature (Max)	80 °C, 85 °C, 90 °C, 100 °C, 105 °C, 110 °C, 120 °C, 125 °C, 130 °C, 140 °C [176 °F][185 °F][194 °F][212 °F][221 °F][230 °F][248 °F][257 °F][266 °F][284 °F]
Operating Temperature Range	-40 – 140 °C [-40 – 284 °F]

### Operation/Application

Compatible With Wire Base Material	Copper
------------------------------------	--------

### Packaging Features

Packaging Method	Reel
Packaging Quantity	10000

### Other

Terminal Transmits	0 – 24 A (Low Power)
--------------------	----------------------

### Product Compliance

[For compliance documentation, visit the product page on TE.com>](#)

EU RoHS Directive 2011/65/EU	Compliant
EU ELV Directive 2000/53/EC	Compliant
China RoHS 2 Directive MIIT Order No 32, 2016	No Restricted Materials Above Threshold
EU REACH Regulation (EC) No. 1907/2006	Current ECHA Candidate List: JUNE 2022 (224) Candidate List Declared Against: JAN 2022 (223) SVHC > Threshold: Not Yet Reviewed
Halogen Content	Low Halogen - Br, Cl, F, I < 900 ppm per homogenous material. Also BFR/CFR/PVC Free



Solder Process Capability

Not applicable for solder process capability

Product Compliance Disclaimer

This information is provided based on reasonable inquiry of our suppliers and represents our current actual knowledge based on the information they provided. This information is subject to change. The part numbers that TE has identified as EU RoHS compliant have a maximum concentration of 0.1% by weight in homogenous materials for lead, hexavalent chromium, mercury, PBB, PBDE, DBP, BBP, DEHP, DIBP, and 0.01% for cadmium, or qualify for an exemption to these limits as defined in the Annexes of Directive 2011/65/EU (RoHS2). Finished electrical and electronic equipment products will be CE marked as required by Directive 2011/65/EU. Components may not be CE marked. Additionally, the part numbers that TE has identified as EU ELV compliant have a maximum concentration of 0.1% by weight in homogenous materials for lead, hexavalent chromium, and mercury, and 0.01% for cadmium, or qualify for an exemption to these limits as defined in the Annexes of Directive 2000/53/EC (ELV). Regarding the REACH Regulation, the information TE provides on SVHC in articles for this part number is based on the latest European Chemicals Agency (ECHA) 'Guidance on requirements for substances in articles' posted at this URL: <https://echa.europa.eu/guidance-documents/guidance-on-reach>

### Compatible Parts



TE Part # 2305570-1  
TERMINAL CUTTER, SIDE FEED



TE Part # 2-2151776-1  
OC-PA-S-FM-055F0800-001-0235



TE Part # 2-2151776-2  
OC-PA-S-FA-055F0800-001-0235



TE Part # 2151776-1  
OC-AT-S-FM-055F0800-001-0235



TE Part # 2151776-2  
OC-AT-S-FA-055F0800-001-0235



**KIT**  
TE Part # 7-2151776-7  
OC-055F0800-CRIMPTOOLINGKIT

### Also in the Series | MQS



Automotive Connector Caps & Covers (132)



Automotive Connector EMC Shielding (2)



Automotive Connector Locks & Position Assurance(29)



Automotive Housings(489)



Automotive Seals &amp; Cavity Plugs(26)

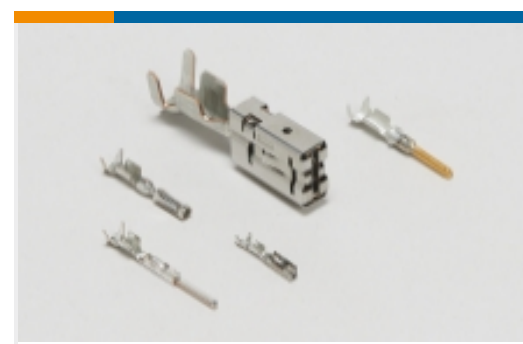

Automotive Terminals(96)



Insertion &amp; Extraction Tools(42)

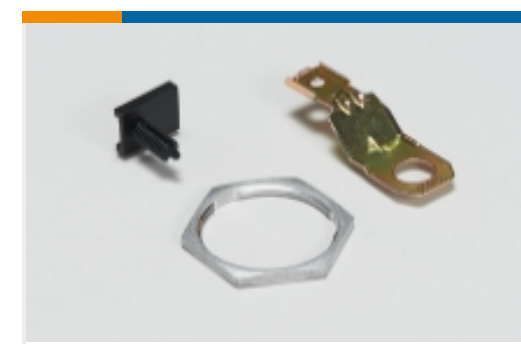

Other Automotive Connector Accessories(13)



PCB Headers &amp; Receptacles(207)

## Customers Also Bought

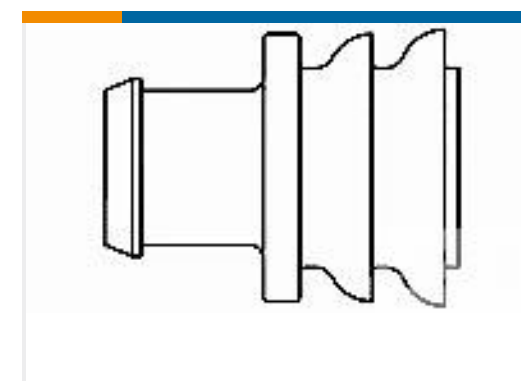
TE Part #DT04-2P  
DEUTSCH DT Series Housings & ConnectorsTE Part #W2S  
DEUTSCH DT WEDGELOCKSTE Part #282104-1  
AMP SUPERSEAL 1.5MM,  
CONNECTOR HOUSINGTE Part #281934-2  
SINGLE WIRE SEALTE Part #0460-202-16141  
DEUTSCH SOLID CONTACTSTE Part #114017-ZZ  
SEALING PLUG, SIZE 12/16, WHT

## Documents

### Product Drawings

[MQS0,63 Au rec CB unseal. AWG22-20](#)

English

[MQS0,63 Au rec CB unseal. AWG22-20](#)

English

### CAD Files

[3D PDF](#)



3D

Customer View Model

[ENG\\_CVM\\_CVM\\_1719545-5\\_C.2d\\_dxf.zip](#)

English

Customer View Model

[ENG\\_CVM\\_CVM\\_1719545-5\\_C.3d\\_igs.zip](#)

English

Customer View Model

[ENG\\_CVM\\_CVM\\_1719545-5\\_C.3d\\_stp.zip](#)

English

By downloading the CAD file I accept and agree to the [Terms and Conditions](#) of use.

### Datasheets & Catalog Pages

[Micro Quadlok Interconnection System \(MQS\)](#)

English

### Product Specifications

[Application Specification](#)

English

[Application Specification](#)

German

[Application Specification](#)

English