

172520-8 ✓ ACTIVE

AMP-IN

TE Internal #: 172520-8

Housing, Plug, Wire-to-Board, 8 Position, 2.5 mm [.098 in]
Centerline, Crimp, 1 Row, Natural, Printed Circuit Board, Power & Signal

[View on TE.com >](#)



Connectors > PCB Connectors > Wire-to-Board Connectors > Wire-to-Board Connector Assemblies & Housings

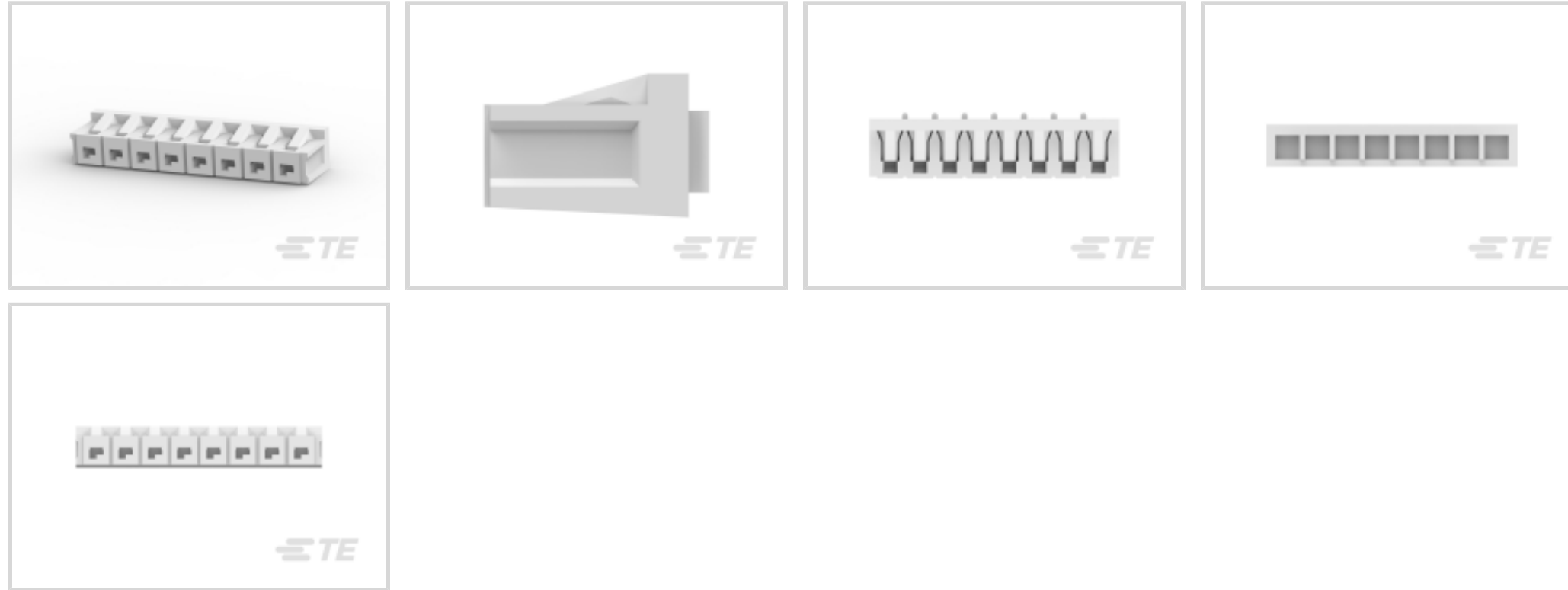

Connector Product Type: **Housing**

Connector & Housing Type: **Plug**

Connector System: **Wire-to-Board**

Number of Positions: **8**

Centerline (Pitch): **2.5 mm [.098 in]**

Features

Product Type Features

Connector Product Type	Housing
Connector & Housing Type	Plug
Connector System	Wire-to-Board
Sealable	No
Connector & Contact Terminates To	Printed Circuit Board

Configuration Features

Number of Positions	8
Number of Rows	1

Electrical Characteristics

Operating Voltage	250 VAC
-------------------	---------

Contact Features

Contact Layout	Inline
Contact Type	Pin
Contact Base Material	Brass



Termination Features

Termination Method to Wire & Cable	Crimp
------------------------------------	-------

Mechanical Attachment

Strain Relief	Without
Panel Mount Feature	Without
PCB Mount Retention	Without
Mating Retention	Without
Connector Mounting Type	Cable Mount (Free-Hanging)

Housing Features

Housing Entry Configuration	Both Ends Closed
Housing Material	Nylon 6/6
Centerline (Pitch)	2.5 mm [.098 in]
Housing Color	Natural

Dimensions

Connector Length	21 mm [.826 in] .14 in
PCB Thickness (Recommended)	1.19 – 1.6 mm, 1.57 mm
Wire Size	.05 – .15 mm ² , .12 – .35 mm ²

Usage Conditions

Operating Temperature Range	-40 – 105 °C [-40 – 221 °F]
-----------------------------	-----------------------------

Operation/Application

Circuit Application	Power & Signal
---------------------	----------------

Industry Standards

UL Flammability Rating	UL 94V-0
------------------------	----------

Packaging Features

Packaging Quantity	2000
Packaging Method	Bag

Product Compliance

For compliance documentation, visit the product page on [TE.com](https://www.te.com)>

EU RoHS Directive 2011/65/EU	Compliant
------------------------------	-----------







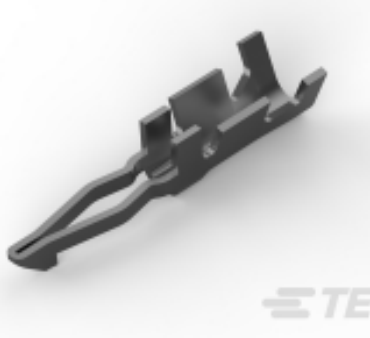

EU ELV Directive 2000/53/EC	Compliant
China RoHS 2 Directive MIIT Order No 32, 2016	No Restricted Materials Above Threshold
EU REACH Regulation (EC) No. 1907/2006	Current ECHA Candidate List: JUNE 2022 (224) Candidate List Declared Against: JAN 2022 (223) SVHC > Threshold: Not Yet Reviewed
Halogen Content	Low Halogen - Br, Cl, F, I < 900 ppm per homogenous material. Also BFR/CFR/PVC Free
Solder Process Capability	Not applicable for solder process capability

Product Compliance Disclaimer

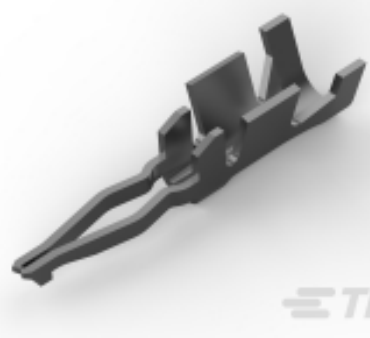
This information is provided based on reasonable inquiry of our suppliers and represents our current actual knowledge based on the information they provided. This information is subject to change. The part numbers that TE has identified as EU RoHS compliant have a maximum concentration of 0.1% by weight in homogenous materials for lead, hexavalent chromium, mercury, PBB, PBDE, DBP, BBP, DEHP, DIBP, and 0.01% for cadmium, or qualify for an exemption to these limits as defined in the Annexes of Directive 2011/65/EU (RoHS2). Finished electrical and electronic equipment products will be CE marked as required by Directive 2011/65/EU. Components may not be CE marked. Additionally, the part numbers that TE has identified as EU ELV compliant have a maximum concentration of 0.1% by weight in homogenous materials for lead, hexavalent chromium, and mercury, and 0.01% for cadmium, or qualify for an exemption to these limits as defined in the Annexes of Directive 2000/53/EC (ELV). Regarding the REACH Regulation, the information TE provides on SVHC in articles for this part number is based on the latest European Chemicals Agency (ECHA) 'Guidance on requirements for substances in articles' posted at this URL: <https://echa.europa.eu/guidance-documents/guidance-on-reach>

Compatible Parts

 <p>TE Part # 172782-5 LOW PROFILE MINI AMP-IN</p>	 <p>TE Part # 172781-4 LOW PROFILE MINI AMP-IN (AWG#30-#26)Y-TY</p>	 <p>TE Part # 172781-3 LOW PROFILE MINI AMP-IN (AWG#30-#26)X-TY</p>	 <p>TE Part # 172782-7 LOW PROFILE MINI AMP-IN</p>
 <p>TE Part # 172781-1 MINI AMP-IN TERM 30-26 PTPBR</p>	 <p>TE Part # 172781-2 MINI AMP IN</p>	 <p>TE Part # 8-172782-6 LOW PROFILE MINI AMP-IN</p>	

Customers Also Bought

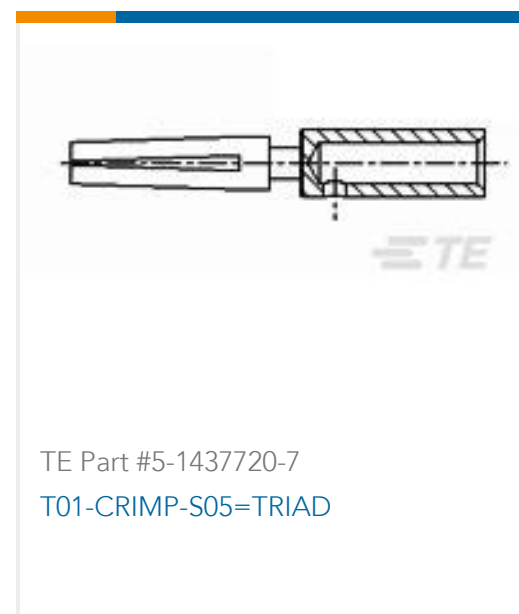

Documents

Product Drawings

8P 2.5MM MINI AMP-IN HDR HSG

English

CAD Files

3D PDF

English

Customer View Model

[ENG_CVM_172520-8_G1.3d_stp.zip](#)

English

Customer View Model

[ENG_CVM_172520-8_G1.2d_dxf.zip](#)

English

Customer View Model

[ENG_CVM_172520-8_G1.3d_igs.zip](#)

English

3D PDF

3D

Customer View Model

[ENG_CVM_CVM_172520-8_E.2d_dxf.zip](#)

English

Customer View Model

[ENG_CVM_CVM_172520-8_E.3d_igs.zip](#)

English

Customer View Model

[ENG_CVM_CVM_172520-8_E.3d_stp.zip](#)

English



By downloading the CAD file I accept and agree to the [Terms and Conditions](#) of use.

Datasheets & Catalog Pages

PRINTED CIRCUIT BOARD TERMINALS AND DISCONNECTS

English

Product Specifications

Product Specification

English

Product Environmental Compliance

MD_172520-8_062820182129_dmtec

English

MD_172520-8_062820182129_dmtec

English

Agency Approvals

UL Report

English