

175019-1 ✓ ACTIVE

[Positive Lock](#) | [Positive Lock 187](#)

TE Internal #: 175019-1

Quick Disconnects, Receptacle, 22 – 16 AWG Wire Size, .32 – 1.31 mm² Wire Size, Mating Tab Width .187 in [4.75 mm], Flag, Brass, Positive Lock 187

[View on TE.com >](#)



Terminals & Splices > Quick Disconnects

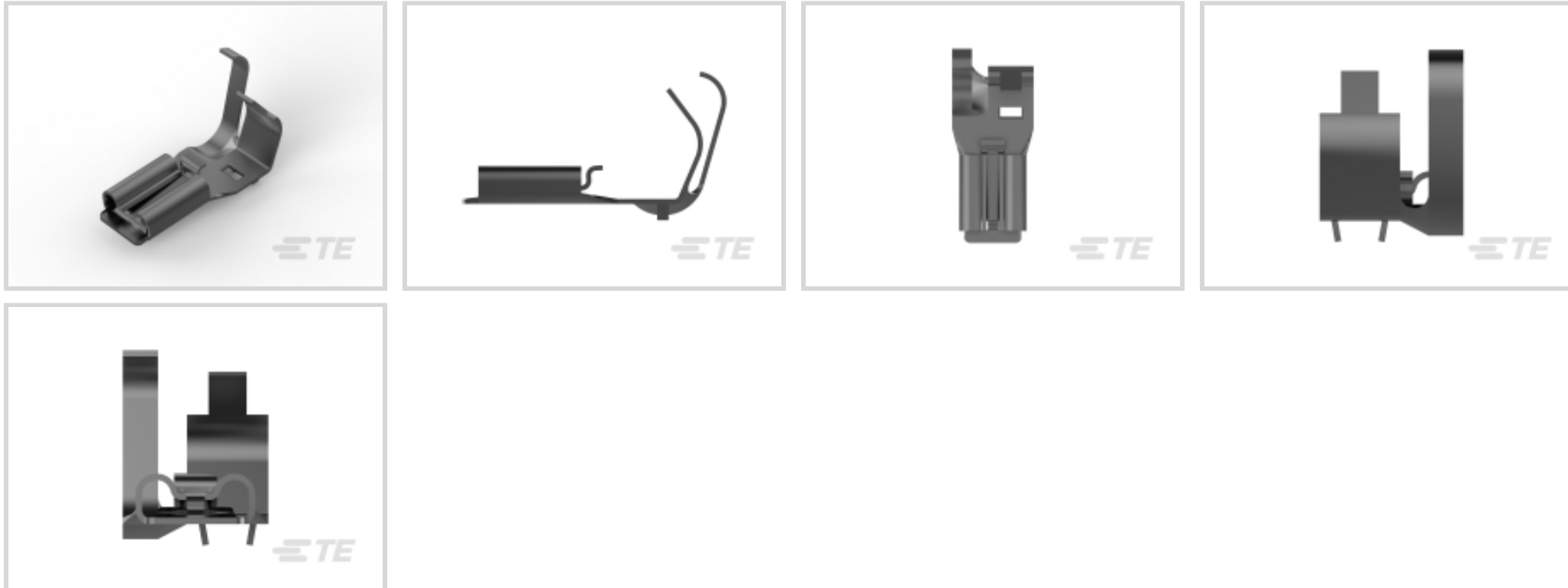

Quick Disconnect Terminal Type: **Receptacle**

Wire Size: .32 – 1.31 mm²

Mating Tab Width: 4.75 mm [.187 in]

Mating Tab Thickness: .51 mm [.02 in]

Features

Product Type Features

Terminates To	Wire & Cable
Wire Stop	No
Wire/Cable Type	Regular Wire
Sealable	No

Configuration Features

Connection Capacity	Single
---------------------	--------

Electrical Characteristics

Voltage (Max)	250 V
---------------	-------

Contact Features

Quick Disconnect Terminal Type	Receptacle
Mating Tab Width	4.75 mm [.187 in]
Mating Tab Thickness	.51 mm [.02 in]
Terminal Orientation	Flag
Contact Base Material	Brass



Terminal Plating Material	Pre-Tin
---------------------------	---------

Crimp Type	F-Crimp
------------	---------

Barrel Type	Open
-------------	------

Mechanical Attachment

Wire Insulation Support	With
-------------------------	------

Dimensions

Accepts Wire Insulation Diameter Range	1.7 – 4.32 mm [.066 – .17 in]
--	-------------------------------

Overall Length	15.9 mm [.625 in]
----------------	-------------------

Receptacle Terminal Stock Thickness	.3 mm [.012 in]
-------------------------------------	-----------------

Wire Size	.32 – 1.31 mm ²
-----------	----------------------------

Usage Conditions

Insulation Option	Fully Insulated
-------------------	-----------------

Operating Temperature Range	-40 – 110 °C [-40 – 230 °F]
-----------------------------	-----------------------------

Packaging Features

Packaging Quantity	4000
--------------------	------

Packaging Method	Strip/Reel
------------------	------------

Product Compliance

[For compliance documentation, visit the product page on TE.com>](#)

EU RoHS Directive 2011/65/EU	Compliant
------------------------------	-----------

EU ELV Directive 2000/53/EC	Compliant
-----------------------------	-----------

China RoHS 2 Directive MIIT Order No 32, 2016	No Restricted Materials Above Threshold
---	---

EU REACH Regulation (EC) No. 1907/2006	Current ECHA Candidate List: JUNE 2022 (224) Candidate List Declared Against: JAN 2022 (223) SVHC > Threshold: Not Yet Reviewed
--	--

Halogen Content	Low Halogen - Br, Cl, F, I < 900 ppm per homogenous material. Also BFR/CFR/PVC Free
-----------------	---

Solder Process Capability	Not applicable for solder process capability
---------------------------	--

Product Compliance Disclaimer

This information is provided based on reasonable inquiry of our suppliers and represents our current actual knowledge based on the information they provided. This information is subject to change. The part numbers that TE has identified as EU RoHS compliant have a maximum concentration of 0.1% by weight in homogenous materials for lead, hexavalent

chromium, mercury, PBB, PBDE, DBP, BBP, DEHP, DIBP, and 0.01% for cadmium, or qualify for an exemption to these limits as defined in the Annexes of Directive 2011/65/EU (RoHS2). Finished electrical and electronic equipment products will be CE marked as required by Directive 2011/65/EU. Components may not be CE marked. Additionally, the part numbers that TE has identified as EU ELV compliant have a maximum concentration of 0.1% by weight in homogenous materials for lead, hexavalent chromium, and mercury, and 0.01% for cadmium, or qualify for an exemption to these limits as defined in the Annexes of Directive 2000/53/EC (ELV). Regarding the REACH Regulation, the information TE provides on SVHC in articles for this part number is based on the latest European Chemicals Agency (ECHA) 'Guidance on requirements for substances in articles' posted at this URL: <https://echa.europa.eu/guidance-documents/guidance-on-reach>

Compatible Parts



TE Part # 2232342-1
187 PL EX FLAG REC. 22-16AWG PTBR



TE Part # 1-178708-4
PL EX SLEEVE 187 FLAG YELLOW 6/6 NYLON



TE Part # 1-178708-1
187 SLEEVE PL EX FLAG NAT



TE Part # 1-178708-7
PL EX SLEEVE 187 FLAG RED 6/6 NYLON



TE Part # 1-178708-5
SLEEVE FOR 187 POSITIVE LOCK



TE Part # 1-178708-6
PL EX SLEEVE 187 FLAG BLUE 6/6 NYLON



TE Part # 1-178708-9
PL EX SLEEVE 187 FLAG BLACK 6/6 NYLON



TE Part # 1743058-1
PL 187 REC 22-16 AWG 0.3 X 22.8 PTBR



TE Part # 1743221-1
250 PL EX FLAG REC. 18-12AWG PTBR



TE Part # 1743643-1
Pos Lock 250 Rec Flag Hsg 2P Nat



TE Part # 1743643-6
Pos Lock 250 Rec Flag Hsg 2P Blu



TE Part # 1743643-9
Pos Lock 250 Rec Flag Hsg 2P Blk



TE Part # 368601-1
POSITIVE LOCK EX 187 HOUSING REC



TE Part # 567405-1
M HB EMPO140T1400 T 175019



TE Part # 567405-2
HDM HB 9EMPR140T1400 K



TE Part # 567405-3
HDM*HB* 9EMPR140T1400 G



TE Part # 567405-4
HDMHB 9EAPR140T1400 G

Also in the Series | Positive Lock 187

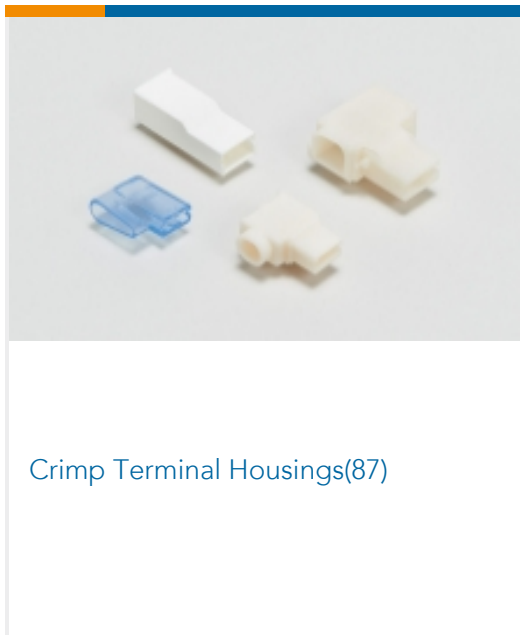

Crimp Terminal Housings(87)

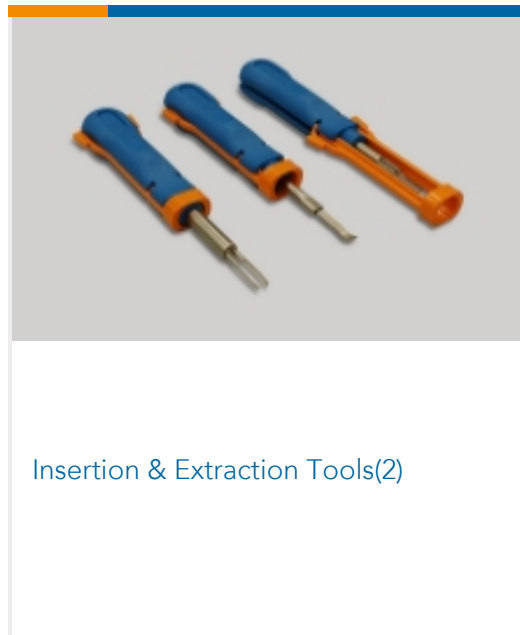

Insertion & Extraction Tools(2)



Insulation Boots & Sleeves(7)

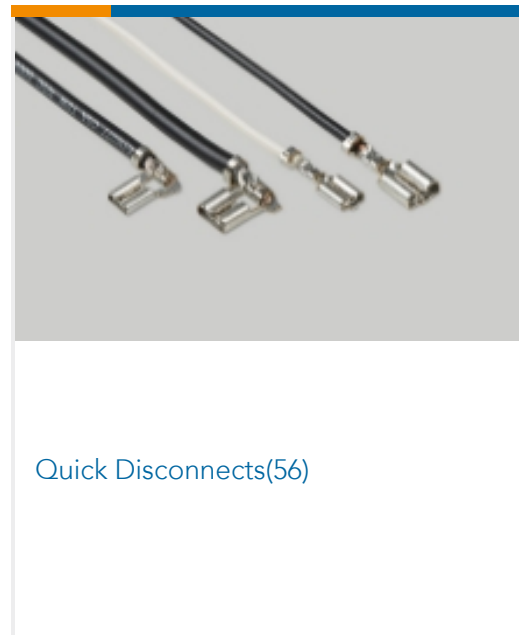

Quick Disconnects(56)

Customers Also Bought

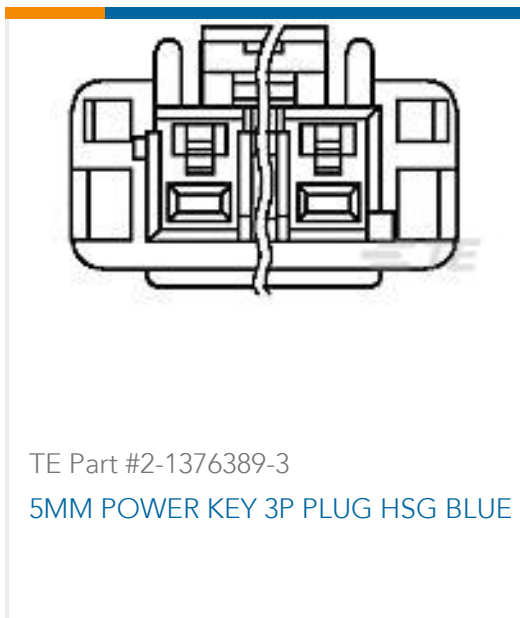

TE Part #2-1376389-3
5MM POWER KEY 3P PLUG HSG BLUE



TE Part #1746973-1
GRACE INERTIA CONNECTOR 6.2
MM PITCH TAB



TE Part #176448-1
187 HSG. PL MKII TAB NAT

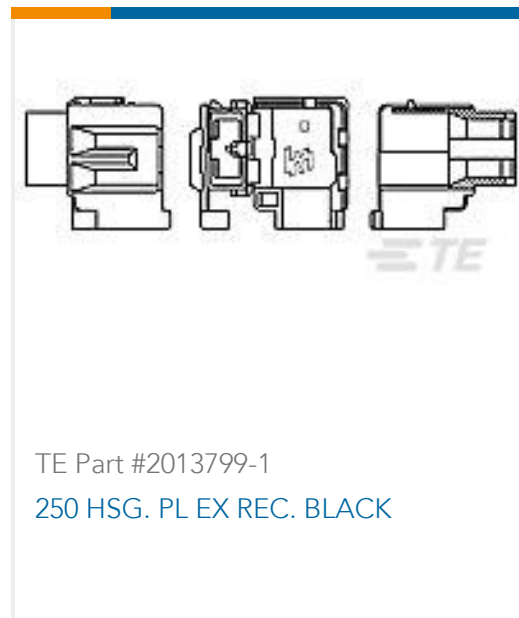

TE Part #2013799-1
250 HSG. PL EX REC. BLACK



TE Part #175022-1
250 PL EX REC. 18-14AWG PTBR

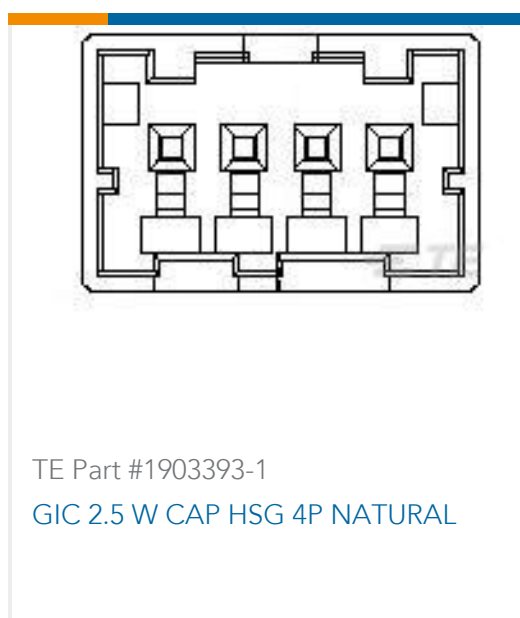

TE Part #1903393-1
GIC 2.5 W CAP HSG 4P NATURAL



TE Part #170046-2
250 FASTON,REC.,16-14 AWG,TPBR



TE Part #1-172128-1
FF 250 PLUG HSG 1P NYLON NAT

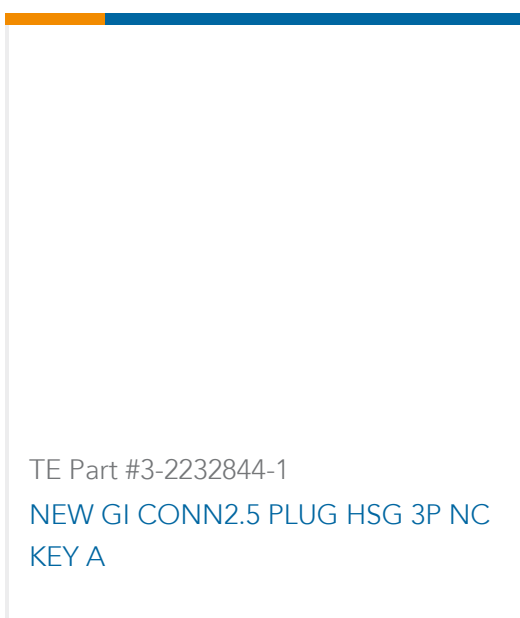

TE Part #3-2232844-1
NEW GI CONN2.5 PLUG HSG 3P NC
KEY A



Documents

Product Drawings

[187 PL EX FLAG REC. 22-16AWG PTBR](#)

English

CAD Files

[3D PDF](#)

3D

Customer View Model

[ENG_CVM_CVM_175019-1_L_c-175019-1-l.2d_dxf.zip](#)

English

Customer View Model

[ENG_CVM_CVM_175019-1_L_c-175019-1-l.3d_igs.zip](#)

English

Customer View Model

[ENG_CVM_CVM_175019-1_L_c-175019-1-l.3d_stp.zip](#)

English

By downloading the CAD file I accept and agree to the [Terms and Conditions](#) of use.

Product Specifications

[Application Specification](#)

Japanese

[Crimping "187" Series Flag Type Positive Lock EX Contact](#)

Japanese

Product Environmental Compliance

[MD_175019-1_053120182140_dmtec](#)

English

[MD_175019-1_053120182140_dmtec](#)

English

Instruction Sheets

[Instruction Sheet \(non U.S.\)](#)

English

[POSITIVE LOCK EX CONTACT](#)

English

Agency Approvals

[Agency Approval Document](#)

English