

1744037-4 ✓ ACTIVE



Economy Power

TE Internal #: 1744037-4

Rectangular Power Connectors, Header, Plug, Wire-to-Board, 4 Position, .2 in [5.08 mm] Centerline, Printed Circuit Board, UL 94V-0, Economy Power

[View on TE.com >](#)

Connectors > Power Connectors > Rectangular Power > Rectangular Power Connectors



Rectangular Power Connector Type: **Header**

Connector & Housing Type: **Plug**

Connector System: **Wire-to-Board**

Number of Positions: **4**

Centerline (Pitch): **5.08 mm [.2 in]**

Features

Product Type Features

Header Type	Partially Shrouded
Rectangular Power Connector Type	Header
Connector & Housing Type	Plug
Connector System	Wire-to-Board
Sealable	No
Connector & Contact Terminates To	Printed Circuit Board

Configuration Features

Number of Positions	4
PCB Mount Orientation	Vertical
Number of Power Positions	4
Number of Rows	1

Electrical Characteristics

Operating Voltage	250 VDC
-------------------	---------

Contact Features



Contact Layout	Inline
Contact Base Material	Copper Alloy
Contact Current Rating (Max)	8 A
Contact Retention Within Housing	Without
Contact Type	Pin
PCB Contact Termination Area Plating Material	Tin
Contact Mating Area Plating Material	Tin
Contact Mating Area Plating Material Thickness	2.03 μm [80 μin]
Contact Termination Area Plating Thickness	.8 μm , 1 μm [31.49 μin][39.37 μin]

Termination Features

Termination Post & Tail Length	3.7 mm[.146 in]
Termination Method to Printed Circuit Board	Through Hole - Solder

Mechanical Attachment

Strain Relief	Without
Mating Alignment	With
PCB Mount Alignment	Without
Panel Mount Feature	Without
PCB Mount Retention	Without
Connector Mounting Type	Board Mount
Mating Retention	With
Mating Retention Type	Latch

Housing Features

Centerline (Pitch)	5.08 mm[.2 in]
Housing Color	Natural
Housing Material	Nylon 66

Dimensions

PCB Thickness (Recommended)	.06 mm[1.6 in]
Width	8.2 mm[.323 in]
Height	10.9 mm[.429 in]
Length	17.84 mm[.702 in]

Usage Conditions

Operating Temperature Range	-25 – 105 $^{\circ}\text{C}$ [-13 – 221 $^{\circ}\text{F}$]
-----------------------------	--



Operation/Application

Circuit Application	Power
---------------------	-------

Industry Standards

UL Flammability Rating	UL 94V-0
Glow Wire Rating	Standard Part - Not Glow Wire

Packaging Features

Packaging Method	Bag
Packaging Quantity	1000

Other

For Use With	Receptacle Assembly
--------------	---------------------

Product Compliance

[For compliance documentation, visit the product page on TE.com>](#)

EU RoHS Directive 2011/65/EU	Compliant
EU ELV Directive 2000/53/EC	Compliant
China RoHS 2 Directive MIIT Order No 32, 2016	No Restricted Materials Above Threshold
EU REACH Regulation (EC) No. 1907/2006	Current ECHA Candidate List: JUNE 2022 (224) Candidate List Declared Against: JAN 2022 (223) SVHC > Threshold: Not Yet Reviewed
Halogen Content	Low Halogen - Br, Cl, F, I < 900 ppm per homogenous material. Also BFR/CFR/PVC Free
Solder Process Capability	Wave solder capable to 240°C

Product Compliance Disclaimer

This information is provided based on reasonable inquiry of our suppliers and represents our current actual knowledge based on the information they provided. This information is subject to change. The part numbers that TE has identified as EU RoHS compliant have a maximum concentration of 0.1% by weight in homogenous materials for lead, hexavalent chromium, mercury, PBB, PBDE, DBP, BBP, DEHP, DIBP, and 0.01% for cadmium, or qualify for an exemption to these limits as defined in the Annexes of Directive 2011/65/EU (RoHS2). Finished electrical and electronic equipment products will be CE marked as required by Directive 2011/65/EU. Components may not be CE marked. Additionally, the part numbers that TE has identified as EU ELV compliant have a maximum concentration of 0.1% by weight in homogenous materials for lead, hexavalent chromium, and mercury, and 0.01% for cadmium, or qualify for an exemption to these limits as defined in the Annexes of Directive 2000/53/EC (ELV). Regarding the REACH Regulation, the information TE provides on SVHC in articles for this part number is based on the latest European Chemicals Agency (ECHA) 'Guidance on requirements for substances in articles' posted at this URL: <https://echa.europa.eu/guidance-documents/guidance-on-reach>

Compatible Parts



TE Part # 1744494-4
04P EP-II HOUSING, YELLOW



TE Part # 1744416-4
4 POS EP II HSG, GLOW WIRE



TE Part # 1744036-4
04P ECONOMY POWER .200 CL HSG



TE Part # 1-2316953-4
04P EP.200 CL HDR ASSY VRT, NO PIN 1,3



TE Part # 2316953-3
03P EP.200 CL HDR ASSY VRT, NO PIN 2



TE Part # 2316953-4
04P EP.200 CL HDR ASSY VRT, NO PIN 2,3

Also in the Series | Economy Power



Connector Contacts(1)



Insertion & Extraction Tools(1)



PCB Headers & Receptacles(166)



PCB Latches, Locks & Retainers(2)



Power Contacts(8)



Rectangular Connector Housings(1)



Rectangular Power Connectors(301)



Wire-to-Board Connector Assemblies & Housings(141)



Wire-to-Board Connector Contacts(6)

Customers Also Bought

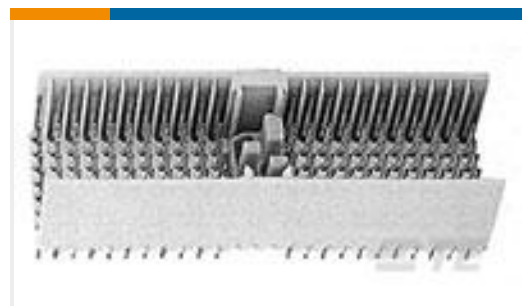

TE Part #5352332-1
2MM HM TYPE A MALE HDR 154 POS

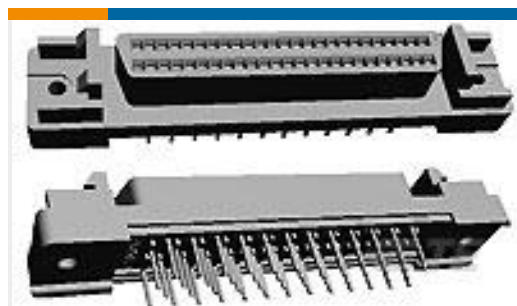

TE Part #5749069-9
100 50SR VERT RCPT ASSYY



TE Part #1744037-2
02P EC PWR.200 CL HDR ASSY VRT



TE Part #1123721-2
ECONOMY POWER CONN REC CONT



TE Part #3-644695-2
02P MTA100 STR HDR RETENTIVE



TE Part #1939115-1
SD CONN STD EMBOSS W/B REVERSE



TE Part #2-2013298-1
EMB OSS TAPE DDR3 204P 8H RVS



TE Part #4-2176374-5
RQ 0805 309R 0.1% 10PPM 1K RL

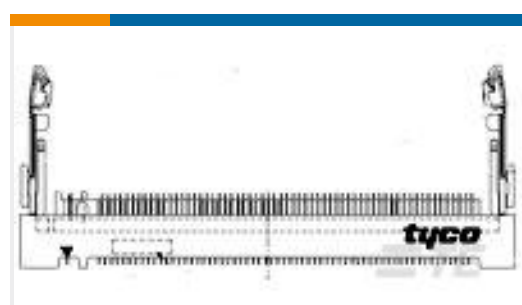

TE Part #1717831-1
MINI PCI EXPRESS SEMI HARD TRAY CONN

Documents

Product Drawings

[04P EC PWR.200 CL HDR ASSY VRT](#)

English

CAD Files

[3D PDF](#)

3D

Customer View Model

[ENG_CVM_CVM_1744037-4_O.2d_dxf.zip](#)

English

Customer View Model

[ENG_CVM_CVM_1744037-4_O.3d_igs.zip](#)

English

Customer View Model

[ENG_CVM_CVM_1744037-4_O.3d_stp.zip](#)

English

By downloading the CAD file I accept and agree to the [Terms and Conditions](#) of use.



Datasheets & Catalog Pages

[1-1773885-9 Economy Power Connectors](#)

English

Product Specifications

[Application Specification](#)

English

[Application Specification](#)

Japanese

Product Environmental Compliance

[TE Material Declaration](#)

English