

172890-7 ✓ ACTIVE



## AMP-IN

TE Internal #: 172890-7

Housing, Plug, Wire-to-Board, 7 Position, 2 mm [.079 in] Centerline,  
Crimp, 1 Row, Natural, Printed Circuit Board, Power & Signal

[View on TE.com >](#)

Connectors > PCB Connectors > Wire-to-Board Connectors > Wire-to-Board Connector Assemblies & Housings

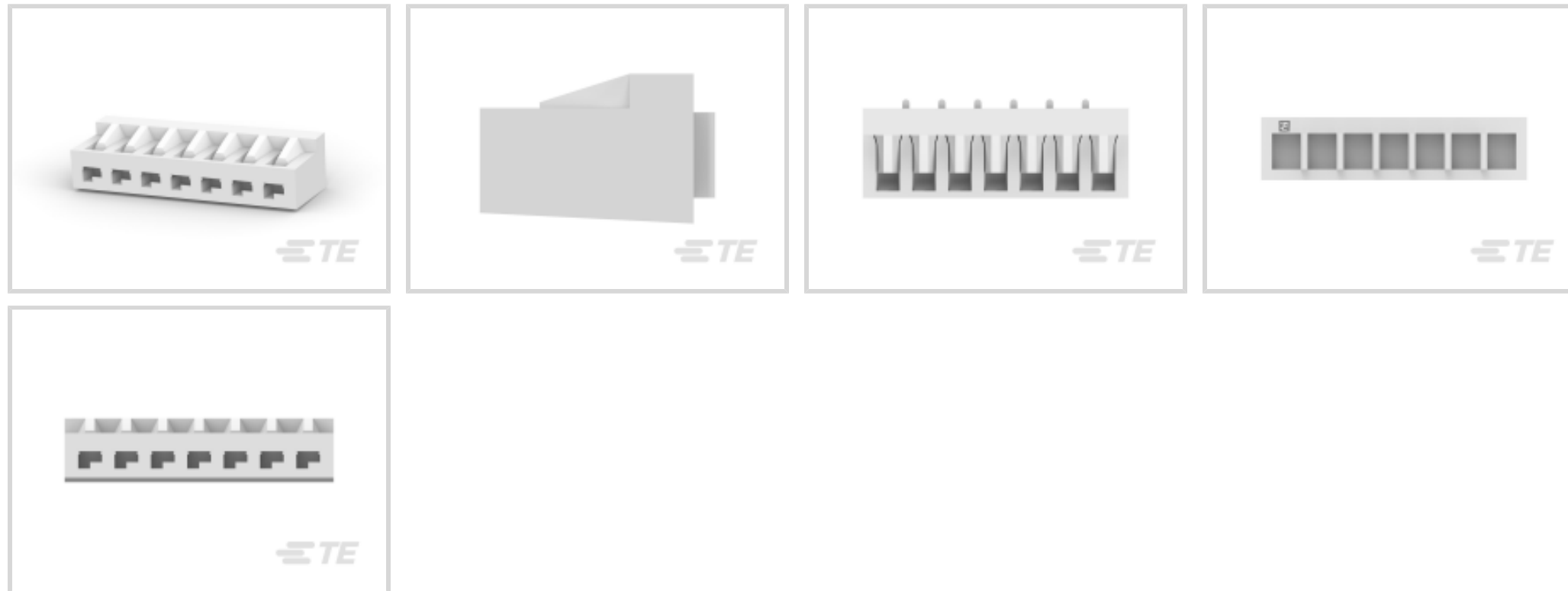

Connector Product Type: **Housing**

Connector & Housing Type: **Plug**

Connector System: **Wire-to-Board**

Number of Positions: **7**

Centerline (Pitch): **2 mm [.079 in]**

## Features

### Product Type Features

Connector Product Type	Housing
Connector & Housing Type	Plug
Connector System	Wire-to-Board
Sealable	No
Connector & Contact Terminates To	Printed Circuit Board

### Configuration Features

Number of Positions	7
Number of Rows	1

### Electrical Characteristics

Operating Voltage	250 VAC
-------------------	---------

### Contact Features

Contact Layout	Inline
Contact Type	Pin
Contact Base Material	Brass



### Termination Features

Termination Method to Wire & Cable	Crimp
------------------------------------	-------

### Mechanical Attachment

Strain Relief	Without
Panel Mount Feature	Without
PCB Mount Retention	Without
Mating Retention	Without
Connector Mounting Type	Cable Mount (Free-Hanging)

### Housing Features

Housing Entry Configuration	Both Ends Closed
Housing Material	Nylon 66
Centerline (Pitch)	2 mm [.079 in]
Housing Color	Natural

### Dimensions

Connector Length	14.8 mm [.58 in] .14 in
PCB Thickness (Recommended)	1.19 – 1.6 mm, 1.57 mm
Wire Size	.05 – .15 mm <sup>2</sup> , .12 – .35 mm <sup>2</sup>

### Usage Conditions

Operating Temperature Range	-40 – 105 °C [-40 – 221 °F]
-----------------------------	-----------------------------

### Operation/Application

Circuit Application	Power & Signal
---------------------	----------------

### Industry Standards

UL Flammability Rating	UL 94V-0
------------------------	----------

### Packaging Features

Packaging Quantity	1000
Packaging Method	Bag

### Product Compliance

For compliance documentation, visit the product page on [TE.com](https://www.te.com)>

EU RoHS Directive 2011/65/EU	Compliant
EU ELV Directive 2000/53/EC	Compliant







China RoHS 2 Directive MIIT Order No 32, 2016	No Restricted Materials Above Threshold
EU REACH Regulation (EC) No. 1907/2006	Current ECHA Candidate List: JUNE 2022 (224) Candidate List Declared Against: JAN 2022 (223) SVHC > Threshold: Not Yet Reviewed
Halogen Content	Low Halogen - Br, Cl, F, I < 900 ppm per homogenous material. Also BFR/CFR/PVC Free
Solder Process Capability	Not applicable for solder process capability

Product Compliance Disclaimer

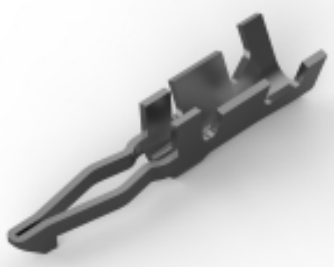
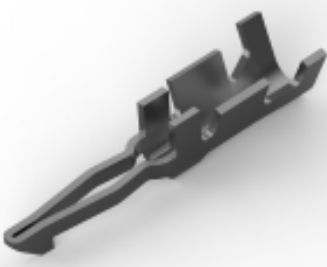
This information is provided based on reasonable inquiry of our suppliers and represents our current actual knowledge based on the information they provided. This information is subject to change. The part numbers that TE has identified as EU RoHS compliant have a maximum concentration of 0.1% by weight in homogenous materials for lead, hexavalent chromium, mercury, PBB, PBDE, DBP, BBP, DEHP, DIBP, and 0.01% for cadmium, or qualify for an exemption to these limits as defined in the Annexes of Directive 2011/65/EU (RoHS2). Finished electrical and electronic equipment products will be CE marked as required by Directive 2011/65/EU. Components may not be CE marked. Additionally, the part numbers that TE has identified as EU ELV compliant have a maximum concentration of 0.1% by weight in homogenous materials for lead, hexavalent chromium, and mercury, and 0.01% for cadmium, or qualify for an exemption to these limits as defined in the Annexes of Directive 2000/53/EC (ELV). Regarding the REACH Regulation, the information TE provides on SVHC in articles for this part number is based on the latest European Chemicals Agency (ECHA) 'Guidance on requirements for substances in articles' posted at this URL: <https://echa.europa.eu/guidance-documents/guidance-on-reach>

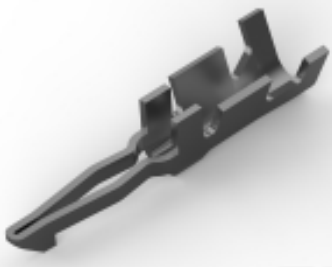
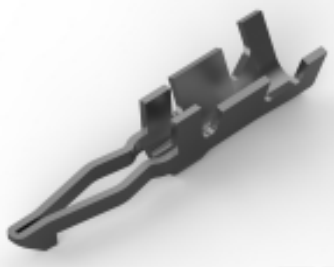
### Compatible Parts

 <p>TE Part # 172782-5 LOW PROFILE MINI AMP-IN</p>	 <p>TE Part # 172781-4 LOW PROFILE MINI AMP-IN (AWG#30-#26)Y-TY</p>	 <p>TE Part # 172781-3 LOW PROFILE MINI AMP-IN (AWG#30-#26)X-TY</p>	 <p>TE Part # 172782-7 LOW PROFILE MINI AMP-IN</p>
 <p>TE Part # 172781-1 MINI AMP-IN TERM 30-26 PTPBR</p>	 <p>TE Part # 172781-2 MINI AMP IN</p>	 <p>TE Part # 8-172782-6 LOW PROFILE MINI AMP-IN</p>	

### Customers Also Bought

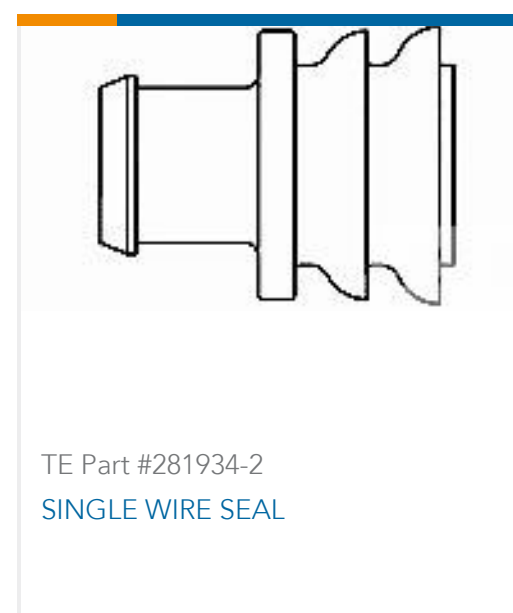
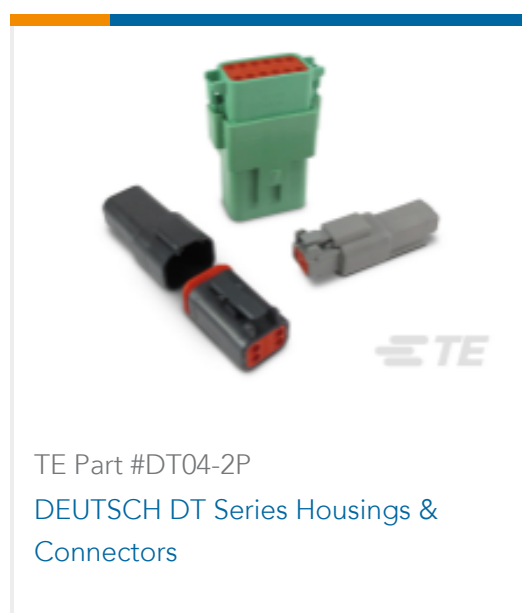

## Documents

### Product Drawings

#### 7P 2MM MINI AMP-IN HDR HSG

English

### CAD Files

#### 3D PDF

3D

#### Customer View Model

[ENG\\_CVM\\_CVM\\_172890-7\\_H.2d\\_dxf.zip](#)

English

#### Customer View Model

[ENG\\_CVM\\_CVM\\_172890-7\\_H.3d\\_igs.zip](#)

English

#### Customer View Model

[ENG\\_CVM\\_CVM\\_172890-7\\_H.3d\\_stp.zip](#)

English

By downloading the CAD file I accept and agree to the [Terms and Conditions](#) of use.

### Datasheets & Catalog Pages

#### PRINTED CIRCUIT BOARD TERMINALS AND DISCONNECTS

English

### Product Specifications

#### Product Specification

English

### Product Environmental Compliance

#### TE Material Declaration



English

---

[Agency Approvals](#)

[UL Report](#)

English