

Features

●Two types circuits

60 circuit and 36 circuit types are available, and the specifications matched to the automobile are selectable.

●Incomplete mating detection mechanism

Mis-insertion and insertion error at the assembly line can detect with a CPA terminal.

●Terminal construction

It is designed to prevent the deformation of the contact area when processing wire harness by protecting the contact area of each terminal with a box.

●Press-fit

There are dip type and press-fit type in the male connector.

The miniaturization is realized as air-bag ECU I/O connector for automobile.

This product has various circuit development and several adoption results proven, hence it enables to select the type to meet the automobile.

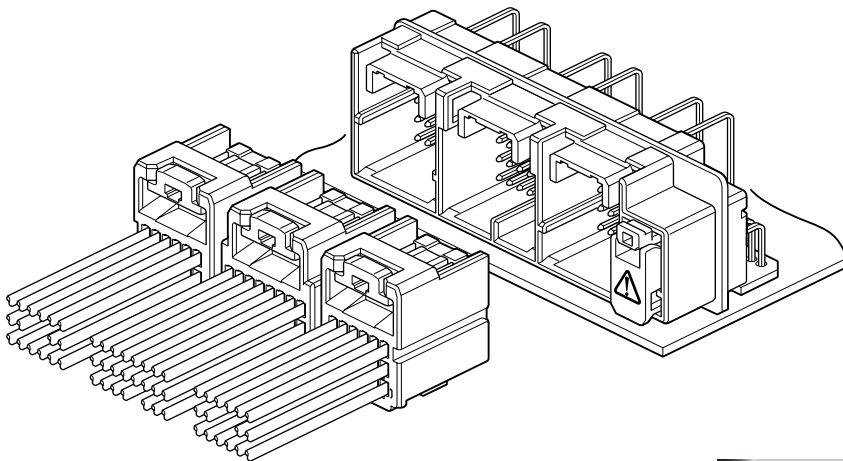

Specifications

- Current rating: 5 A AC, DC (0.5 mm², Single circuit)
- Voltage rating: 50 V AC, DC
- Temperature range: -40°C to +105°C
(including temperature rise in applying electrical current)
- Contact resistance: Initial value/ 8 mΩ max.
After environmental tests/ 16 mΩ max.
- Insulation resistance: 100 MΩ min.
- Withstanding voltage: 100 VDC/minute
- Applicable wire: AVSS/CAVS
0.64 Terminal S; 0.3 mm² to 0.5 mm²
CHFUS
0.64 Terminal SSS/SS; 0.13 mm² to 0.35 mm²

- * Compliant with ELV/RoHS.
- * Contact JST for details.

Female terminal

• 0.64 Female terminal SSS/SS

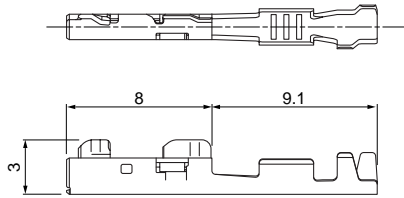

• 0.64 Female terminal S

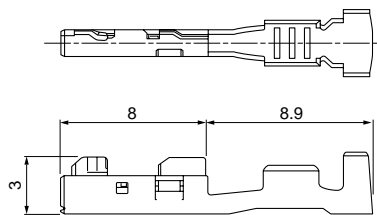

Terminal	Model No.	Applicable wire range		Q'ty/reel
		Conductor (mm ²)	Insulation O.D. (mm)	
*0.64 SSS	① SNAC3-A001T-M0.64	0.13	0.85	6,000
*0.64 SS	① SNAC3-A011T-M0.64	0.22 to 0.35	0.95 to 1.10	5,000
0.64 S	① SNAC3-A021T-M0.64	0.3 to 0.5	1.4 to 1.8	5,000
	② SNAC3-A021GI-M0.64-1			
	③ SNAC3-A021GF-M0.64-1			

Material and Finish

- ① Copper alloy, tin-plated (reflow treatment)
- ② Copper alloy, nickel-undercoated,
Male contact area; tin-plated (reflow treatment)
Short terminal contact area; gold-plated
- ③ Copper alloy, nickel-undercoated,
Male contact area; gold-plated
Short terminal contact area; gold-plated

Note: *Please contact JST about the use of these parts.

Female connector

• 8 circuits

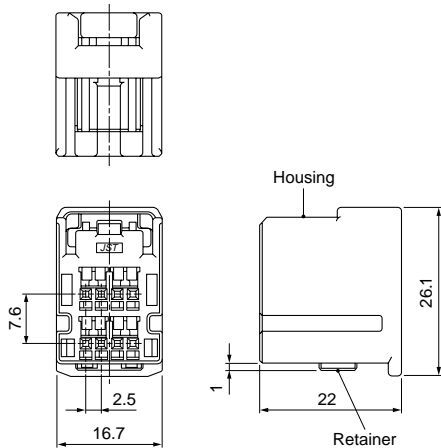

• 16 circuits

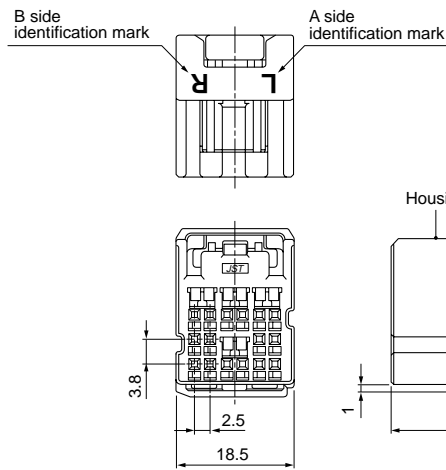

Model No.	
16CIT-B-1A	16CIT-B-2A
A figure	B figure

• 23 circuits

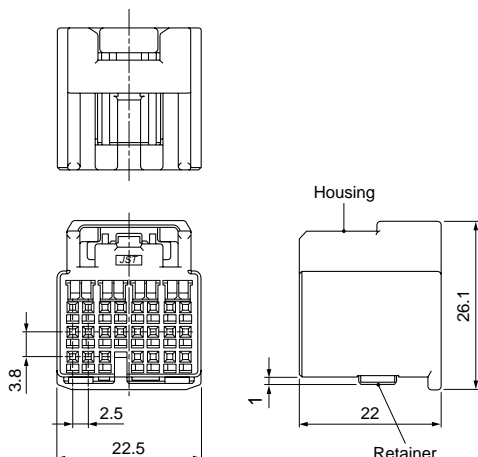

Circuits	Model No.	Q'ty/box
8	08CIT-B-1A	84
16	16CIT-B-1A	72
	16CIT-B-2A	72
23	23CIT-B-1A	60

Material and Finish

- Housing: PBT, yellow
- Lock housing: Glass-filled PBT, yellow
- Short terminal: Copper alloy, nickel-undercoated,
Contact area; gold-plated
- CPA terminal: Copper alloy, nickel-undercoated,
Contact area; gold-plated
- Retainer: PBT, natural (white)

Male connector

Dip type

• 36 circuits

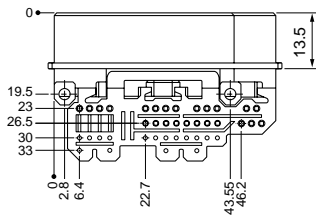
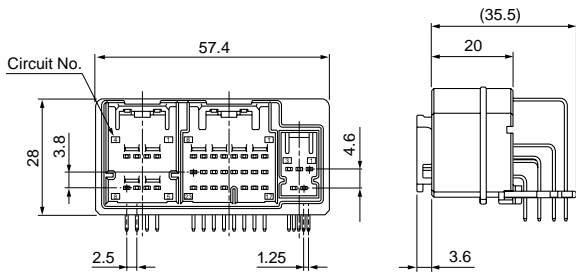

• 60 circuits

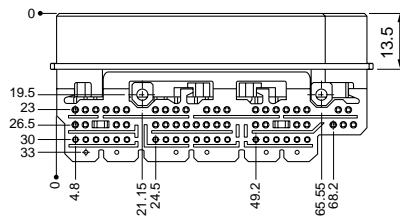
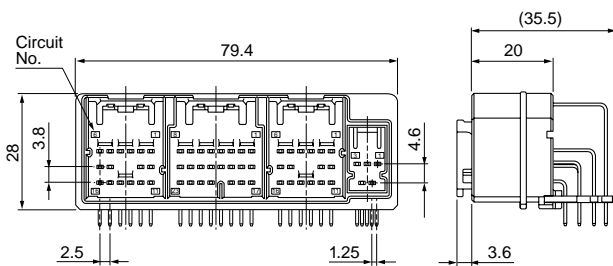

Press-fit type

• 60 circuits

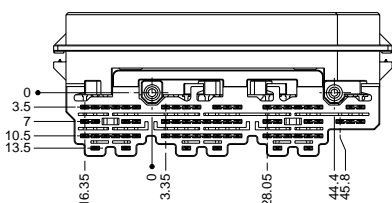
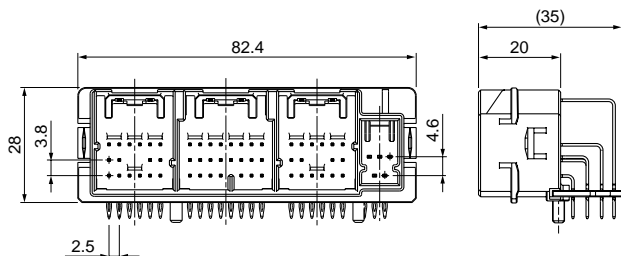

Dip type

Circuits	Model No.	Q'ty/box
36	S36B-CITYTP-01B	126
60	S60B-CITYTP-01B	98

Material and Finish

0.64 pin: Brass, nickel-undercoated, tin-plated (reflow treatment)
 1.0 pin: Brass, nickel-undercoated, tin-plated (reflow treatment)
 CPA pin: Brass, nickel-undercoated, Contact area; gold-plated
 Solder tail; tin-plated (reflow treatment)

Housing: Glass-filled PBT, yellow
 Tine-plate: Glass-filled PBT, natural (white)
 Protect cap: PBT, yellow

Press-fit type

Circuits	Model No.	Q'ty/box
60	S60B-CITYTP-P-04B	60

Material and Finish

0.64 pin(S, M): Phosphor bronze, nickel-undercoated, tin-plated (reflow treatment)
 0.64 pin(L): Phosphor bronze, nickel-undercoated, Contact area; gold-plated
 Press-fit area; tin-plated (reflow treatment)
 1.0 pin(S, M): Phosphor bronze, nickel-undercoated, tin-plated (reflow treatment)
 CPA pin: Phosphor bronze, nickel-undercoated, Contact area; gold-plated
 Press-fit area; tin-plated (reflow treatment)

Housing: Glass-filled PBT, yellow
 Tine-plate: Glass-filled PBT, natural (white)
 Protect cap: PBT, yellow

PC board layout, Assembly layout

Dip type

● 36 circuits

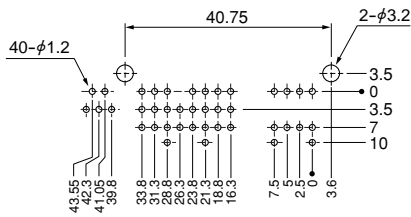

● 60 circuits

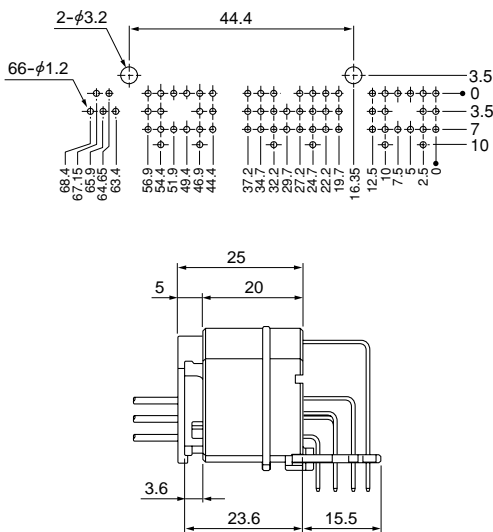

Press-fit type

● 60 circuits

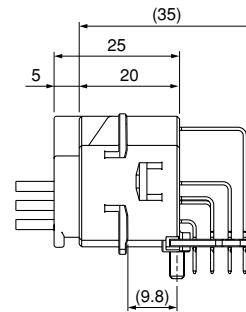
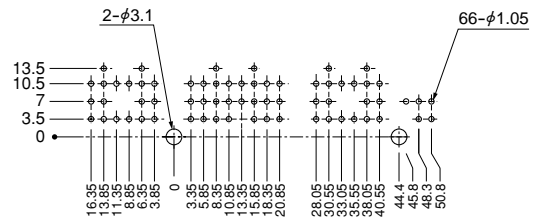

Note: 1. Tolerances are non-cumulative: ± 0.05 mm for all centers.
 2. Hole dimensions differ according to the type of PC board and piercing method.
 The dimensions above should serve as guideline. Contact JST for details.

Crimping machine, Applicator, Hand crimp tool

Strip terminal	Crimping machine	Crimp applicator MKS-L		Hand crimp tool	Applicable wire
		Dies	Crimp applicator with dies		
SNAC3-A001T-M0.64	AP-K2N	MK/SNAC3-A001-064	APLMK SNAC3-A001-064	—	—
SNAC3-A011T-M0.64		MK/SNAC3-A011-064	APLMK SNAC3-A011-064	—	—
SNAC3-A021T-M0.64		MK/SNAC3-A021-064	APLMK SNAC3-A021-064	YRK-1003	AVSS0.5, CAVS0.5
SNAC3-A021GI-M0.64-1				—	—
SNAC3-A021GF-M0.64-1				—	—

Note: When crimping operation is conducted using an applicator and die set other than the above, JST cannot guarantee the performance of the terminal.