

174879-2 ✓ ACTIVE

AMP | Econoseal, Econoseal J - Mark II

TE Internal #: 174879-2

Housing for Male Terminals, Wire-to-Wire, 1 Position, Sealable, Black, Signal, Cable Mount (Free-Hanging), -22 – 221 °F [-30 – 105 °C], Hybrid

[View on TE.com >](#)



Connectors > Automotive Connectors > Connector Housings > ECONOSEAL, CONNECTOR HOUSING

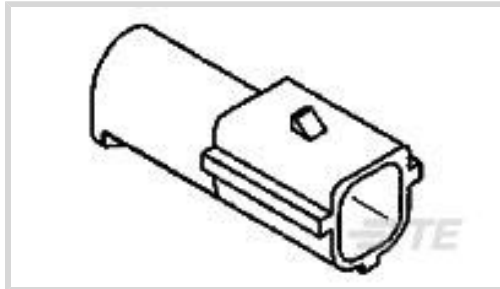

Connector & Housing Type: **Housing for Male Terminals**

Mating Tab Width: **1.8 mm [.071 in]**

Connector System: **Wire-to-Wire**

Number of Positions: **1**

Sealable: **Yes**

[All ECONOSEAL, CONNECTOR HOUSING \(90\)](#)

Features

Product Type Features

Connector & Housing Shape	Rectangular
Connector & Housing Type	Housing for Male Terminals
Connector System	Wire-to-Wire
Sealable	Yes
Hybrid Connector	No
Primary Locking Feature	Integrated in Housing

Configuration Features

Number of Positions	1
Number of Rows	1

Electrical Characteristics

Operating Voltage	12 VDC
Nominal Voltage Architecture	12 V

Body Features

Cable Exit Angle	180°
Body Material	PBT
Primary Product Color	Black



Contact Features

Contact Size	1.8mm
Contact Type	Tab
Mating Tab Width	1.8 mm[.071 in]

Mechanical Attachment

Mounting Feature	Without
Terminal Position Assurance	Yes
Strain Relief	Without
Mating Alignment Type	Polarization Slot
Mating Alignment	With
Connector Mounting Type	Cable Mount (Free-Hanging)

Dimensions

Product Width	13.5 mm[.531 in]
Product Length	32.5 mm[1.28 in]
Product Height	14.2 mm[.559 in]

Usage Conditions

Operating Temperature (Max)	70 °C, 75 °C, 80 °C, 85 °C, 90 °C, 100 °C, 105 °C[158 °F][167 °F][176 °F][185 °F][194 °F][212 °F][221 °F]
Operating Temperature Range	-30 – 105 °C[-22 – 221 °F]

Operation/Application

Circuit Application	Signal
---------------------	--------

Industry Standards

UL Flammability Rating	UL 94V-2
------------------------	----------

Packaging Features

Packaging Quantity	100
Packaging Method	Bag

Other

Serviceable	Yes
Connector Position Assurance Capable	No

Product Compliance

For compliance documentation, visit the product page on [TE.com](https://www.te.com)>



EU RoHS Directive 2011/65/EU	Compliant
EU ELV Directive 2000/53/EC	Compliant
China RoHS 2 Directive MIIT Order No 32, 2016	No Restricted Materials Above Threshold
EU REACH Regulation (EC) No. 1907/2006	Current ECHA Candidate List: JUNE 2022 (224) Candidate List Declared Against: JAN 2022 (223) SVHC > Threshold: Not Yet Reviewed
Halogen Content	Not Low Halogen - contains Br or Cl > 900 ppm.
Solder Process Capability	Not applicable for solder process capability

Product Compliance Disclaimer

This information is provided based on reasonable inquiry of our suppliers and represents our current actual knowledge based on the information they provided. This information is subject to change. The part numbers that TE has identified as EU RoHS compliant have a maximum concentration of 0.1% by weight in homogenous materials for lead, hexavalent chromium, mercury, PBB, PBDE, DBP, BBP, DEHP, DIBP, and 0.01% for cadmium, or qualify for an exemption to these limits as defined in the Annexes of Directive 2011/65/EU (RoHS2). Finished electrical and electronic equipment products will be CE marked as required by Directive 2011/65/EU. Components may not be CE marked. Additionally, the part numbers that TE has identified as EU ELV compliant have a maximum concentration of 0.1% by weight in homogenous materials for lead, hexavalent chromium, and mercury, and 0.01% for cadmium, or qualify for an exemption to these limits as defined in the Annexes of Directive 2000/53/EC (ELV). Regarding the REACH Regulation, the information TE provides on SVHC in articles for this part number is based on the latest European Chemicals Agency (ECHA) 'Guidance on requirements for substances in articles' posted at this URL: <https://echa.europa.eu/guidance-documents/guidance-on-reach>

Compatible Parts



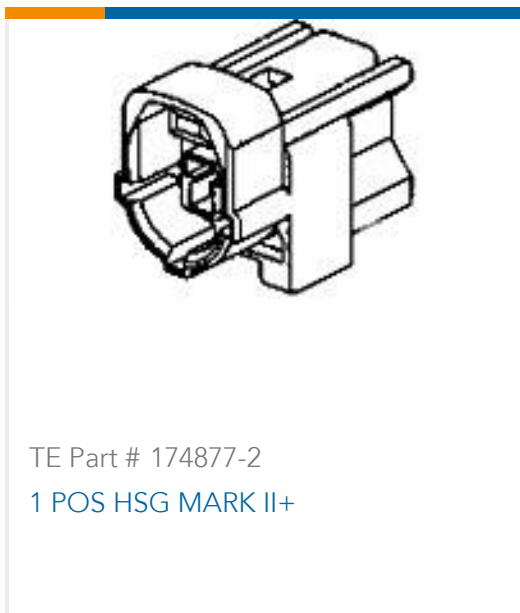

Also in the Series | Econoseal

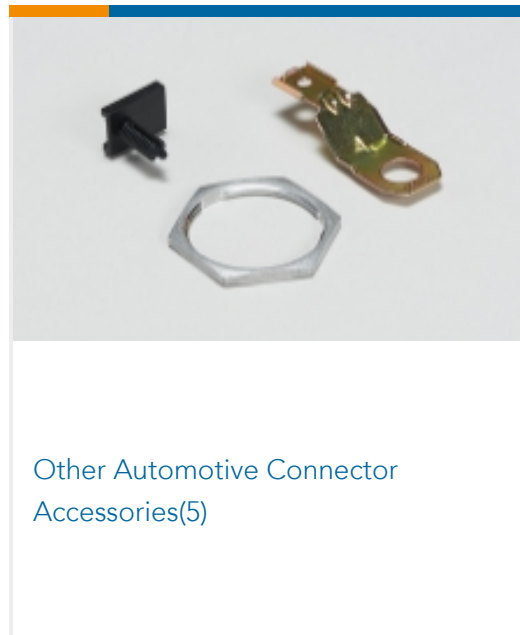
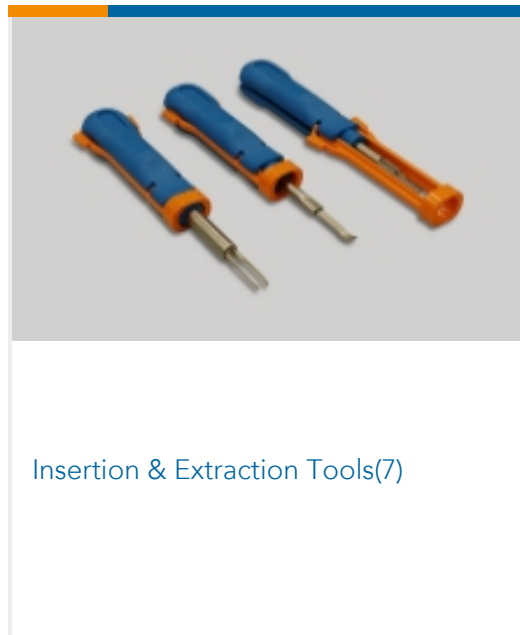
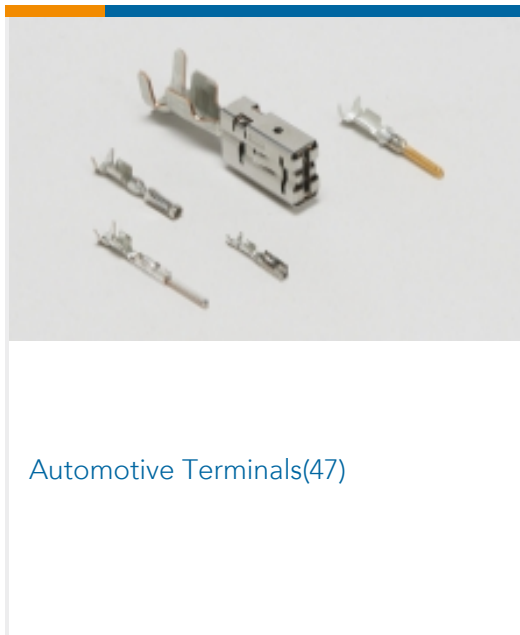
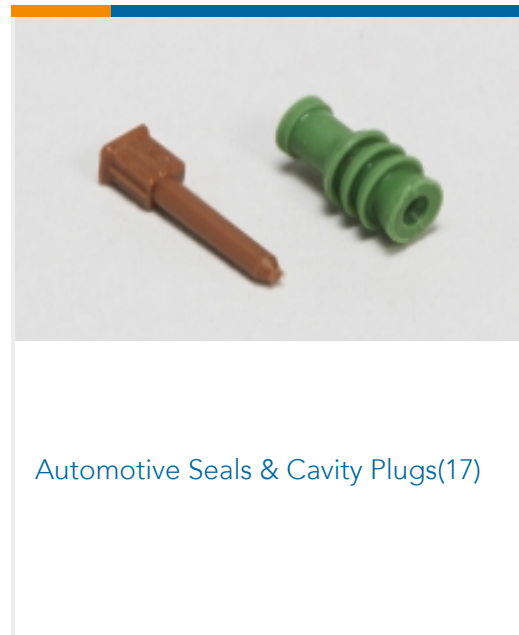
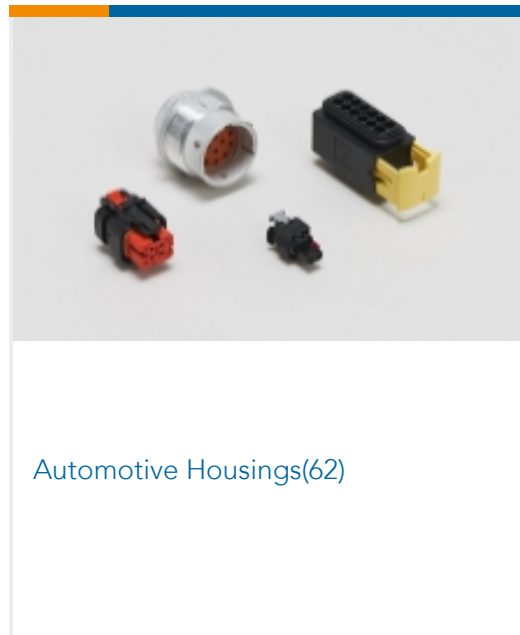
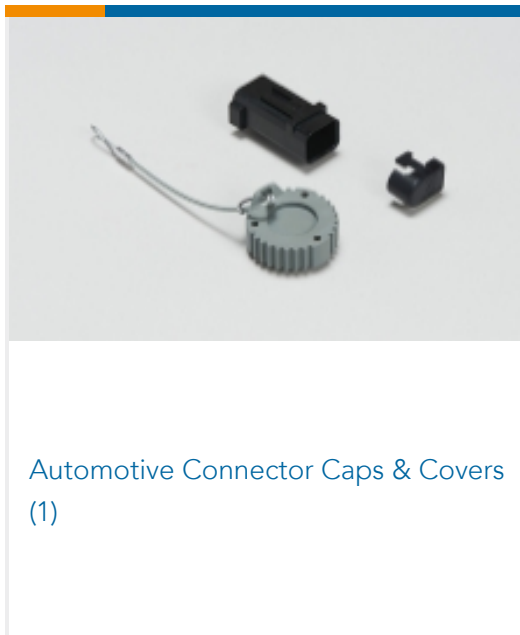

Also in the Series | Econoseal J - Mark II

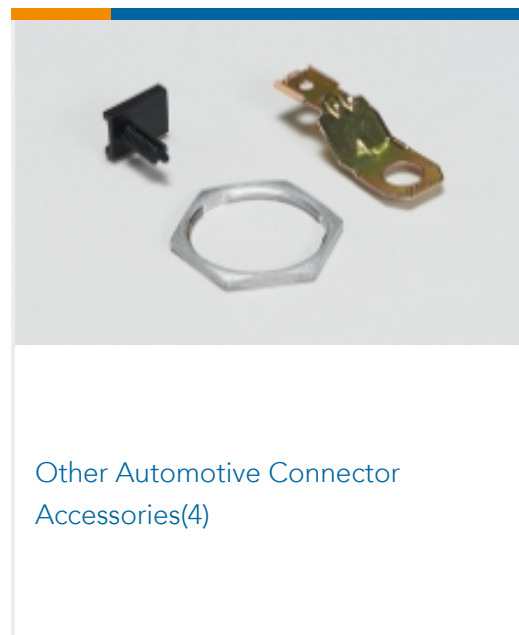
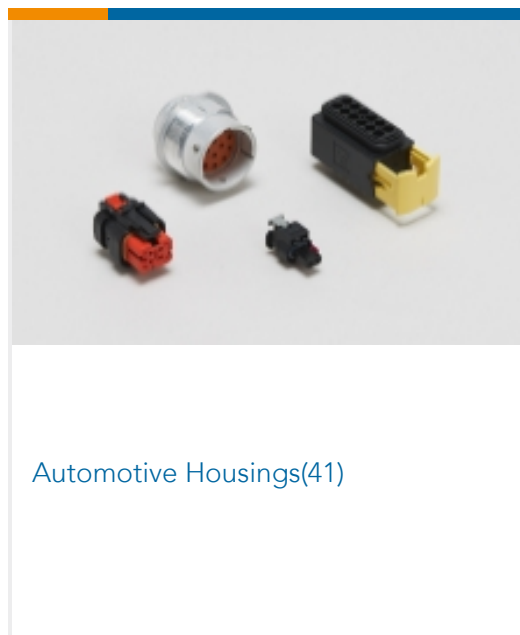

Customers Also Bought

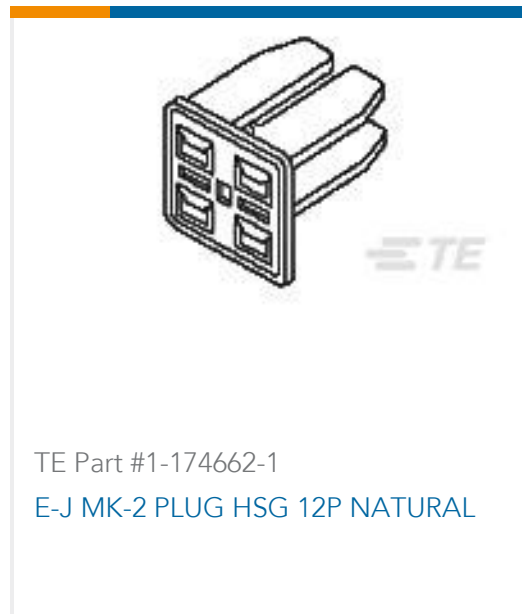

Documents

Product Drawings

1 POS HSG MARK II+

English

CAD Files

Customer View Model

[ENG_CVM_174879-2_B.3d_igs.zip](#)

English

3D PDF

English

Customer View Model

[ENG_CVM_174879-2_B.3d_stp.zip](#)

English

Customer View Model

[ENG_CVM_174879-2_B.2d_dxf.zip](#)

English

By downloading the CAD file I accept and agree to the [Terms and Conditions](#) of use.

Datasheets & Catalog Pages

Econoseal Connector Series

English

Product Specifications

Product Specification

English

Product Specification

Japanese



Product Environmental Compliance

Product Compliance

English

Product Compliance

English

Instruction Sheets

ECONOSEAL J MARK II+ CONNECTOR (EJ-MK II+)

English

Customer Manual (non U.S.)

English

ECONOSEAL J MARK II+ CONNECTOR

English

Customer Manual (non U.S.)

English

Agency Approvals

Agency Approval Document

English