

160773-4 ✓ ACTIVE

[Positive Lock](#) | [Positive Lock 250](#)

TE Internal #: 160773-4

Quick Disconnects, Receptacle, 20 – 15 AWG Wire Size, .51 – 1.65 mm² Wire Size, Mating Tab Width .25 in [6.35 mm], Straight, Positive Lock 250

[View on TE.com >](#)



Terminals & Splices > Quick Disconnects

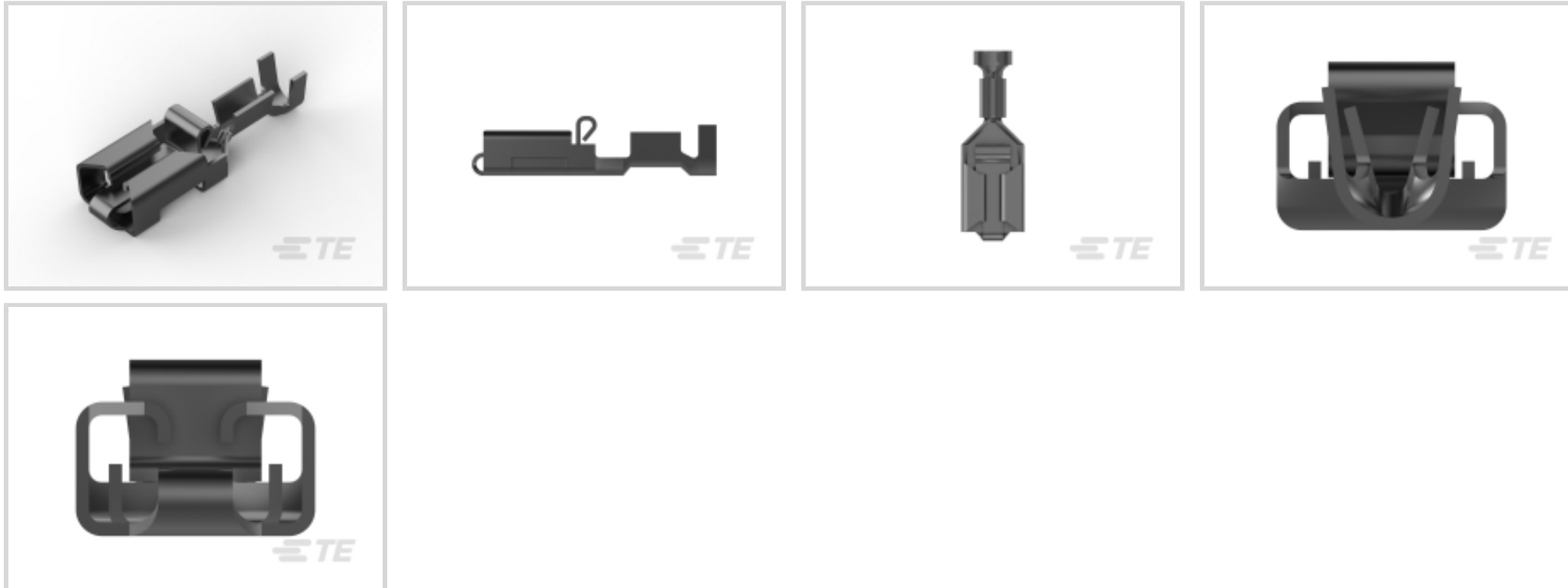

Quick Disconnect Terminal Type: **Receptacle**

Wire Size: .51 – 1.65 mm²

Mating Tab Width: 6.35 mm [.25 in]

Mating Tab Thickness: .81 mm [.032 in]

Features

Product Type Features

Terminates To	Wire & Cable
Wire Stop	No
Wire/Cable Type	Discrete Wire
Insertion Force	Low
Sealable	No

Contact Features

Quick Disconnect Terminal Type	Receptacle
Mating Tab Width	6.35 mm [.25 in]
Mating Tab Thickness	.81 mm [.032 in]
Terminal Orientation	Straight
Contact Base Material	Phosphor Bronze
Terminal Plating Material	Tin
Crimp Type	F-Crimp
Barrel Type	Open

Mechanical Attachment



Mating Retention Type	Dimple
Extraction Force	7 – 100 Newton
Wire Insulation Support	With

Dimensions

Accepts Wire Insulation Diameter Range	2.3 – 3.3 mm [.09 – .13 in]
Overall Length	22.9 mm [.901 in]
Receptacle Terminal Stock Thickness	.4 mm [.015 in]
Wire Size	.51 – 1.65 mm ²

Usage Conditions

Insulation Option	Uninsulated
Operating Temperature Range	-40 – 110 °C [-40 – 230 °F]

Industry Standards

UL Rating	Recognized
-----------	------------

Packaging Features

Packaging Quantity	500
Packaging Method	Loose Piece/Carton

Other

Comment	FLK-Wire: Normal Wire
---------	-----------------------

Product Compliance

[For compliance documentation, visit the product page on TE.com>](#)

EU RoHS Directive 2011/65/EU	Compliant
EU ELV Directive 2000/53/EC	Compliant
China RoHS 2 Directive MIIT Order No 32, 2016	No Restricted Materials Above Threshold
EU REACH Regulation (EC) No. 1907/2006	Current ECHA Candidate List: JUNE 2022 (224) Candidate List Declared Against: JAN 2022 (223) SVHC > Threshold: Not Yet Reviewed
Halogen Content	Low Halogen - Br, Cl, F, I < 900 ppm per homogenous material. Also BFR/CFR/PVC Free
Solder Process Capability	Not applicable for solder process capability

Product Compliance Disclaimer

This information is provided based on reasonable inquiry of our suppliers and represents our current actual knowledge based on the information they provided. This information is subject to change. The part numbers that TE has identified as EU RoHS compliant have a maximum concentration of 0.1% by weight in homogenous materials for lead, hexavalent chromium, mercury, PBB, PBDE, DBP, BBP, DEHP, DIBP, and 0.01% for cadmium, or qualify for an exemption to these limits as defined in the Annexes of Directive 2011/65/EU (RoHS2). Finished electrical and electronic equipment products will be CE marked as required by Directive 2011/65/EU. Components may not be CE marked. Additionally, the part numbers that TE has identified as EU ELV compliant have a maximum concentration of 0.1% by weight in homogenous materials for lead, hexavalent chromium, and mercury, and 0.01% for cadmium, or qualify for an exemption to these limits as defined in the Annexes of Directive 2000/53/EC (ELV). Regarding the REACH Regulation, the information TE provides on SVHC in articles for this part number is based on the latest European Chemicals Agency (ECHA) 'Guidance on requirements for substances in articles' posted at this URL: <https://echa.europa.eu/guidance-documents/guidance-on-reach>

Compatible Parts



TE Part # 654174-1
POS.LOCK HANDTOOL



TE Part # 539671-2
MATRIZE SNAP-IN



TE Part # 927882-8
POS LOCK RECEPTACLE 6,3

Also in the Series | Positive Lock 250

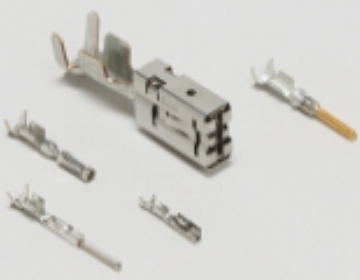

Automotive Terminals(1)



Crimp Terminal Housings(203)



Insertion & Extraction Tools(3)



Insulation Boots & Sleeves(4)



Quick Disconnects(189)

Customers Also Bought



TE Part #1056030001
D-SCE FLUID RESISTANT SLEEVES



TE Part #621060-000
D-142-56



TE Part #63232-1
POSITIVE LOCK 187 REC 20-16 AWG
TPBR



TE Part #154719-5
PL 250 REC HSG 1P NYLON GREEN



TE Part #280621-1
MOD I CRIMP CONTACT

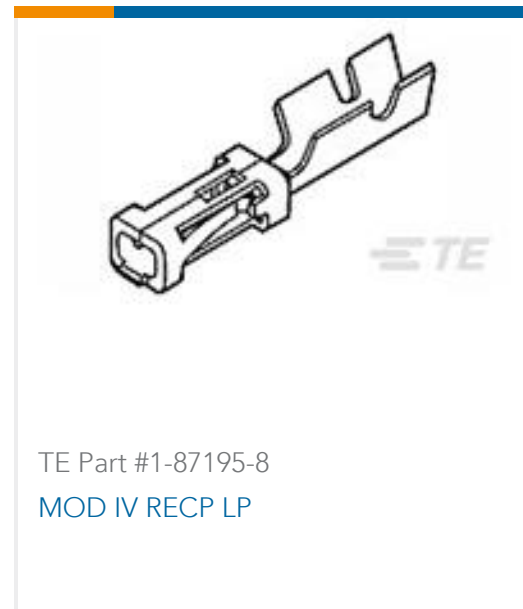

TE Part #1-87195-8
MOD IV RECP LP



TE Part #1SNA162988R2100
HD6/14.SDH.1

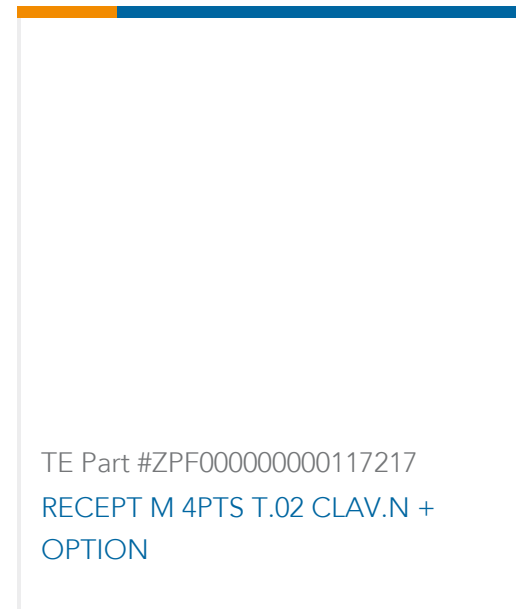

TE Part #ZPF00000000117217
RECEPT M 4PTS T.02 CLAV.N +
OPTION



TE Part #ZPF00000000112510
CONTACT FEMALE 1,6 - 0,35 TO 1,82
MM2 S/A

Documents

Product Drawings

[PL LP RECEPTACLE 0.5-1.5 MM2 TPPHBZ](#)

English

CAD Files

[3D PDF](#)

3D

Customer View Model

[ENG_CVM_CVM_160773-4_D.2d_dxf.zip](#)

English

Customer View Model

[ENG_CVM_CVM_160773-4_D.3d_igs.zip](#)

English

Customer View Model

[ENG_CVM_CVM_160773-4_D.3d_stp.zip](#)

English

By downloading the CAD file I accept and agree to the [Terms and Conditions](#) of use.

Datasheets & Catalog Pages



1654742_HOUSEHOLD_APPLIANCES_RAST5

English

Product Specifications

Application Specification

English

Product Environmental Compliance

TE Material Declaration

English