

1586852-1 ✓ ACTIVE

MATE-N-LOK | Universal MATE-N-LOK

TE Internal #: 1586852-1

Rectangular Power Connectors, Housing, Plug, Wire-to-Wire / Wire-to-Board, 4 Position, .25 in [6.35 mm] Centerline, Wire & Cable, Universal MATE-N-LOK

[View on TE.com >](#)



Connectors > Power Connectors > Rectangular Power > Rectangular Power Connectors



Rectangular Power Connector Type: **Housing**

Connector & Housing Type: **Plug**

Connector System: **Wire-to-Board, Wire-to-Wire**

Number of Positions: **4**

Centerline (Pitch): **6.35 mm [.25 in]**

Features

Product Type Features

Rectangular Power Connector Type	Housing
Connector & Housing Type	Plug
Connector System	Wire-to-Board, Wire-to-Wire
Sealable	No
Connector & Contact Terminates To	Wire & Cable

Configuration Features

Number of Positions	4
Number of Rows	1

Electrical Characteristics

Operating Voltage	600 VAC
-------------------	---------

Contact Features

Multiple Contact Types	Without
Contact Layout	Inline
Contact Retention Within Housing	Without



Contact Type	Socket
--------------	--------

Termination Features

Termination Method to Wire & Cable	Crimp
------------------------------------	-------

Mechanical Attachment

Connector Mounting Type	Cable Mount (Free-Hanging)
-------------------------	----------------------------

Housing Features

Centerline (Pitch)	6.35 mm [.25 in]
--------------------	------------------

Housing Color	Natural
---------------	---------

Housing Material	Nylon
------------------	-------

Dimensions

	.03 – .09 in
--	--------------

Usage Conditions

Operating Temperature Range	-55 – 105 °C [-67 – 221 °F]
-----------------------------	-----------------------------

Operation/Application

Assembly Integration Feature	Without
------------------------------	---------

Circuit Application	Power & Signal
---------------------	----------------

Industry Standards

CSA Rating	Certified
------------	-----------

UL Flammability Rating	UL 94V-2
------------------------	----------

Glow Wire Rating	GWT 750°C (Without Flame)
------------------	---------------------------

UL Rating	Recognized
-----------	------------

Agency/Standard Number	E28476
------------------------	--------

CSA File Number	LR7189
-----------------	--------

VDE Tested	Yes
------------	-----

Agency/Standard	CSA, UL
-----------------	---------

Packaging Features

Packaging Method	Package
------------------	---------

Packaging Quantity	1
--------------------	---

Other

For Use With	Appropriate Universal MATE-N-LOK Cap or Header
--------------	--



Product Compliance

[For compliance documentation, visit the product page on TE.com>](#)

EU RoHS Directive 2011/65/EU	Compliant
EU ELV Directive 2000/53/EC	Compliant
China RoHS 2 Directive MIIT Order No 32, 2016	No Restricted Materials Above Threshold
EU REACH Regulation (EC) No. 1907/2006	Current ECHA Candidate List: JUNE 2022 (224) Candidate List Declared Against: JAN 2022 (223) SVHC > Threshold: Not Yet Reviewed
Halogen Content	Not Low Halogen - contains Br or Cl > 900 ppm.
Solder Process Capability	Not applicable for solder process capability

Product Compliance Disclaimer

This information is provided based on reasonable inquiry of our suppliers and represents our current actual knowledge based on the information they provided. This information is subject to change. The part numbers that TE has identified as EU RoHS compliant have a maximum concentration of 0.1% by weight in homogenous materials for lead, hexavalent chromium, mercury, PBB, PBDE, DBP, BBP, DEHP, DIBP, and 0.01% for cadmium, or qualify for an exemption to these limits as defined in the Annexes of Directive 2011/65/EU (RoHS2). Finished electrical and electronic equipment products will be CE marked as required by Directive 2011/65/EU. Components may not be CE marked. Additionally, the part numbers that TE has identified as EU ELV compliant have a maximum concentration of 0.1% by weight in homogenous materials for lead, hexavalent chromium, and mercury, and 0.01% for cadmium, or qualify for an exemption to these limits as defined in the Annexes of Directive 2000/53/EC (ELV). Regarding the REACH Regulation, the information TE provides on SVHC in articles for this part number is based on the latest European Chemicals Agency (ECHA) 'Guidance on requirements for substances in articles' posted at this URL: <https://echa.europa.eu/guidance-documents/guidance-on-reach>

Compatible Parts

 <p>TE Part # 640585-1 06P UMNL PLUG HSG V2 NATL</p>	 <p>TE Part # 1-480703-9 04P UMNL CAP HSG BLK</p>	 <p>TE Part # 770026-1 04P UMNLI IN-LINE CAP HSG KIT</p>	 <p>TE Part # 2-480700-0 03P UMNL PLUG HSG</p>
---	--	---	---



TE Part # 350780-1
04P UMNL CAP HSG



TE Part # 1586845-1
04P UMNL CAP HSG NATL, GW



TE Part # 640586-1
08P UMNL PLUG HSG V2 NATL



TE Part # 1-480763-0
05P UMNL PLUG HSG NATL



TE Part # 1-480702-0
04P UMNL PLUG HSG NATL



TE Part # 794899-1
04P UMNL HI TEMP PLUG HSG



TE Part # 926305-6
UNML4WAY CAP



TE Part # 926305-7
4P UNIV M-N-L CAP



TE Part # 794814-1
02P UMNL PLUG HSG, HI TEMP



TE Part # 1586847-1
03P UMNL PLUG HSG, GW



TE Part # 1586851-1
02P UMNL PLUG HSG, GW



TE Part # 1-480703-1
04P UMNL CAP HSG BRN



TE Part # 1586702-1
02P UMNL PLUG HSG NATL LEAD IN



TE Part # 2-480703-0
04P UMNL CAP HSG NATL



TE Part # 794707-1
04P UMNL CAP HSG, BLACK



TE Part # 1-480703-0
04P UMNL CAP HSG NATL

Also in the Series | **Universal MATE-N-LOK**



Circular Power Connectors(2)



Connector Contacts(11)



Insertion & Extraction Tools(4)



Power Contacts(207)

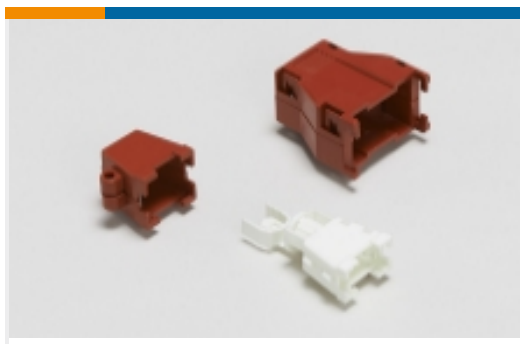

Rectangular Boots & Strain Relief(35)

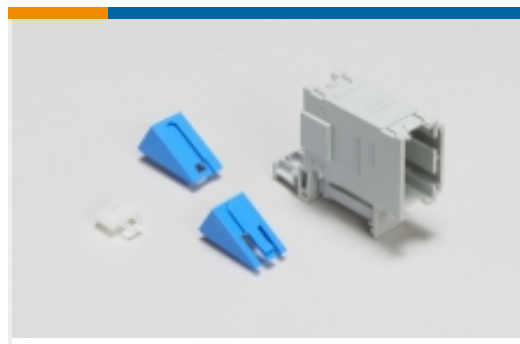

Rectangular Connector Adapters(7)

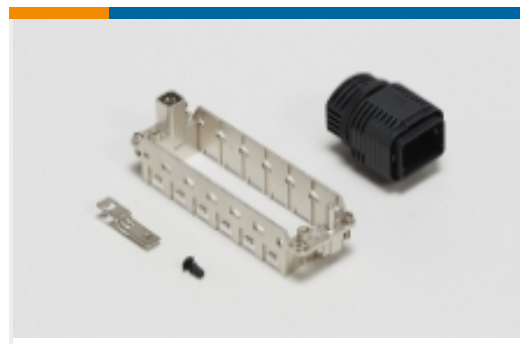

Rectangular Connector Hardware(1)



Rectangular Connector Housings(2)

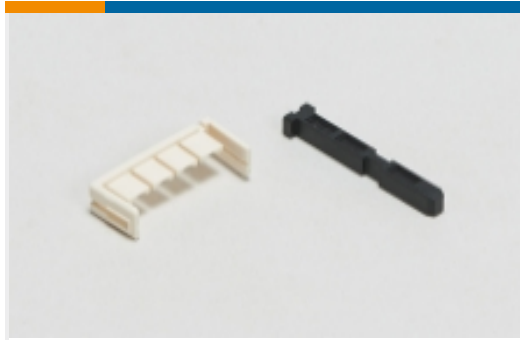

Rectangular Connector Keying Plugs(3)



Rectangular Connector Locking(4)



Rectangular Connector Seals(26)



Rectangular Power Connectors(729)

Customers Also Bought

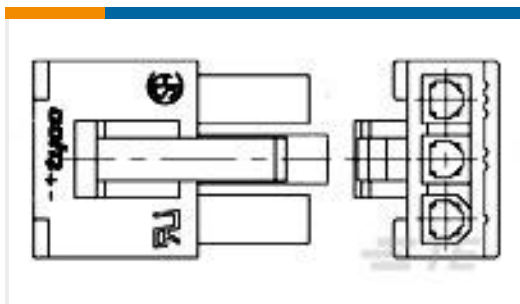

TE Part #2029112-3
3P RCPT SR VAL-U-LOK GW



TE Part #42617-1
187 FASTON REC 20-16 AWG BR



TE Part #1586851-1
02P UMNL PLUG HSG, GW

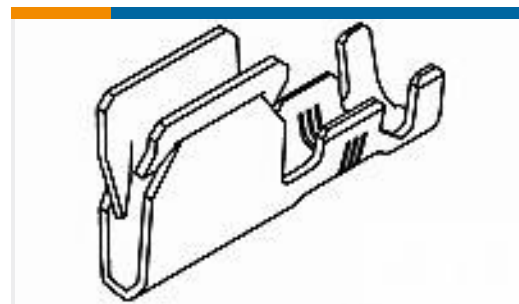

TE Part #63895-1
GROUND CLIP 14-18AWG ST



TE Part #63482-1
RING 18-14 AWG TPSTL

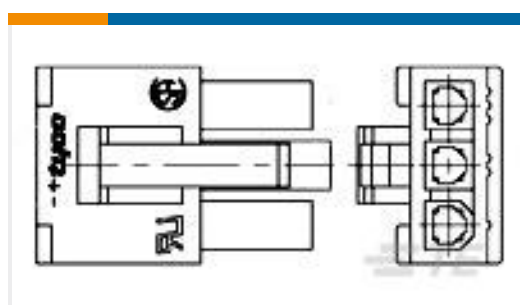

TE Part #2029178-5
5P SR RCPT VAL-U-LOK GW



TE Part #40509
SPLICE 3300 TO 9000 CMA BR

Documents

Product Drawings

[04P UMNL PLUG HSG, GW](#)

English

CAD Files

[3D PDF](#)

3D

Customer View Model

[ENG_CVM_CVM_1586852-1_B.2d_dxf.zip](#)



English

Customer View Model

[ENG_CVM_CVM_1586852-1_B.3d_igs.zip](#)

English

Customer View Model

[ENG_CVM_CVM_1586852-1_B.3d_stp.zip](#)

English

Customer View Model

[ENG_CVM_1586852-1_A.3d_igs.zip](#)

English

Customer View Model

[ENG_CVM_1586852-1_A.3d_stp.zip](#)

English

Customer View Model

[ENG_CVM_1586852-1_A.2d_dxf.zip](#)

English

[3D PDF](#)

English

By downloading the CAD file I accept and agree to the [Terms and Conditions](#) of use.

Product Environmental Compliance

[MD_1586852-1_061220181035_dmtec](#)

English

[MD_1586852-1_061220181035_dmtec](#)

English

Agency Approvals

[CSA Certificate](#)

English