

1-535512-8 ✓ ACTIVE

AMPMODU | Modu Connector System

TE Internal #: 1-535512-8

PCB Mount Receptacle, Right Angle, Board-to-Board, 16 Position, .1 in [2.54 mm] Centerline, Gold, Through Hole - Solder, Signal, Modu Connector System

[View on TE.com >](#)



Connectors > PCB Connectors > PCB Headers & Receptacles

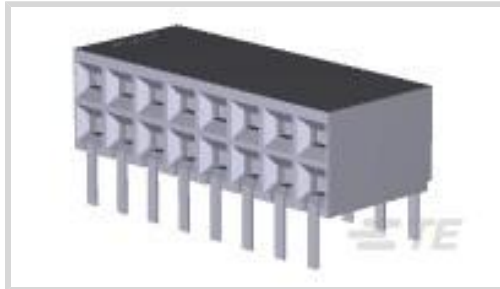

PCB Connector Assembly Type: **PCB Mount Receptacle**

PCB Mount Orientation: **Right Angle**

Connector System: **Board-to-Board**

Number of Positions: **16**

Number of Rows: **2**

Features

Product Type Features

Applied Pressure	High, Standard
PCB Connector Assembly Type	PCB Mount Receptacle
Connector System	Board-to-Board
Sealable	No
Connector & Contact Terminates To	Printed Circuit Board

Configuration Features

Stackable	Yes
PCB Mount Orientation	Right Angle
Number of Positions	16
Number of Rows	2

Electrical Characteristics

Dielectric Withstanding Voltage (Max)	750 VAC
Insulation Resistance	5000 MΩ
Operating Voltage	333 VAC

Body Features

Connector Profile	Standard
Primary Product Color	Black

Contact Features



Contact Protection Type	Closed Entry Housing
Contact Mating Area Length	3 mm[.1 in]
Mating Square Post Dimension	.64 mm[.025 in]
PCB Contact Termination Area Plating Material Thickness	1.27 µm
Contact Shape & Form	Short Point
PCB Contact Termination Area Plating Material	Tin-Lead
Contact Base Material	Phosphor Bronze
Contact Mating Area Plating Material	Gold
Contact Mating Area Plating Material Thickness	.762 µm[30 µin]
Contact Type	Socket
Contact Current Rating (Max)	2 A

Termination Features

Rectangular Termination Post & Tail Thickness	.2 mm[.008 in]
Rectangular Termination Post & Tail Width	.69 mm[.027 in]
Termination Post & Tail Length	2.92 mm[.115 in]
Termination Method to Printed Circuit Board	Through Hole - Solder

Mechanical Attachment

Mating Alignment	Without
PCB Mount Retention	Without
PCB Mount Alignment	Without
Connector Mounting Type	Board Mount

Housing Features

Mating Entry Location	Side
Centerline (Pitch)	2.54 mm[.1 in]
Housing Material	Polyester - GF

Dimensions

Connector Height	6.05 mm[.238 in]
Row-to-Row Spacing	2.54 mm, 7.87 mm[.31 in]
Stack Height	8.13 mm[.32 in]
PCB Thickness (Recommended)	1.4 – 2.4 mm[.055 – .094 in]

Usage Conditions

Housing Temperature Rating	High
----------------------------	------



Operating Temperature Range -65 – 105 °C[-85 – 221 °F]

Operation/Application

Solder Process Feature	Board Standoff
Circuit Application	Signal

Industry Standards

Approved Standards	CSA LR7189, UL E28476
UL Flammability Rating	UL 94V-0

Packaging Features

Packaging Quantity	28
Packaging Type	Box, Tube

Product Compliance

[For compliance documentation, visit the product page on TE.com>](#)

EU RoHS Directive 2011/65/EU	Compliant
EU ELV Directive 2000/53/EC	Compliant
China RoHS 2 Directive MIIT Order No 32, 2016	No Restricted Materials Above Threshold
EU REACH Regulation (EC) No. 1907/2006	Current ECHA Candidate List: JUNE 2022 (224) Candidate List Declared Against: JAN 2022 (223) SVHC > Threshold: Not Yet Reviewed
Halogen Content	Not Low Halogen - contains Br or Cl > 900 ppm.
Solder Process Capability	Reflow solder capable to 260°C

Product Compliance Disclaimer

This information is provided based on reasonable inquiry of our suppliers and represents our current actual knowledge based on the information they provided. This information is subject to change. The part numbers that TE has identified as EU RoHS compliant have a maximum concentration of 0.1% by weight in homogenous materials for lead, hexavalent chromium, mercury, PBB, PBDE, DBP, BBP, DEHP, DIBP, and 0.01% for cadmium, or qualify for an exemption to these limits as defined in the Annexes of Directive 2011/65/EU (RoHS2). Finished electrical and electronic equipment products will be CE marked as required by Directive 2011/65/EU. Components may not be CE marked. Additionally, the part numbers that TE has identified as EU ELV compliant have a maximum concentration of 0.1% by weight in homogenous materials for lead, hexavalent chromium, and mercury, and 0.01% for cadmium, or qualify for an exemption to these limits as defined in the Annexes of Directive 2000/53/EC (ELV). Regarding the REACH Regulation, the information TE provides on SVHC in articles for this part number is based on the latest European Chemicals Agency (ECHA) 'Guidance on requirements for substances in articles' posted at this URL: <https://echa.europa.eu/guidance-documents/guidance-on-reach>

Compatible Parts



TE Part # 86479-2
16 MODII HDR DRRA UNSHRD .100

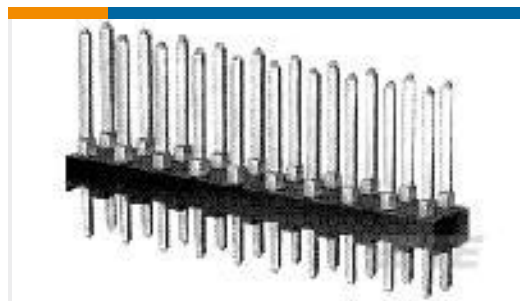

TE Part # 87215-5
16 MODII HDR DRST UNSHRD .100



TE Part # 2-86479-4
40 MODII HDR DRRA UNSHRD .100

Also in the Series | Modu Connector System



Automotive Housings(2)



Board-to-Board Jumpers & Shunts(5)

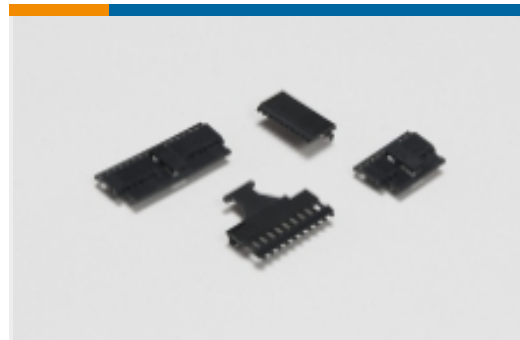

PCB Connector Covers(4)



PCB Connector Keying(4)

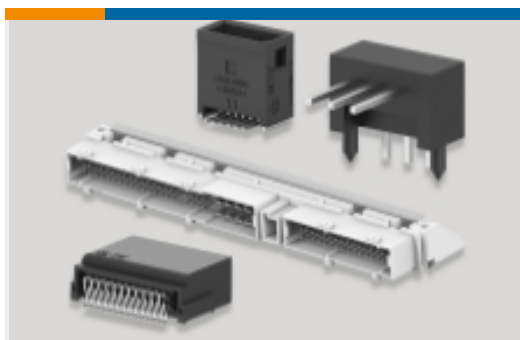

PCB Headers & Receptacles(1243)

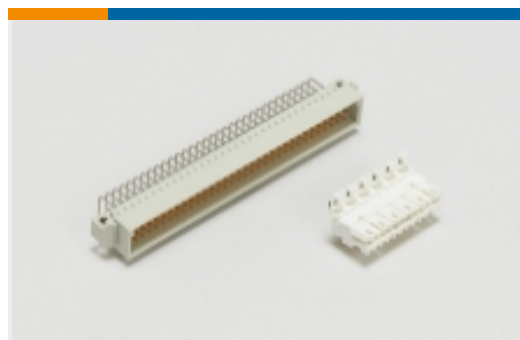

Standard Edge Connectors(2)

Customers Also Bought

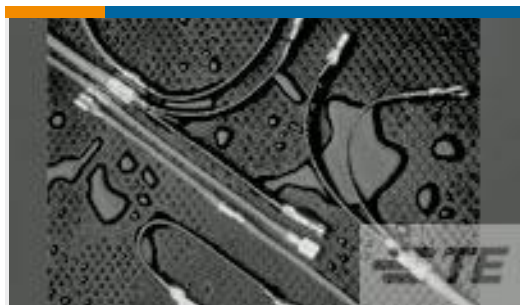

TE Part #201451-000
B-106-1993



TE Part #794219-1
MINI UMNL2 SOK 26-22 AWG SN



TE Part #794201-1
12P MINI UMNL2 CAP HSG MATRIX



TE Part #640913-2
RECEPT,PIDG FASTON 16-14 205



TE Part #2-34114-2
SOLIS R 22-16COMM22-18MIL 5/16

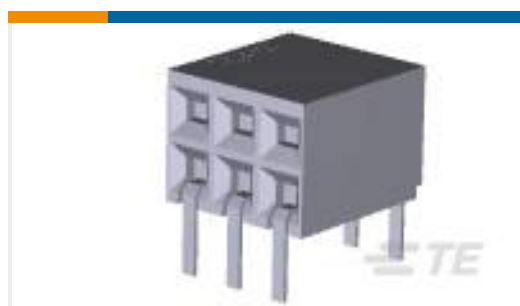

TE Part #6-535512-2
06 MODII HORZ DR CE EESS .100

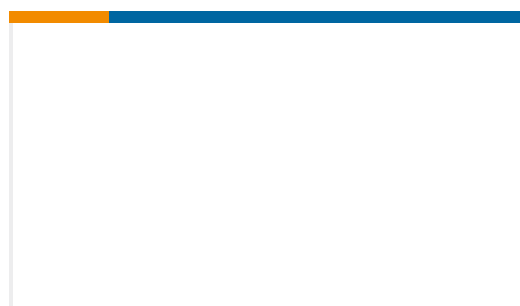

TE Part #345260-1
ANTI-BACKOUT 6WAY REC HSGECONO



TE Part #3-22278-8
SPRING,COMPRESSION



Documents

Product Drawings

[16 MODII HORZ DR CE EESS .100](#)

English

CAD Files

[3D PDF](#)

English

Customer View Model

[ENG_CVM_1-535512-8_Y1.3d_igs.zip](#)

English

Customer View Model

[ENG_CVM_1-535512-8_Y1.2d_dxf.zip](#)

English

Customer View Model

[ENG_CVM_1-535512-8_Y1.3d_stp.zip](#)

English

By downloading the CAD file I accept and agree to the [Terms and Conditions](#) of use.

Product Specifications

[Application Specification](#)

English

Product Environmental Compliance

[Product Compliance](#)

English

[Product Compliance](#)

English