

1586018-8 ✓ ACTIVE



VAL-U-LOK

TE Internal #: 1586018-8

Rectangular Power Connectors, Housing, Plug, Wire-to-Panel /
Wire-to-Wire, 8 Position, .165 in [4.2 mm] Centerline, Wire & Cable,
UL 94V-0

[View on TE.com >](#)

Connectors > Power Connectors > Rectangular Power > Rectangular Power Connectors



Rectangular Power Connector Type: **Housing**

Connector & Housing Type: **Plug**

Connector System: **Wire-to-Panel, Wire-to-Wire**

Number of Positions: **8**

Centerline (Pitch): **4.2 mm [.165 in]**

Features

Product Type Features

Rectangular Power Connector Type	Housing
Connector & Housing Type	Plug
Connector System	Wire-to-Panel, Wire-to-Wire
Sealable	No
Connector & Contact Terminates To	Wire & Cable

Configuration Features

Number of Positions	8
Number of Rows	2

Electrical Characteristics

Operating Voltage	600 VAC
-------------------	---------

Contact Features

Contact Layout	Matrix
Contact Retention Within Housing	Without
Contact Type	Pin



Termination Features

Termination Method to Wire & Cable	Crimp
Wire/Cable Type	Discrete Wire

Mechanical Attachment

Connector Mounting Type	Panel Mount
-------------------------	-------------

Housing Features

Centerline (Pitch)	4.2 mm[.165 in]
Housing Color	White
Housing Material	Nylon

Dimensions

Row-to-Row Spacing	4.2 mm[.165 in]
Width	23.9 mm[.94 in]
Accepts Wire Insulation Diameter Range	1.2 – 3.1 mm[.047 – .122 in]
Height	9.6 mm[.378 in]
Length	18 mm[.709 in]

Usage Conditions

Operating Temperature Range	-40 – 105 °C[-40 – 221 °F]
Insertion Force	15 Newton

Operation/Application

Assembly Integration Feature	Without
Circuit Application	Power & Signal

Identification Marking

Circuit Identification Feature	With
--------------------------------	------

Industry Standards

UL Flammability Rating	UL 94V-0
Glow Wire Rating	Standard Part - Not Glow Wire
Agency/Standard Number	E28476
Agency/Standard	CSA, UL
UL Rating	Recognized
CSA File Number	208567
VDE Tested	No



Packaging Features

Packaging Method	Bag
Packaging Quantity	500

Product Compliance

[For compliance documentation, visit the product page on TE.com>](#)

EU RoHS Directive 2011/65/EU	Compliant
EU ELV Directive 2000/53/EC	Compliant
China RoHS 2 Directive MIIT Order No 32, 2016	No Restricted Materials Above Threshold
EU REACH Regulation (EC) No. 1907/2006	Current ECHA Candidate List: JUNE 2022 (224) Candidate List Declared Against: JAN 2022 (223) SVHC > Threshold: Not Yet Reviewed
Halogen Content	Low Halogen - Br, Cl, F, I < 900 ppm per homogenous material. Also BFR/CFR/PVC Free
Solder Process Capability	Not applicable for solder process capability

Product Compliance Disclaimer

This information is provided based on reasonable inquiry of our suppliers and represents our current actual knowledge based on the information they provided. This information is subject to change. The part numbers that TE has identified as EU RoHS compliant have a maximum concentration of 0.1% by weight in homogenous materials for lead, hexavalent chromium, mercury, PBB, PBDE, DBP, BBP, DEHP, DIBP, and 0.01% for cadmium, or qualify for an exemption to these limits as defined in the Annexes of Directive 2011/65/EU (RoHS2). Finished electrical and electronic equipment products will be CE marked as required by Directive 2011/65/EU. Components may not be CE marked. Additionally, the part numbers that TE has identified as EU ELV compliant have a maximum concentration of 0.1% by weight in homogenous materials for lead, hexavalent chromium, and mercury, and 0.01% for cadmium, or qualify for an exemption to these limits as defined in the Annexes of Directive 2000/53/EC (ELV). Regarding the REACH Regulation, the information TE provides on SVHC in articles for this part number is based on the latest European Chemicals Agency (ECHA) 'Guidance on requirements for substances in articles' posted at this URL: <https://echa.europa.eu/guidance-documents/guidance-on-reach>

Compatible Parts

 <p>TE Part # 1586019-8 8P RCPT VAL-U-LOK V0</p>	 <p>TE Part # 1969614-8 8P RCPT VAL-U-LOK V0</p>
-----------------------------------------------------------------------------------------------------------------------------------------	-----------------------------------------------------------------------------------------------------------------------------------------

Customers Also Bought

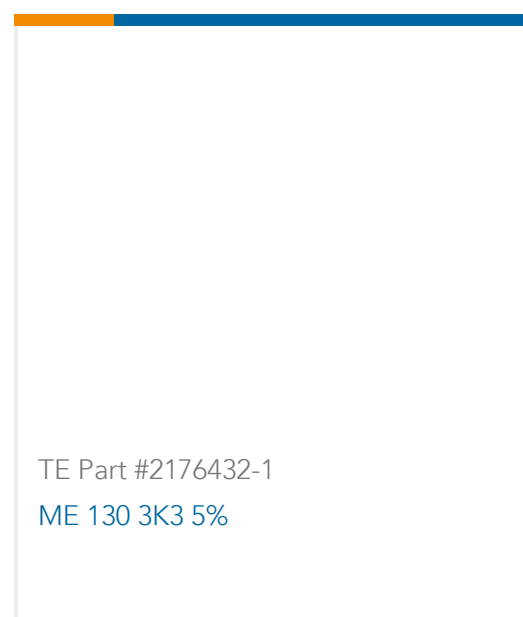
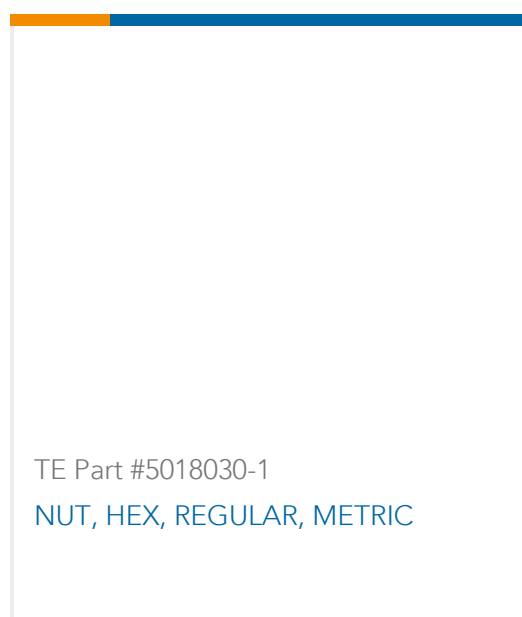
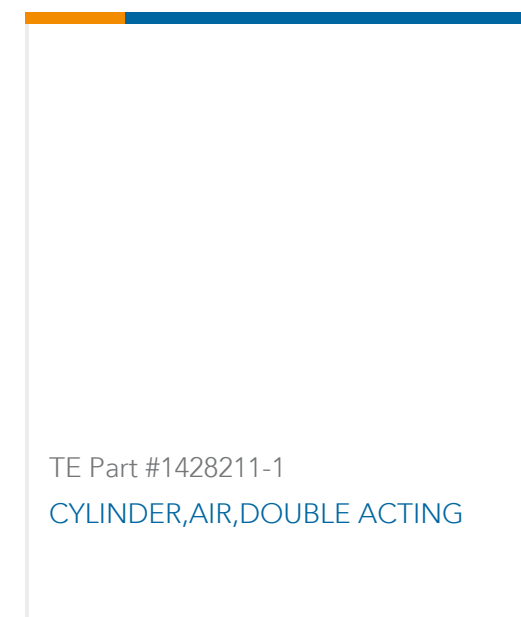
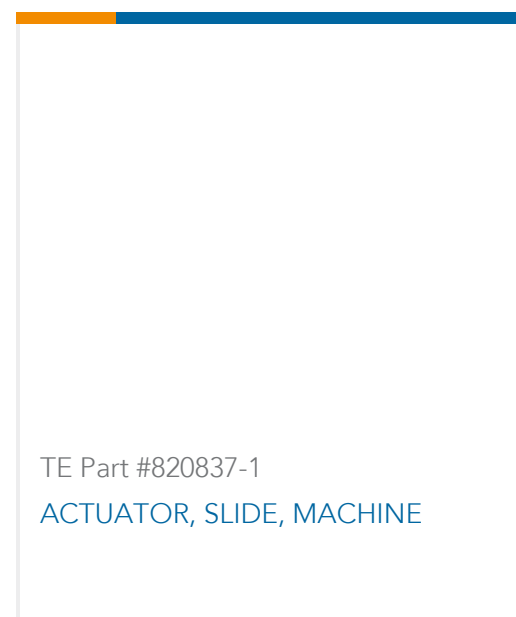
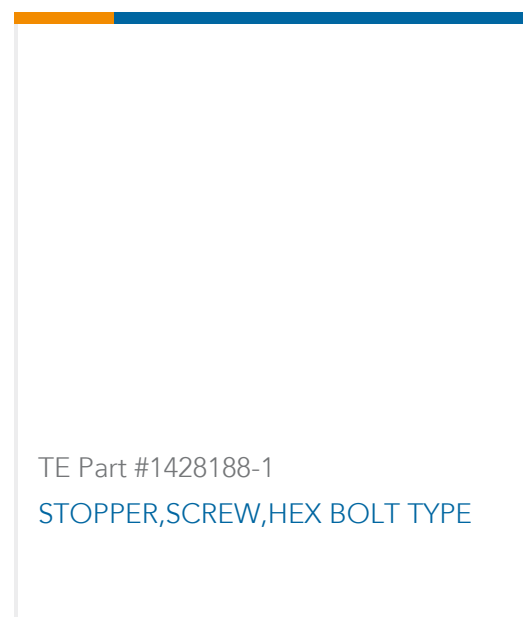
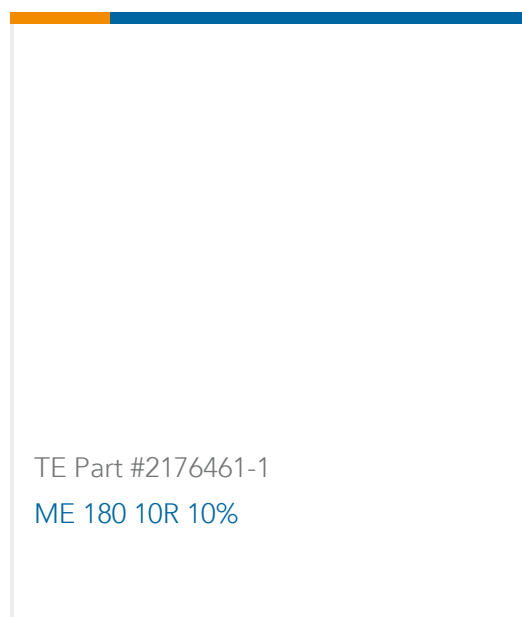
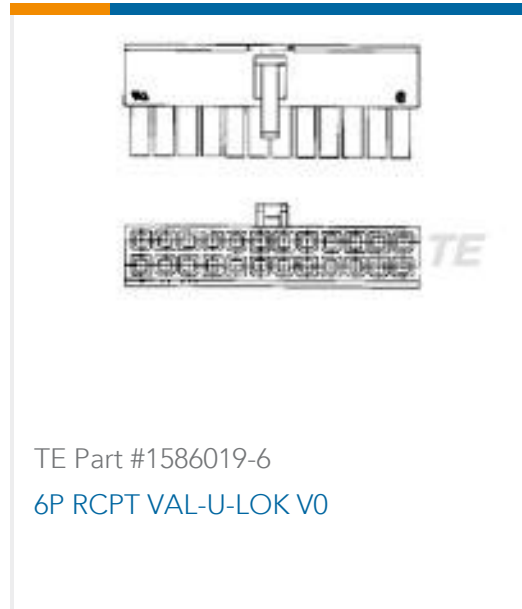

Documents

Product Drawings

8P PM PLUG VAL-U-LOK V0

English

CAD Files

Customer View Model

[ENG_CVM_1586018-8_A.3d_igs.zip](#)

English

Customer View Model

[ENG_CVM_1586018-8_A.3d_stp.zip](#)

English

Customer View Model

[ENG_CVM_1586018-8_A.2d_dxf.zip](#)

English

3D PDF

English

By downloading the CAD file I accept and agree to the [Terms and Conditions](#) of use.



Datasheets & Catalog Pages

[SOFT_SHELL_PIN_AND_SOCKET_CONNECTORS_CATALOG](#)

English

Product Specifications

[Product Specification](#)

English

Agency Approvals

[UL Report](#)

English