

MT SEALED SERIES

(Ex-090 sealed connector)

Features

The MT sealed connector series, developed for connecting waterproof wiring, has 5 mm and 6 mm pitches between terminal poles.

This series consists of a 090 type classified according to terminal size, supporting use in a variety of control circuits and low power circuits.

- Perfect performance is ensured even when used in an automobile engine compartment.
- A model that can be directly secured to a bracket on the car body is also available.

Structure

D-02

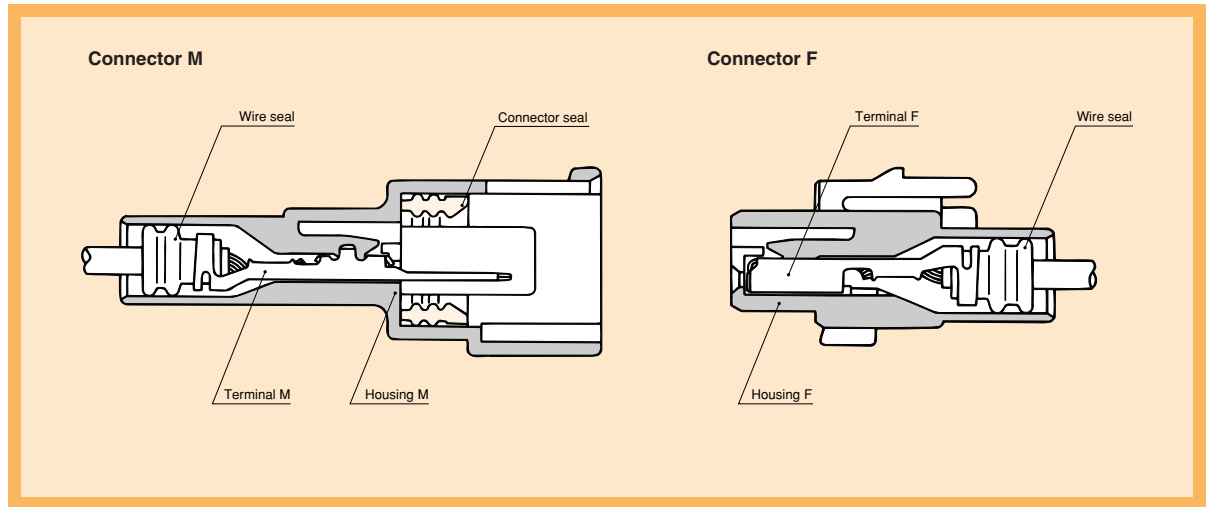

Terminal (UNIT: mm)

Cable size (mm ²)	0.3~1.25
Cable overall diameter (mm)	1.4~2.9
Material	Brass
Surface treatment	Tin-plated
Reel (piece)	5000
Thickness (mm)	0.3 (Tab thickness : 0.64)

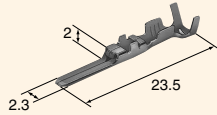

M(1500-0105)

Cable size (mm ²)	0.3~1.25
Cable overall diameter (mm)	1.4~2.9
Material	Heat-resistant copper alloy
Surface treatment	Tin-plated
Reel (piece)	5000
Thickness (mm)	0.25

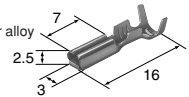

F(1500-0110)

Cable size (mm ²)	2.0
Cable overall diameter (mm)	2.0~2.7
Material	Brass
Surface treatment	Tin-plated
Reel (piece)	5000
Thickness (mm)	0.3 (Tab thickness : 0.64)

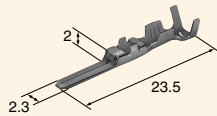

M(8230-4408)

Cable size (mm ²)	2.0
Cable overall diameter (mm)	2.0~2.7
Material	Heat-resistant copper alloy
Surface treatment	Tin-plated
Reel (piece)	5000
Thickness (mm)	0.25

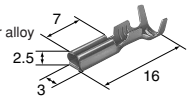

F(8240-4828)

Wire seals (UNIT: mm)

- The wire seals are common to M and F.
- P5: For 5mm Pitch housing/Please inquire us for the details.
- P6: For 6mm pitch housing

Cable overall diameter (mm)	2.0~2.7
Material	N.B.R.
Color	Brown

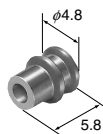

For P5 **(7161-9785)**

Cable overall diameter (mm)	2.0~2.7
Material	N.B.R.
Color	Black

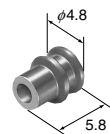

For P5 **(7160-9785)**

MT SEALED SERIES

090(2.3 mm) / STANDARD

D-03

090

Cable overall diameter (mm)	1.7~2.7
Material	N.B.R.
Color	Black

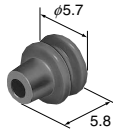

For P6 (7160-8234)

Cable overall diameter (mm)	1.3~1.7
Material	N.B.R.
Color	Green



For fine cables (7165-0076)

Dummy plugs (UNIT: mm)

- Dummy plugs are common to M and F.
- Dummy plugs are used to blind unused terminal holes.
- P5: For 5mm Pitch housing/Please inquire us for the details.
- P6: For 6mm pitch housing

090

Material	N.B.R.
Color	Brown

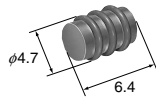

For P5 (7161-9787)

Material	N.B.R.
Color	Black

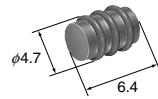

For P5 (7160-9787)

Material	N.B.R.
Color	Black

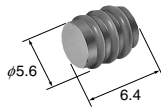

For P6 (7160-9465)

Housing (UNIT: mm)

Material / P.B.T.
Color / Natural

1way

Ref: Terminal part No.	D-02
Ref: Wire seal No.	D-03 (For P6)
Ref: Dummy plug No.	D-03 (For P6)

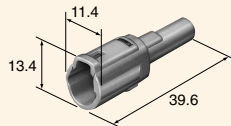

M(6187-1171)

Ref: Terminal part No.	D-02
Ref: Wire seal No.	D-03 (For P6)
Ref: Dummy plug No.	D-03 (For P6)

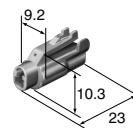

F(6180-1181)

Ref: Terminal part No.	D-02
Ref: Wire seal No.	D-03 (For P6)
Ref: Dummy plug No.	D-03 (For P6)
Note	

With clamp for 7mm dia.

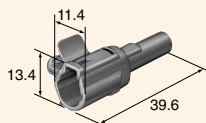

Plate thickness range for clamp :
t=0.7~2.2 M(6187-1561)

MT SEALED SERIES

090(2.3 mm) / STANDARD

D-04

2way
(AL Type)

Ref: Terminal part No. D-02
 Ref: Wire seal No. D-03 (For P6)
 Ref: Dummy plug No. D-03 (For P6)

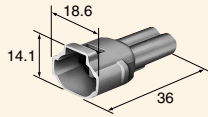

M(6187-2171)

Ref: Terminal part No. D-02
 Ref: Wire seal No. D-03 (For P6)
 Ref: Dummy plug No. D-03 (For P6)

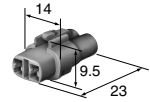

F(6180-2181)

2way
(IL Type)

Ref: Terminal part No. D-02
 Ref: Wire seal No. D-03 (For P6)
 Ref: Dummy plug No. D-03 (For P6)

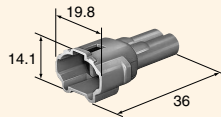

M(6187-2311)

Ref: Terminal part No. D-02
 Ref: Wire seal No. D-03 (For P6)
 Ref: Dummy plug No. D-03 (For P6)

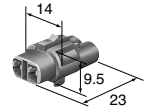

F(6180-2321)

3way
(E Type)

Ref: Terminal part No. D-02
 Ref: Wire seal No. D-03 (For P6)
 Ref: Dummy plug No. D-03 (For P6)
 Note
 With clamp for 7mm dia.

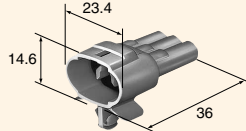

M(6187-3281)

Ref: Terminal part No. D-02
 Ref: Wire seal No. D-03 (For P6)
 Ref: Dummy plug No. D-03 (For P6)

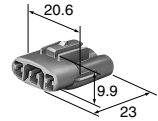

F(6180-3261)

Plate thickness range for clamp :
 $t=0.7\sim 2.2$

3way
(T Type)

Ref: Terminal part No. D-02
 Ref: Wire seal No. D-03 (For P6)
 Ref: Dummy plug No. D-03 (For P6)

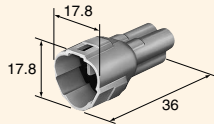

M(6187-3231)

Ref: Terminal part No. D-02
 Ref: Wire seal No. D-03 (For P6)
 Ref: Dummy plug No. D-03 (For P6)
 Note
 With clamp for 7mm dia.

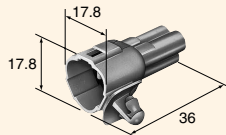

M(6187-3271)

Plate thickness range for clamp :
 $t=0.7\sim 2.2$

Ref: Terminal part No. D-02
 Ref: Wire seal No. D-03 (For P6)
 Ref: Dummy plug No. D-03 (For P6)

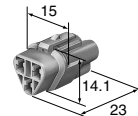

F(6180-3241)

Ref: Terminal part No. D-02
 Ref: Wire seal No. D-03 (For P6)
 Ref: Dummy plug No. D-03 (For P6)
 Note
 With unrotate clamp.

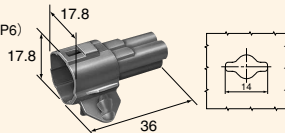

M(6188-0018)

Plate thickness range for clamp :
 $t=0.7\sim 2.2$

MT SEALED SERIES

090(2.3 mm) / STANDARD

D-05

Ref: Terminal part No. D-02
 Ref: Wire seal No. D-03 (For P6)
 Ref: Dummy plug No. D-03 (For P6)

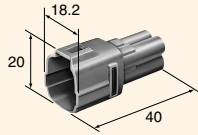

M(6188-0004)

4way

Ref: Terminal part No. D-02
 Ref: Wire seal No. D-03 (For P6)
 Ref: Dummy plug No. D-03 (For P6)
Note

With clamp for 7mm dia.

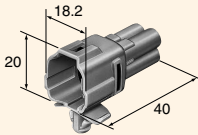
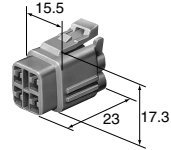

Plate thickness range for clamp :
 $t=0.7\sim 2.2$

M(6187-4561)

Ref: Terminal part No. D-02
 Ref: Wire seal No. D-03 (For P6)
 Ref: Dummy plug No. D-03 (For P6)



F(6180-4771)

6way

Ref: Terminal part No. D-02
 Ref: Wire seal No. D-03 (For P6)
 Ref: Dummy plug No. D-03 (For P6)
Note

With clamp for 7mm dia.

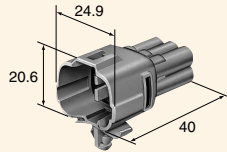
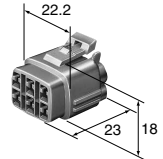

Plate thickness range for clamp :
 $t=0.7\sim 2.2$

M(6187-6561)

Ref: Terminal part No. D-02
 Ref: Wire seal No. D-03 (For P6)
 Ref: Dummy plug No. D-03 (For P6)



F(6180-6771)

Structure

D-06

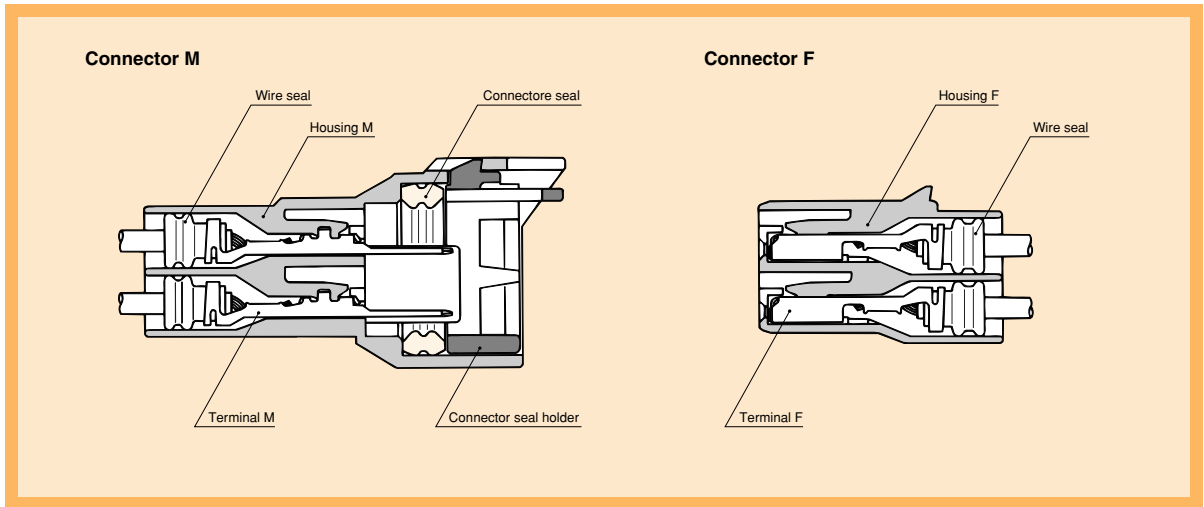

Housing (UNIT: mm)

Material / 66 Nylon
Color / Natural

4way	<table border="1"> <tr><td>Ref: Terminal part No.</td><td>D-02</td></tr> <tr><td>Ref: Wire seal No.</td><td>D-03 (For P6)</td></tr> <tr><td>Ref: Dummy plug No.</td><td>D-03 (For P6)</td></tr> </table> <p>M(6189-4171)</p>	Ref: Terminal part No.	D-02	Ref: Wire seal No.	D-03 (For P6)	Ref: Dummy plug No.	D-03 (For P6)	<table border="1"> <tr><td>Ref: Terminal part No.</td><td>D-02</td></tr> <tr><td>Ref: Wire seal No.</td><td>D-03 (For P6)</td></tr> <tr><td>Ref: Dummy plug No.</td><td>D-03 (For P6)</td></tr> </table> <p>F(6180-4181)</p>	Ref: Terminal part No.	D-02	Ref: Wire seal No.	D-03 (For P6)	Ref: Dummy plug No.	D-03 (For P6)
	Ref: Terminal part No.	D-02												
Ref: Wire seal No.	D-03 (For P6)													
Ref: Dummy plug No.	D-03 (For P6)													
Ref: Terminal part No.	D-02													
Ref: Wire seal No.	D-03 (For P6)													
Ref: Dummy plug No.	D-03 (For P6)													
6way	<table border="1"> <tr><td>Ref: Terminal part No.</td><td>D-02</td></tr> <tr><td>Ref: Wire seal No.</td><td>D-03 (For P6)</td></tr> <tr><td>Ref: Dummy plug No.</td><td>D-03 (For P6)</td></tr> </table> <p>M(6189-6171)</p>	Ref: Terminal part No.	D-02	Ref: Wire seal No.	D-03 (For P6)	Ref: Dummy plug No.	D-03 (For P6)	<table border="1"> <tr><td>Ref: Terminal part No.</td><td>D-02</td></tr> <tr><td>Ref: Wire seal No.</td><td>D-03 (For P6)</td></tr> <tr><td>Ref: Dummy plug No.</td><td>D-03 (For P6)</td></tr> </table> <p>F(6180-6181)</p>	Ref: Terminal part No.	D-02	Ref: Wire seal No.	D-03 (For P6)	Ref: Dummy plug No.	D-03 (For P6)
Ref: Terminal part No.	D-02													
Ref: Wire seal No.	D-03 (For P6)													
Ref: Dummy plug No.	D-03 (For P6)													
Ref: Terminal part No.	D-02													
Ref: Wire seal No.	D-03 (For P6)													
Ref: Dummy plug No.	D-03 (For P6)													

Structure

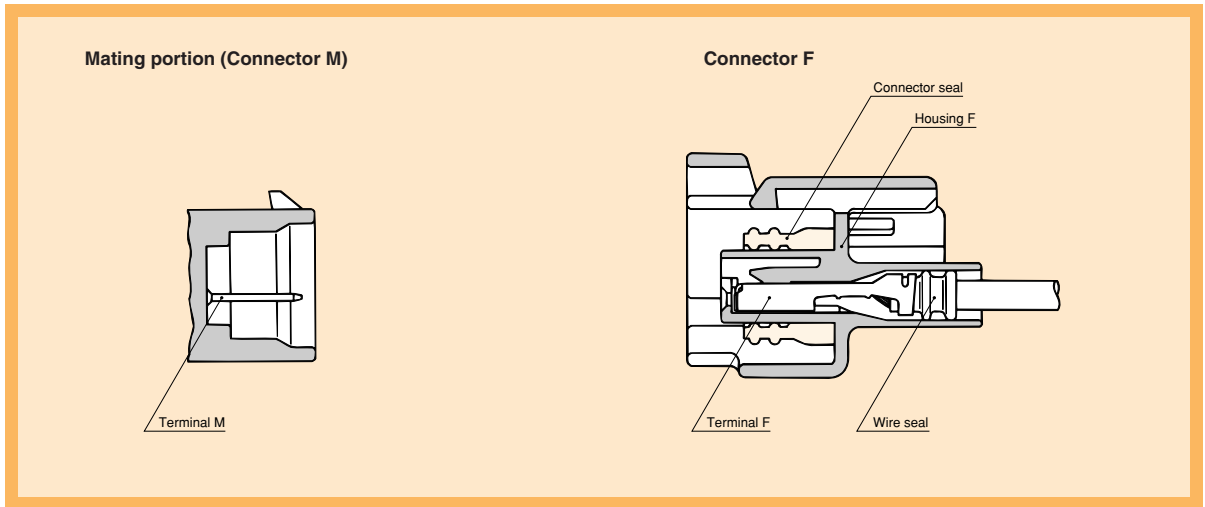

Housing (UNIT: mm)

Material / P.B.T.

2way

Ref: Terminal part No.	D-02
Ref: Wire seal No.	D-02 (For P5)
Ref: Dummy plug No.	D-03 (For P5)
Color	Gray



F(6189-0035)

Ref: Terminal part No.	D-02
Ref: Wire seal No.	D-02 (For P5)
Ref: Dummy plug No.	D-03 (For P5)
Color	Gray

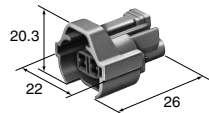

F(6189-0039)

Ref: Terminal part No.	D-02
Ref: Wire seal No.	D-02 (For P5)
Ref: Dummy plug No.	D-03 (For P5)
Color	Gray

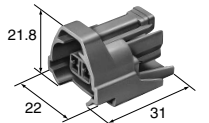

F(6189-0056)

Ref: Terminal part No.	D-02
Ref: Wire seal No.	D-02 (For P5)
Ref: Dummy plug No.	D-03 (For P5)
Color	Gray

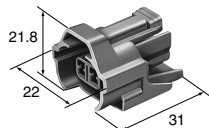

F(6189-0060)

MT SEALED SERIES

090(2.3 mm) / STANDARD

D-08

Ref: Terminal part No.	D-02
Ref: Wire seal No.	D-03 (For P6)
Ref: Dummy plug No.	D-03 (For P6)
Color	Blue

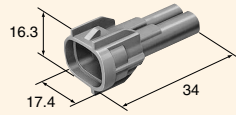

M(6180-2405)

Ref: Terminal part No.	D-02
Ref: Wire seal No.	D-03 (For P6)
Ref: Dummy plug No.	D-03 (For P6)
Color	Blue

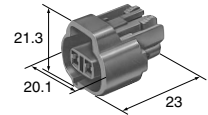

F(6189-0031)

2way

Ref: Terminal part No.	D-02
Ref: Wire seal No.	D-03 (For P6)
Ref: Dummy plug No.	D-03 (For P6)
Color	Brown

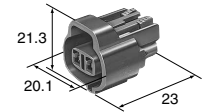

F(6189-0033)

Ref: Terminal part No.	D-02
Ref: Wire seal No.	D-03 (For P6)
Ref: Dummy plug No.	D-03 (For P6)
Color	Natural

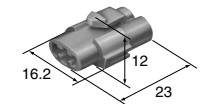

F(6180-2191)

3way

Ref: Terminal part No.	D-02
Ref: Wire seal No.	D-03 (For P6)
Ref: Dummy plug No.	D-03 (For P6)
Color	Gray

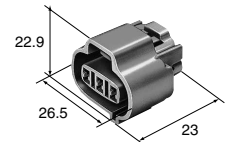

F(6189-0027)

Ref: Terminal part No.	D-02
Ref: Wire seal No.	D-03 (For P6)
Ref: Dummy plug No.	D-03 (For P6)
Color	Gray

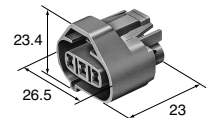

F(6189-0028)

6way

Ref: Terminal part No.	D-02
Ref: Wire seal No.	D-03 (For P6)
Ref: Dummy plug No.	D-03 (For P6)
Color	Gray

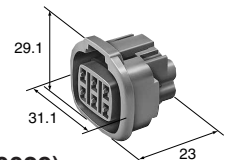

F(6189-0029)

Structure

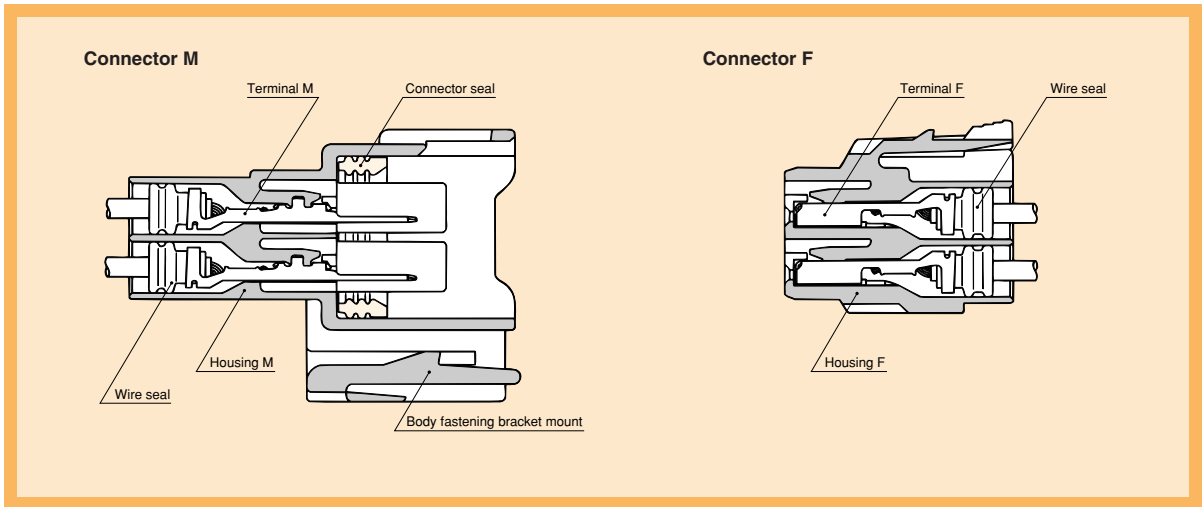

Housing (UNIT: mm)

Material / P.B.T.

2way

Ref: Terminal part No.	D-02
Ref: Wire seal No.	D-03 (For P6)
Ref: Dummy plug No.	D-03 (For P6)
Color	Natural
Note	

Bracket for attaching

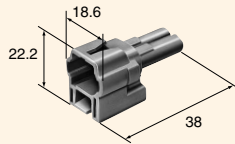

M(6187-2581)

Ref: Terminal part No.	D-02
Ref: Wire seal No.	D-03 (For P6)
Ref: Dummy plug No.	D-03 (For P6)
Color	Natural

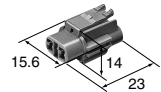

F(6180-2591)

2way
(Special shape)

Ref: Terminal part No.	D-02
Ref: Wire seal No.	D-03 (For P6)
Ref: Dummy plug No.	D-03 (For P6)
Color	Gray
Note	

Bracket for attaching

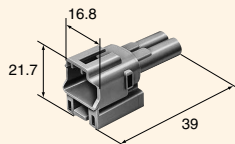

M(6187-2607)

Ref: Terminal part No.	D-02
Ref: Wire seal No.	D-03 (For P6)
Ref: Dummy plug No.	D-03 (For P6)
Color	Gray

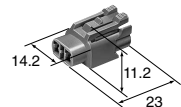

F(6180-2617)

3way

Ref: Terminal part No.	D-02
Ref: Wire seal No.	D-03 (For P6)
Ref: Dummy plug No.	D-03 (For P6)
Color	Natural
Note	

Bracket for attaching

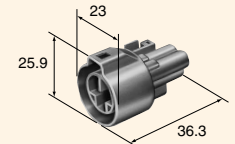

M(6180-3891)

Ref: Terminal part No.	D-02
Ref: Wire seal No.	D-03 (For P6)
Ref: Dummy plug No.	D-03 (For P6)
Color	Natural

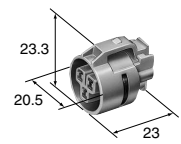

F(6187-3901)

4way

Ref: Terminal part No.	D-02
Ref: Wire seal No.	D-03 (For P6)
Ref: Dummy plug No.	D-03 (For P6)
Color	Green
Note	

Bracket for attaching

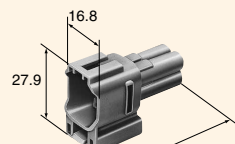

M(6187-4583)

Ref: Terminal part No.	D-02
Ref: Wire seal No.	D-03 (For P6)
Ref: Dummy plug No.	D-03 (For P6)
Color	Green

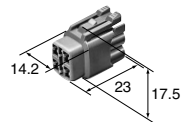

F(6180-4593)

MT SEALED SERIES

090(2.3 mm) / ATTACHING TYPE

D-10

6way

Ref: Terminal part No.	D-02
Ref: Wire seal No.	D-03 (For P6)
Ref: Dummy plug No.	D-03 (For P6)
Color	Natural
Note	

Bracket for attaching

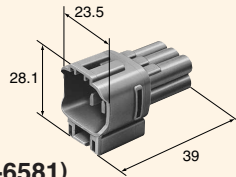

M(6187-6581)

Ref: Terminal part No.	D-02
Ref: Wire seal No.	D-03 (For P6)
Ref: Dummy plug No.	D-03 (For P6)
Color	Natural

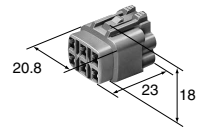

F(6180-6591)

▶▶ Bracket for attaching (UNIT: mm) ◀◀

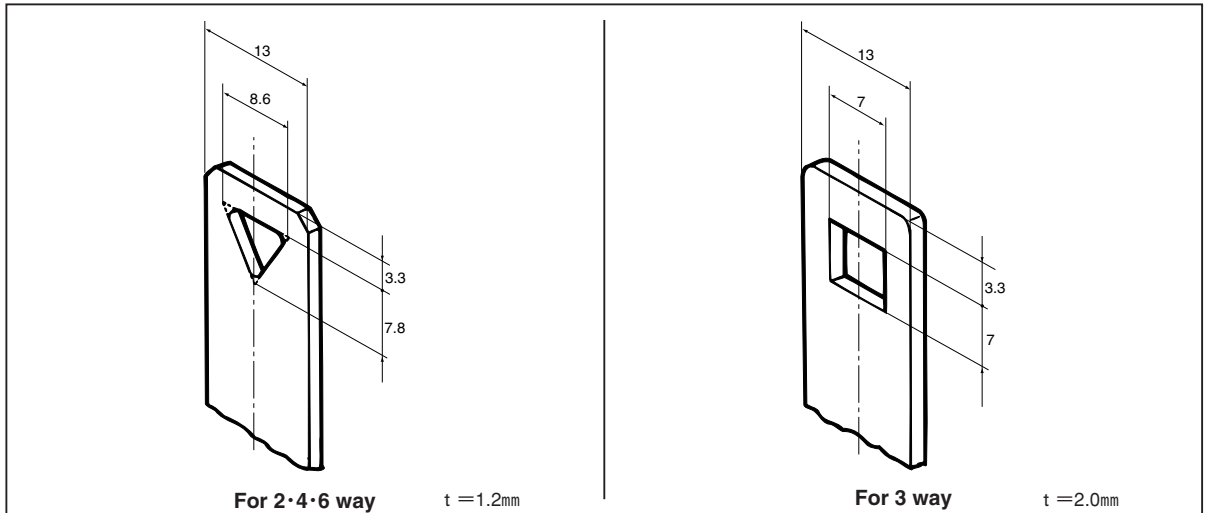

Note) The dimensions as shown here are reference dimensions and detail dimensions for mounting portion of the bracket are specified in the official drawing. Please contact our sales staff.