



MATE-N-LOK | Commercial MATE-N-LOK

TE Internal #: 163301-8

Power Contacts, Contact, Pre-Tin, 20 – 17 AWG Wire Size, .5 – 1 mm² Wire Size, Wire-to-Wire, Wire & Cable, Crimp, Power, Pin, Commercial MATE-N-LOK

[View on TE.com >](#)

Connectors > Power Connectors > Power Contacts

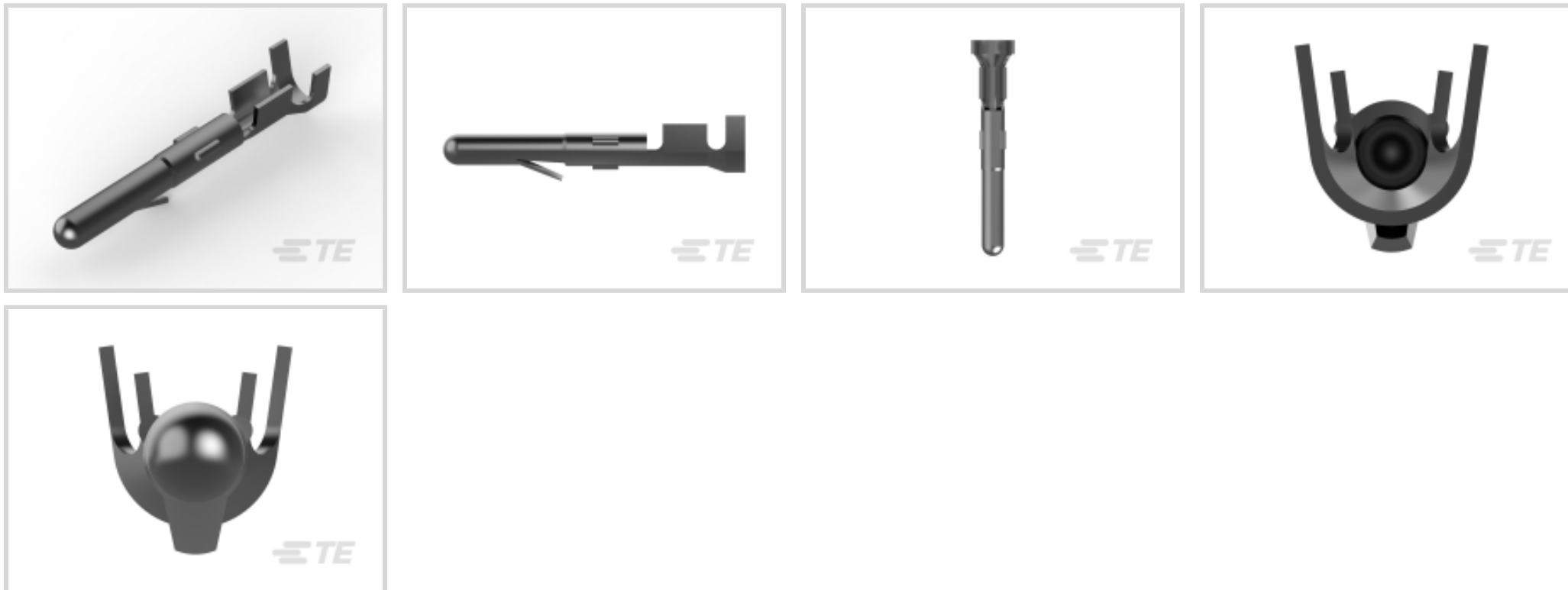

Power Contact Type: **Contact**

Contact Mating Area Plating Material: **Pre-Tin**

Wire Size: **.5 – 1 mm²**

Connector System: **Wire-to-Wire**

Features

Product Type Features

Power Contact Type	Contact
Connector System	Wire-to-Wire
Connector & Contact Terminates To	Wire & Cable

Contact Features

Contact Shape & Form	Round
Contact Mating Area Plating Material	Pre-Tin
Contact Type	Pin
Contact Retention Within Housing	With
Mating Pin Diameter	2.1 mm[.082 in]
Contact Base Material	Phosphor Bronze
Wire Contact Termination Area Plating Material	Tin-Lead
Wire Contact Termination Area Plating Material Finish	Bright
Contact Orientation	Straight
Barrel Type	Open Barrel

Termination Features



Termination Method to Wire & Cable	Crimp
------------------------------------	-------

Mechanical Attachment

Contact Retention Type Within Housing	Locking Lance
Connector Mounting Type	Cable Mount (Free-Hanging)
Wire Insulation Support	Without

Dimensions

Wire Size	.5 – 1 mm ²
Accepts Wire Insulation Diameter Range	1.8 – 3.3 mm [.071 – .13 in]

Usage Conditions

Operating Temperature Range	-55 – 105 °C
-----------------------------	--------------

Operation/Application

Circuit Application	Power
---------------------	-------

Industry Standards

Glow Wire Rating	Standard Part - Not Glow Wire
VDE Tested	No

Packaging Features

Packaging Method	Reel
Packaging Quantity	4500

Other

Wire/Cable Type	Discrete Wire
Wire Type	Stranded
For Use With	Pin (Cap) Housing

Product Compliance

[For compliance documentation, visit the product page on TE.com>](#)

EU RoHS Directive 2011/65/EU	Compliant
EU ELV Directive 2000/53/EC	Compliant
China RoHS 2 Directive MIIT Order No 32, 2016	No Restricted Materials Above Threshold
EU REACH Regulation (EC) No. 1907/2006	Current ECHA Candidate List: JUNE 2022 (224) Candidate List Declared Against: JAN 2022 (223) SVHC > Threshold:

Not Yet Reviewed

Halogen Content

Low Halogen - Br, Cl, F, I < 900 ppm per homogenous material. Also BFR/CFR/PVC Free

Solder Process Capability

Not applicable for solder process capability

Product Compliance Disclaimer

This information is provided based on reasonable inquiry of our suppliers and represents our current actual knowledge based on the information they provided. This information is subject to change. The part numbers that TE has identified as EU RoHS compliant have a maximum concentration of 0.1% by weight in homogenous materials for lead, hexavalent chromium, mercury, PBB, PBDE, DBP, BBP, DEHP, DIBP, and 0.01% for cadmium, or qualify for an exemption to these limits as defined in the Annexes of Directive 2011/65/EU (RoHS2). Finished electrical and electronic equipment products will be CE marked as required by Directive 2011/65/EU. Components may not be CE marked. Additionally, the part numbers that TE has identified as EU ELV compliant have a maximum concentration of 0.1% by weight in homogenous materials for lead, hexavalent chromium, and mercury, and 0.01% for cadmium, or qualify for an exemption to these limits as defined in the Annexes of Directive 2000/53/EC (ELV). Regarding the REACH Regulation, the information TE provides on SVHC in articles for this part number is based on the latest European Chemicals Agency (ECHA) 'Guidance on requirements for substances in articles' posted at this URL: <https://echa.europa.eu/guidance-documents/guidance-on-reach>

Compatible Parts



TE Part # 465644-1
EXTRACTION TOOL



TE Part # 455830-1
INSERTION TOOL



TE Part # 1-171196-0
6 POS MATE-N-LOK S



TE Part # 1-480274-0
09P CMNL PLUG HSG P/M NATL



TE Part # 1-480284-0
08P CMNL CAP HSG M/M NATL



TE Part # 1-480438-0
16P CMNL PLUG HSG M/M NATL



TE Part # 1-480683-0
02P CMNL PLUG HSG F/H NATL



TE Part # 1-480277-0
09P CMNL CAP HSG P/M NATL



TE Part # 1-480304-0
03P CMNL PLUG HSG P/M NATL



TE Part # 1-480722-0
04P CMNL PLUG HSG W/LCK NATL



TE Part # 1-480276-0
06P CMNL CAP HSG P/M NATL



TE Part # 1-480285-0
10P CMNL PLUG HSG M/M NATL



Also in the Series | Commercial MATE-N-LOK

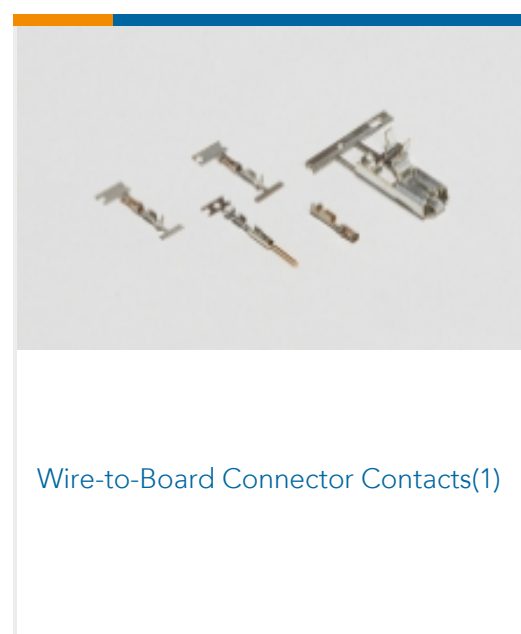
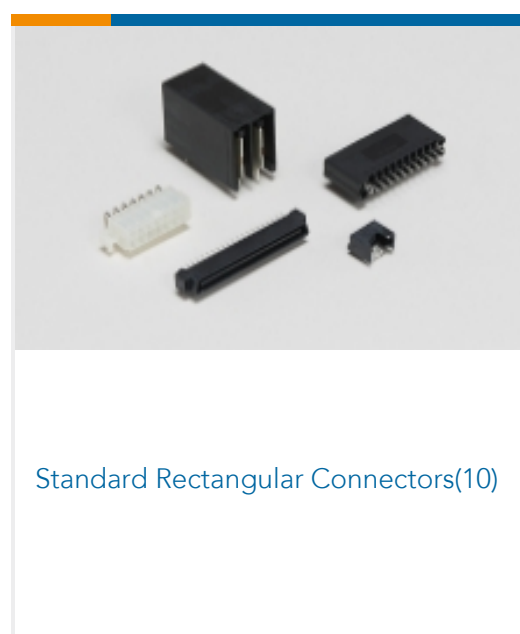
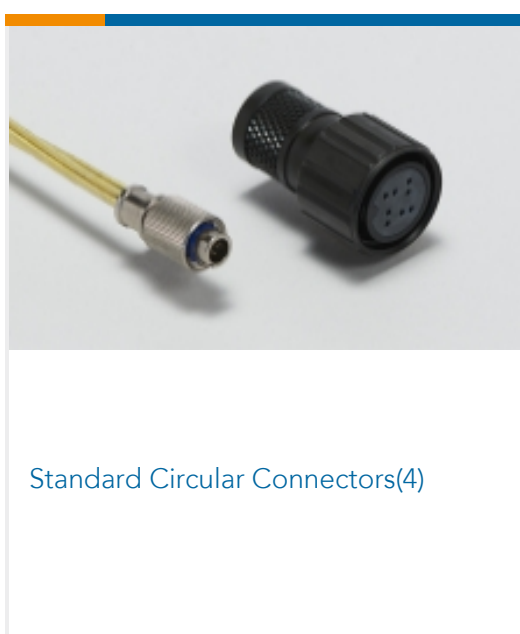
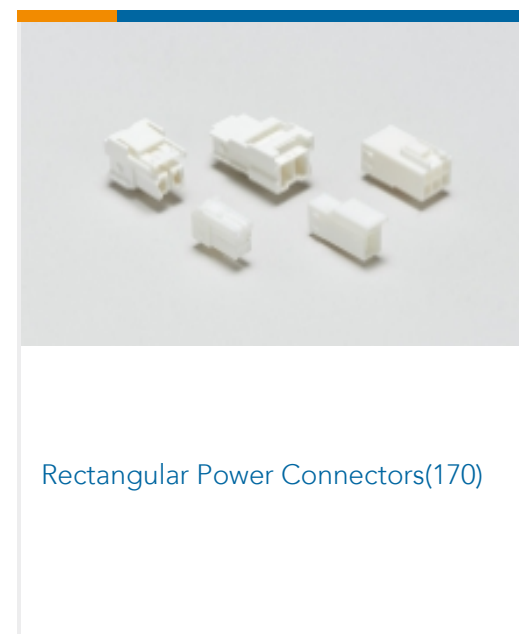
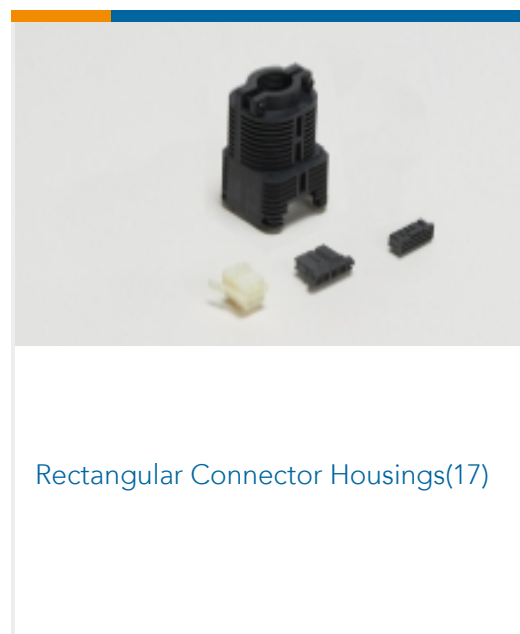
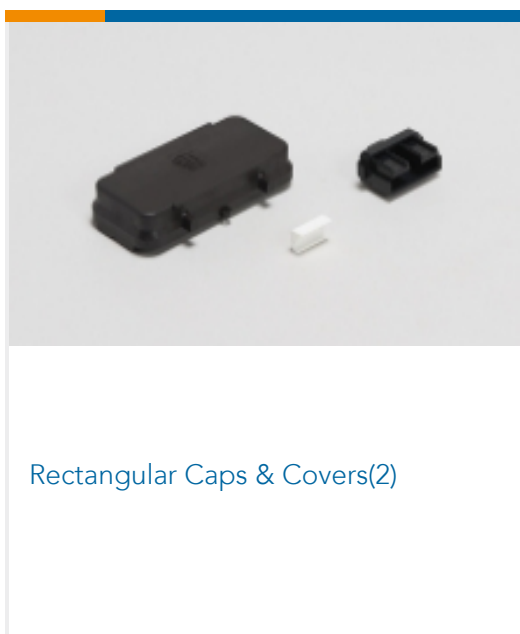
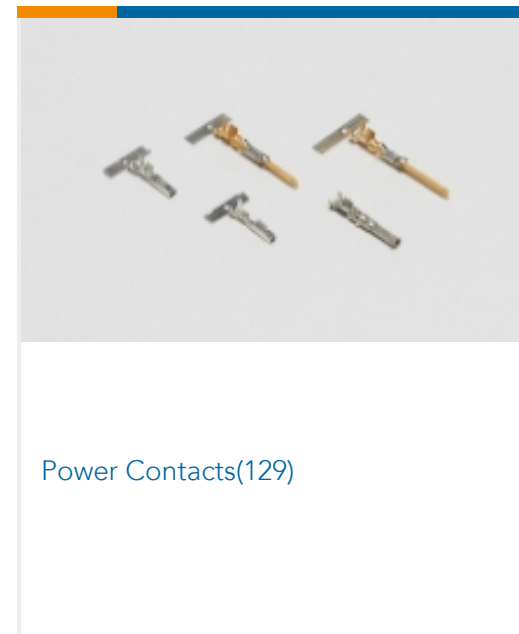
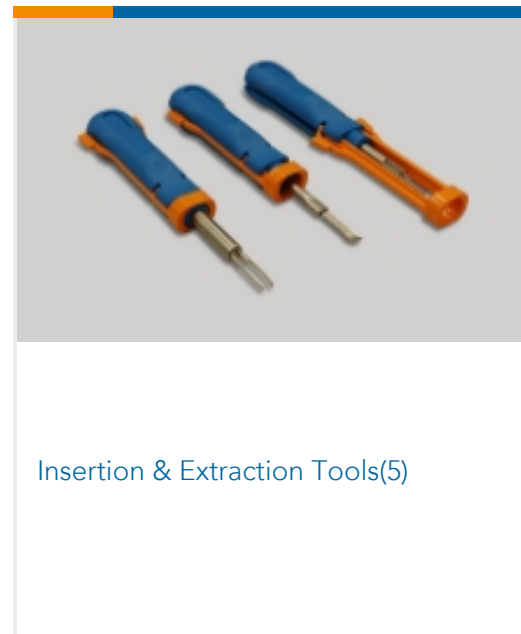
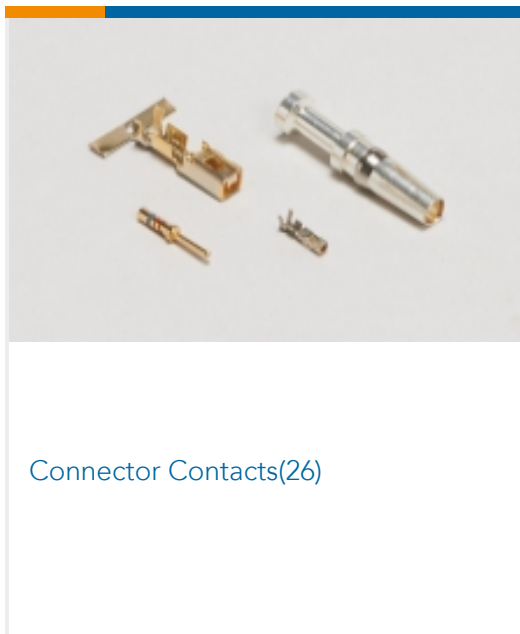

Customers Also Bought

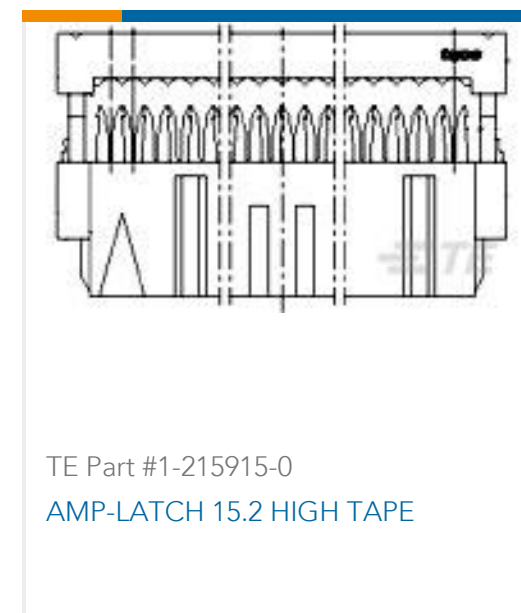

Documents

Product Drawings

MATENLOK PIN

English

CAD Files

3D PDF

English

Customer View Model

[ENG_CVM_163301-8_K.3d_igs.zip](#)

English

Customer View Model

[ENG_CVM_163301-8_K.3d_stp.zip](#)

English

Customer View Model

[ENG_CVM_163301-8_K.2d_dxf.zip](#)

English

By downloading the CAD file I accept and agree to the [Terms and Conditions](#) of use.