

1658528-5 ✓ ACTIVE



AMP-LATCH

TE Internal #: 1658528-5

Ribbon Cable Connectors, Wire-to-Board, 26 Position, .1 in [2.54 mm] Centerline, Insulation Displacement (IDC), 2 Row, Receptacle

[View on TE.com >](#)

Connectors > PCB Connectors > Wire-to-Board Connectors > FFC, FPC & Ribbon Connectors > Ribbon Cable Connectors

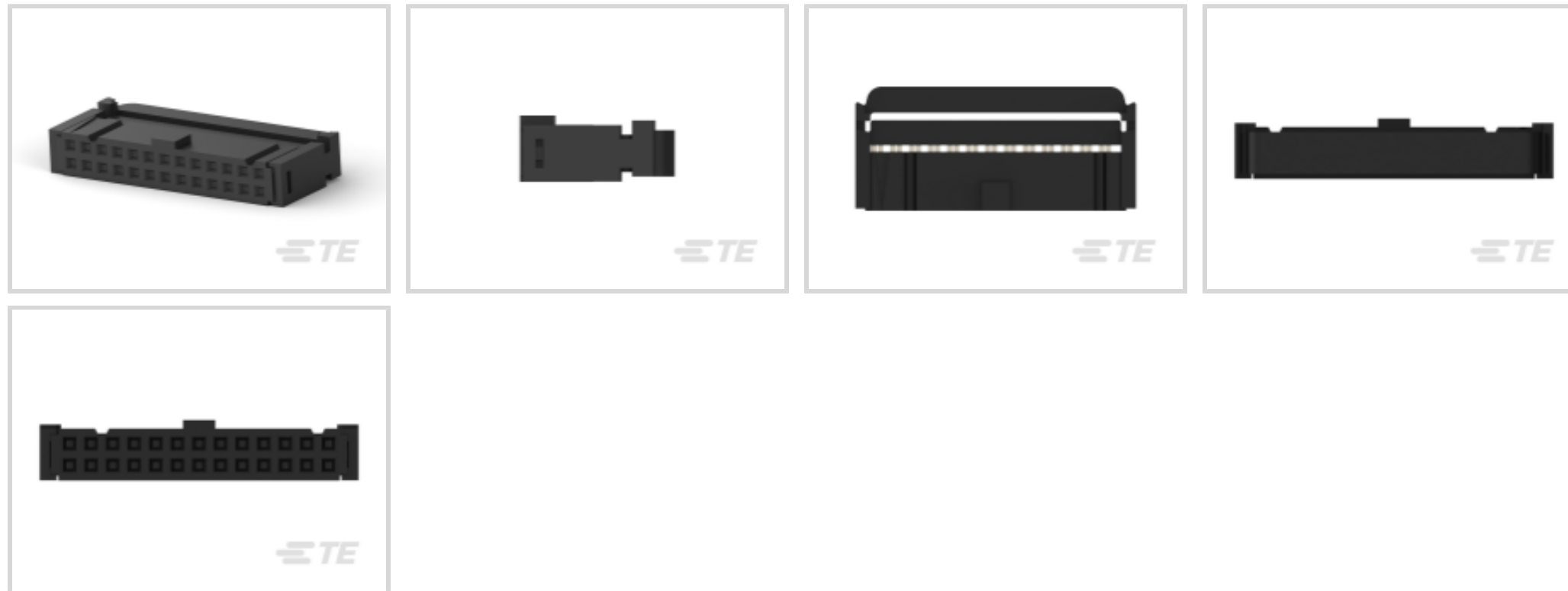

Connector System: **Wire-to-Board**

Number of Positions: **26**

Centerline (Pitch): **2.54 mm [.1 in]**

Termination Method to Wire & Cable: **Insulation Displacement (IDC)**

Row-to-Row Spacing: **2.54 mm [.1 in]**

Features

Product Type Features

Connector Product Type	Connector Assembly
Connector System	Wire-to-Board
Connector & Housing Type	Receptacle
Connector & Contact Terminates To	Wire & Cable

Configuration Features

Compatible With Wire & Cable Type	Ribbon Cable
Number of Positions	26
Number of Rows	2

Contact Features

Mating Square Post Dimension	.64 mm[.025 in]
Wire Contact Termination Area Plating Thickness	.127 μm[5 μin]
Wire Contact Termination Area Plating Material	Gold Flash
	15 μin
Contact Mating Area Plating Material	Gold



Contact Current Rating (Max)	1 A
------------------------------	-----

Termination Features

Termination Method to Wire & Cable	Insulation Displacement (IDC)
------------------------------------	-------------------------------

Mechanical Attachment

Mating Alignment Type	Polarization
-----------------------	--------------

Mating Retention	Without
------------------	---------

Connector Mounting Type	Cable Mount (Free-Hanging)
-------------------------	----------------------------

Housing Features

Housing Color	Black
---------------	-------

Centerline (Pitch)	2.54 mm[.1 in]
--------------------	----------------

Dimensions

Row-to-Row Spacing	2.54 mm[.1 in]
--------------------	----------------

Usage Conditions

Operating Temperature Range	-55 – 125 °C[-67 – 257 °F]
-----------------------------	----------------------------

Operation/Application

Circuit Application	Signal
---------------------	--------

Product Compliance

[For compliance documentation, visit the product page on TE.com>](#)

EU RoHS Directive 2011/65/EU	Compliant
------------------------------	-----------

EU ELV Directive 2000/53/EC	Compliant
-----------------------------	-----------

China RoHS 2 Directive MIIT Order No 32, 2016	No Restricted Materials Above Threshold
---	---

EU REACH Regulation (EC) No. 1907/2006	Current ECHA Candidate List: JUNE 2022 (224) Candidate List Declared Against: JAN 2022 (223) SVHC > Threshold: Not Yet Reviewed
--	--

Halogen Content	Not Low Halogen - contains Br or Cl > 900 ppm.
-----------------	--

Solder Process Capability	Not applicable for solder process capability
---------------------------	--

Product Compliance Disclaimer

This information is provided based on reasonable inquiry of our suppliers and represents our current actual knowledge based on the information they provided. This information is subject to change. The part numbers that TE has identified as EU RoHS compliant have a maximum concentration of 0.1% by weight in homogenous materials for lead, hexavalent

chromium, mercury, PBB, PBDE, DBP, BBP, DEHP, DIBP, and 0.01% for cadmium, or qualify for an exemption to these limits as defined in the Annexes of Directive 2011/65/EU (RoHS2). Finished electrical and electronic equipment products will be CE marked as required by Directive 2011/65/EU. Components may not be CE marked. Additionally, the part numbers that TE has identified as EU ELV compliant have a maximum concentration of 0.1% by weight in homogenous materials for lead, hexavalent chromium, and mercury, and 0.01% for cadmium, or qualify for an exemption to these limits as defined in the Annexes of Directive 2000/53/EC (ELV). Regarding the REACH Regulation, the information TE provides on SVHC in articles for this part number is based on the latest European Chemicals Agency (ECHA) 'Guidance on requirements for substances in articles' posted at this URL: <https://echa.europa.eu/guidance-documents/guidance-on-reach>

Compatible Parts



TE Part # CAT-AM74-UN384H
AMP-LATCH UNIVERSAL HEADERS



TE Part # 1-111506-8
016 UNIV I/O 30DP SLOT LTCH



TE Part # 5103311-3
A/L LOW PRO HDR 16P RA BLACK



TE Part # 2-1761603-6
IDC LOW PRO HDR 16P VERT BLUE



TE Part # 5103310-3
A/L LOW PRO HDR 16P RA BLACK



TE Part # 5103309-3
A/L LOW PRO HDR 16P VERT BLACK



TE Part # 1761606-6
IDC LOW PRO HDR 16P VERT LG LAT BLK



TE Part # 2-1761606-6
IDC LOW PRO HDR 16P VERT LG LAT BLUE



TE Part # 5103308-3
A/L LOW PRO HDR 16P VERT BLACK



TE Part # 2-1761607-6
IDC LOW PRO HDR 16P RA LG LAT



TE Part # 1-111446-6
16 UNIV I/O, NO EARS, LEAD FREE



TE Part # 104128-3
016 LOPRO HDR SP 30DP LATCH



TE Part # 1761681-6
IDC LOW PRO HDR 16P VERT HT BLACK



TE Part # 2-1761679-6
IDC LOW PRO HDR 16P VERT BLUE



TE Part # 1761686-6
IDC LOW PRO HDR 16P VERT LG LAT



TE Part # 111293-1
UNIVERSAL HEADER LATCH

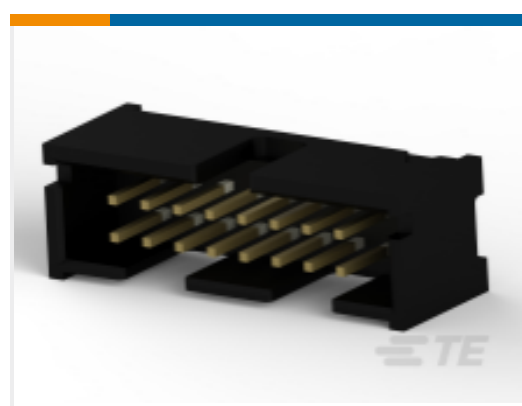

TE Part # 5104338-3
A/L LOW PRO HDR 16P VERT HT



TE Part # 1761607-6
IDC LOW PRO HDR 16P RA LG LAT
BLK

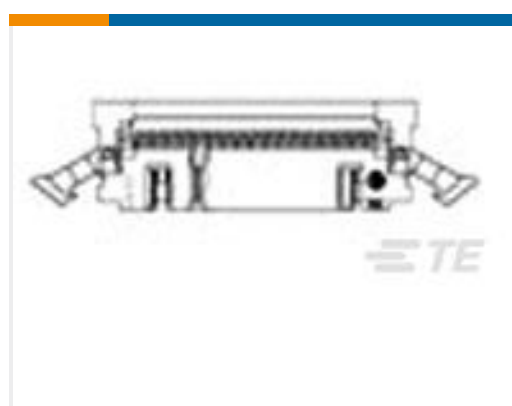

TE Part # 1-111504-6
016 UNIV I/O 30DP NO EARS LTCH

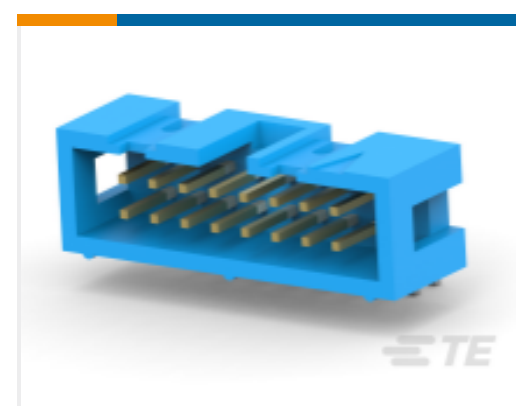

TE Part # 2-1761605-6
IDC LOW PRO HDR 16P RA BLUE

Customers Also Bought



TE Part #52942
PIDG SHORT SPRING SPADE
TONGUE TERMLS

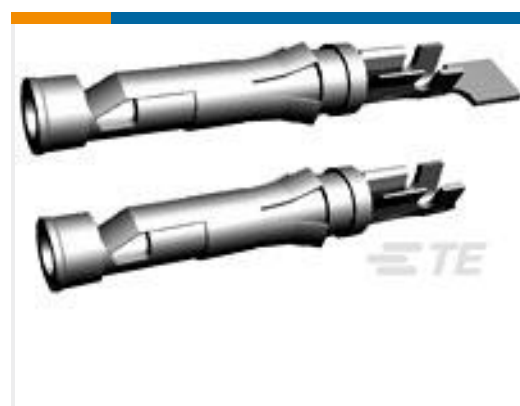

TE Part #66104-8
III+ SKT,24-20,15AU/FL,STRIP



TE Part #3-644043-6
06P MTA100 CONN ASSY LF



TE Part #3-1393127-8
PRD-11DG0-24=PRD



TE Part #2007198-1
SFP+ 1x1 Cage Assembly, Press-

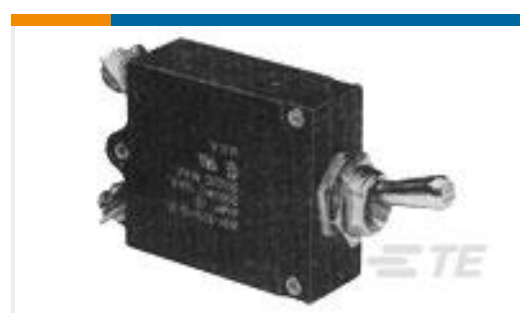

TE Part #3-1393247-8
W31-X2M1G-30=W23/W31

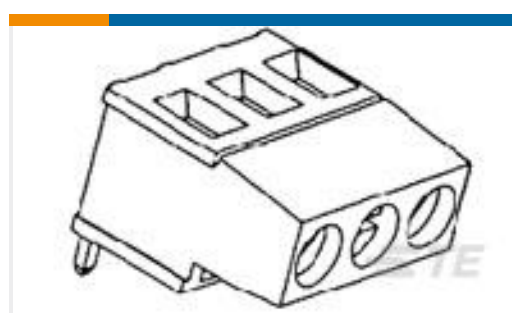

TE Part #1546073-9
9 POS 5.08MM TERMI-BLOK

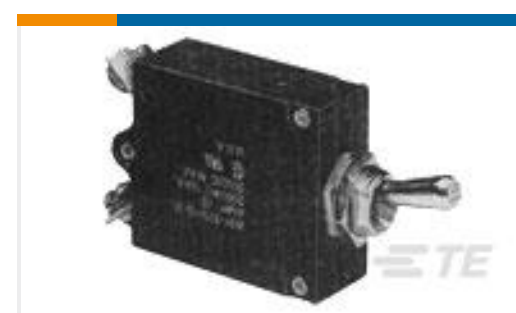

TE Part #3-1393247-6
W31-X2M1G-25=W23/W31



TE Part #1SNA115661R2100
M4/8.SFL

Documents

Product Drawings

[636-2641LF FEM SOCKT,LEAD FREE](#)

English

CAD Files

[3D PDF](#)

[3D](#)

[Customer View Model](#)

[ENG_CVM_CVM_1658528-5_D.2d_dxf.zip](#)



English

Customer View Model

[ENG_CVM_CVM_1658528-5_D.3d_igs.zip](#)

English

Customer View Model

[ENG_CVM_CVM_1658528-5_D.3d_stp.zip](#)

English

By downloading the CAD file I accept and agree to the [Terms and Conditions](#) of use.

Datasheets & Catalog Pages

[Ribbon Cable Interconnect Solutions](#)

English

Instruction Sheets

[Instruction Sheet \(U.S.\)](#)

English