

1586845-1 ✓ ACTIVE

MATE-N-LOK | Universal MATE-N-LOK

TE Internal #: 1586845-1

Rectangular Power Connectors, Housing, Receptacle, Wire-to-Panel / Wire-to-Wire, 4 Position, .25 in [6.35 mm] Centerline, Universal MATE-N-LOK

[View on TE.com >](#)



Connectors > Power Connectors > Rectangular Power > Rectangular Power Connectors

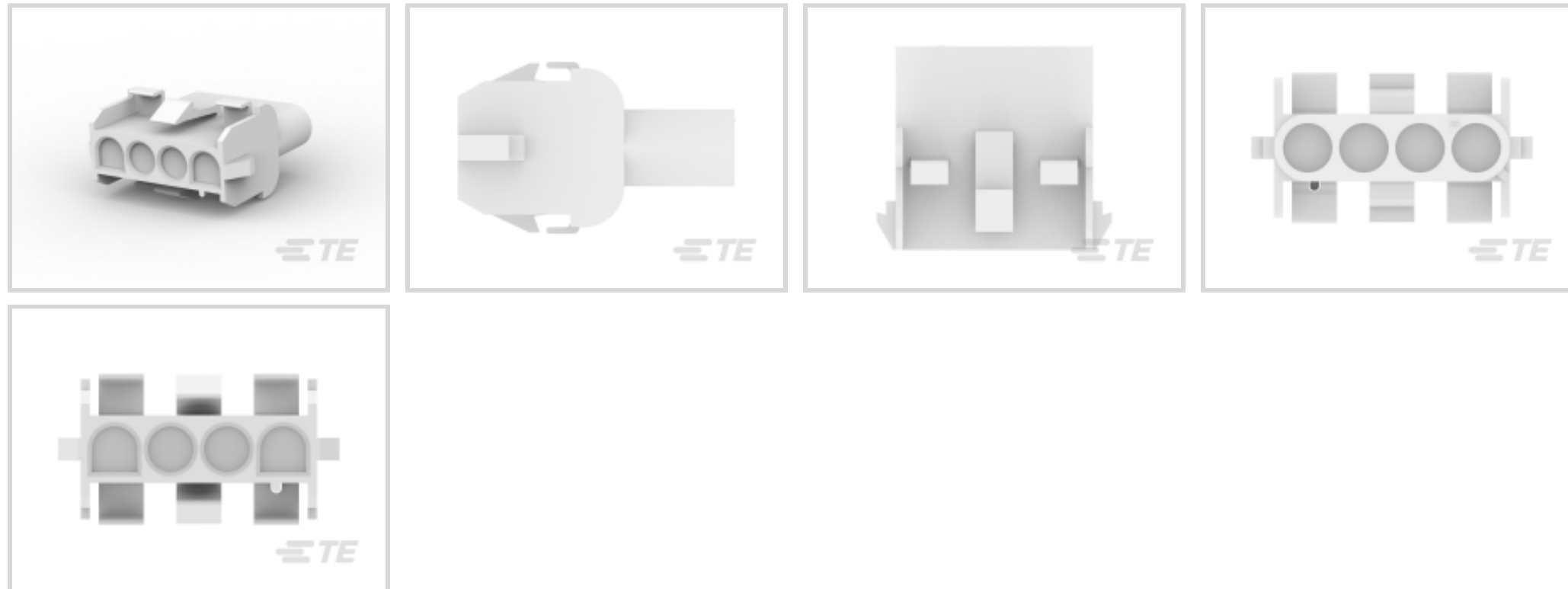

Rectangular Power Connector Type: **Housing**

Connector & Housing Type: **Receptacle**

Connector System: **Wire-to-Panel, Wire-to-Wire**

Number of Positions: **4**

Centerline (Pitch): **6.35 mm [.25 in]**

Features

Product Type Features

Rectangular Power Connector Type	Housing
Connector & Housing Type	Receptacle
Connector System	Wire-to-Panel, Wire-to-Wire
Sealable	No
Connector & Contact Terminates To	Wire & Cable

Configuration Features

Number of Positions	4
Number of Rows	1

Electrical Characteristics

Operating Voltage	600 VAC
-------------------	---------

Contact Features

Multiple Contact Types	Without
Contact Layout	Inline
Contact Retention Within Housing	Without



Contact Type	Pin
--------------	-----

Termination Features

Termination Method to Wire & Cable	Crimp
------------------------------------	-------

Mechanical Attachment

Panel Mount Feature	With
---------------------	------

Panel Mount Feature Type	Latches
--------------------------	---------

Connector Mounting Type	Panel Mount
-------------------------	-------------

Housing Features

Centerline (Pitch)	6.35 mm [.25 in]
--------------------	------------------

Housing Color	Natural
---------------	---------

Housing Material	Nylon
------------------	-------

Dimensions

Panel Thickness	.76 – 2.29 mm [.76 – 2.29 in]
-----------------	-------------------------------

Usage Conditions

Operating Temperature Range	-55 – 105 °C [-67 – 221 °F]
-----------------------------	-----------------------------

Operation/Application

Assembly Integration Feature	Without
------------------------------	---------

Circuit Application	Power & Signal
---------------------	----------------

Industry Standards

UL Flammability Rating	UL 94V-2
------------------------	----------

Glow Wire Rating	GWT 750°C (Without Flame)
------------------	---------------------------

UL Rating	Recognized
-----------	------------

Agency/Standard Number	E28476
------------------------	--------

VDE Tested	Yes
------------	-----

Agency/Standard	UL
-----------------	----

Packaging Features

Packaging Method	Package
------------------	---------

Packaging Quantity	1
--------------------	---

Other

For Use With	Appropriate Universal MATE-N-LOK Plug
--------------	---------------------------------------



Product Compliance

[For compliance documentation, visit the product page on TE.com>](#)

EU RoHS Directive 2011/65/EU	Compliant
EU ELV Directive 2000/53/EC	Compliant
China RoHS 2 Directive MIIT Order No 32, 2016	No Restricted Materials Above Threshold
EU REACH Regulation (EC) No. 1907/2006	Current ECHA Candidate List: JUNE 2022 (224) Candidate List Declared Against: JAN 2022 (223) SVHC > Threshold: Not Yet Reviewed
Halogen Content	Not Low Halogen - contains Br or Cl > 900 ppm.
Solder Process Capability	Not applicable for solder process capability

Product Compliance Disclaimer

This information is provided based on reasonable inquiry of our suppliers and represents our current actual knowledge based on the information they provided. This information is subject to change. The part numbers that TE has identified as EU RoHS compliant have a maximum concentration of 0.1% by weight in homogenous materials for lead, hexavalent chromium, mercury, PBB, PBDE, DBP, BBP, DEHP, DIBP, and 0.01% for cadmium, or qualify for an exemption to these limits as defined in the Annexes of Directive 2011/65/EU (RoHS2). Finished electrical and electronic equipment products will be CE marked as required by Directive 2011/65/EU. Components may not be CE marked. Additionally, the part numbers that TE has identified as EU ELV compliant have a maximum concentration of 0.1% by weight in homogenous materials for lead, hexavalent chromium, and mercury, and 0.01% for cadmium, or qualify for an exemption to these limits as defined in the Annexes of Directive 2000/53/EC (ELV). Regarding the REACH Regulation, the information TE provides on SVHC in articles for this part number is based on the latest European Chemicals Agency (ECHA) 'Guidance on requirements for substances in articles' posted at this URL: <https://echa.europa.eu/guidance-documents/guidance-on-reach>



Compatible Parts

 <p>TE Part # 350793-1 04P UMNL PIN HDR ASSY 94VO</p>	 <p>TE Part # 350826-4 04P UMNL HDR ASSY PC 94VO LF</p>	 <p>TE Part # 173926-1 4 P ACTION PIN UMNL</p>	 <p>TE Part # 350761-5 04P UMNL HDR ASSY PC LF</p>
--	--	---	---

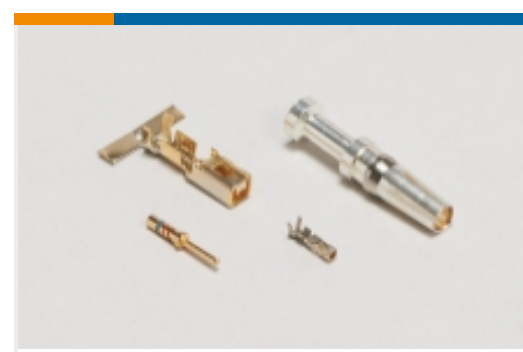

 <p>TE Part # 350793-3 04P UMNL PIN HDR ASSY 94VO LF</p>	 <p>TE Part # 770019-1 04P UMNLII IN-LNE PLUG HSG KIT</p>	 <p>TE Part # 350430-1 04P UMNL PIN HDR ASSY NATL</p>	 <p>TE Part # 350779-4 04P UMNL PLUG HSG UL94VO</p>
 <p>TE Part # 1-350944-0 04P UMNL HDR ASSY R/A 94VO</p>	 <p>TE Part # 350792-1 04P UMML PIN HDR ASSY 94VO</p>	 <p>TE Part # 641968-1 04P UMNL PIN HDR ASSY POL 94VO</p>	 <p>TE Part # 643415-1 04P UMNL HDR ASSY POL</p>
 <p>TE Part # 926298-3 04P UNIV.M-N-L.PLUG</p>	 <p>TE Part # 1586860-1 06P UMNL CAP HSG, GW</p>	 <p>TE Part # 350826-1 04P UMNL HDR ASSY PC 94VO</p>	 <p>TE Part # 643230-1 04P UMNL HDR ASSY R/A 94VO</p>
 <p>TE Part # 926298-6 UNML PLUG 4WAY</p>	 <p>TE Part # 350780-1 04P UMNL CAP HSG</p>	 <p>TE Part # 350779-1 04P UMNL PLUG HSG</p>	 <p>TE Part # 1586076-1 02P UMNL PIN HDR W/O DRNS V2</p>

Also in the Series | **Universal MATE-N-LOK**

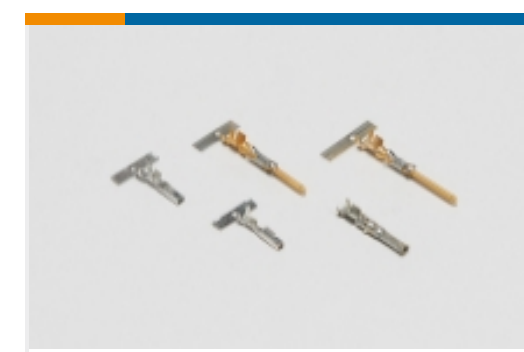
 <p>Circular Power Connectors(2)</p>	 <p>Connector Contacts(11)</p>	 <p>Insertion & Extraction Tools(4)</p>	 <p>Power Contacts(207)</p>
---	--	--	--



Rectangular Boots & Strain Relief(35)

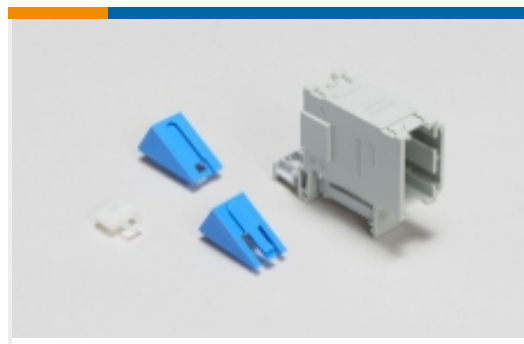

Rectangular Connector Adapters(7)



Rectangular Connector Hardware(1)



Rectangular Connector Housings(2)

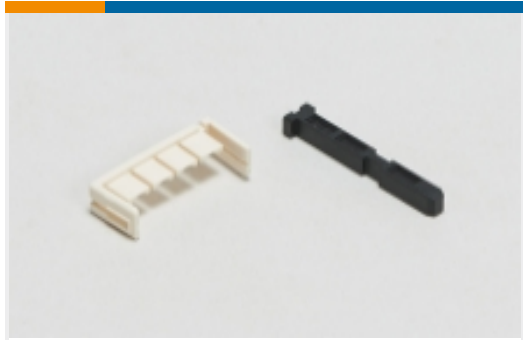

Rectangular Connector Keying Plugs(3)



Rectangular Connector Locking(4)

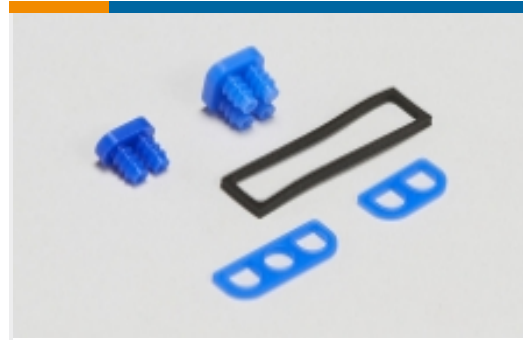

Rectangular Connector Seals(26)



Rectangular Power Connectors(729)

Customers Also Bought



TE Part #1586852-1
04P UMNL PLUG HSG, GW



TE Part #1586849-1
03P UMNL CAP HSG NATL, GW



TE Part #42617-1
187 FASTON REC 20-16 AWG BR



TE Part #1586847-1
03P UMNL PLUG HSG, GW



TE Part #1586851-1
02P UMNL PLUG HSG, GW



TE Part #42400-1
250 FASTON REC 18-14 AWG BR

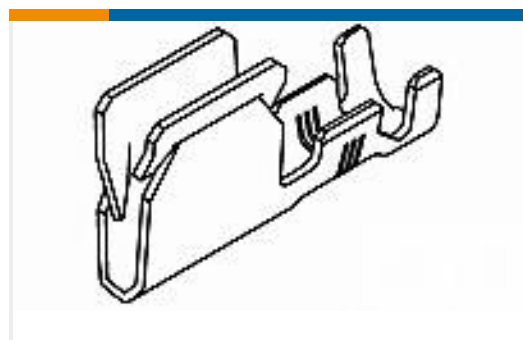

TE Part #63895-1
GROUND CLIP 14-18AWG ST



TE Part #63482-1
RING 18-14 AWG TPSTL



TE Part #40509
SPLICE 3300 TO 9000 CMA BR



TE Part #60772-1
RING CRIMP 18-14 AWG BR

Documents



Product Drawings

[04P UMNL CAP HSG NATL, GW](#)

English

CAD Files

Customer View Model

[ENG_CVM_1586845-1_A.3d_igs.zip](#)

English

Customer View Model

[ENG_CVM_1586845-1_A.3d_stp.zip](#)

English

Customer View Model

[ENG_CVM_1586845-1_A.2d_dxf.zip](#)

English

[3D PDF](#)

English

By downloading the CAD file I accept and agree to the [Terms and Conditions](#) of use.

Product Environmental Compliance

[MD_1586845-1_061220181033_dmtec](#)

English

[MD_1586845-1_061220181033_dmtec](#)

English

Agency Approvals

[CSA Certificate](#)

English